



buffet | tabletop | bar



- MG HOTEL SUPPLIES UAE
- +971 56 199 8131
- elias.a@mghotelsupplies.com
- [mg.supplies.uae](https://www.instagram.com/mg.supplies.uae)

SINCE 1933

2024
INTERNATIONAL
CATALOGUE

APS – Werkstatt und Bühne für den Genuss

APS – Workshop and stage for enjoyment



family-run company
since 1933

Reinhold Pott | Bastian Becker



- eigene Produktion in Deutschland
- 20.000 Euro-Palettenlagerplätze
- own production in Germany
- 20,000 Euro pallet storage spaces



buffet | tabletop | bar

Assheuer + Pott GmbH & Co. KG
Talweg 11 | 59846 Sundern
Germany

Phone: +49 (0) 2933 / 97 35 - 0
info@aps-germany.de
aps-germany.de



Visit our website!



Ihr Mehrwert: Inspiration & Service

- ✓ aktuellste Nonfood-Trends im Sortiment
- ✓ hohe Warenverfügbarkeit



Your added value: Inspiration & Service

- ✓ latest nonfood-trends in the range
- ✓ high availability of goods

p. 100



p. 110



p. 138



Buffet & Display

p. 176



p. 194



p. 232



Buffet & Tableware
Melamine

p. 258



p. 302



p. 318



Tableware &
Table Presentation

p. 358



p. 370



p. 374



Baskets

p. 390



p. 408



p. 414



Chafing Dish,
GN Container & Transport

p. 442



p. 456



p. 494



Bar, Café & Drinkware

p. 514



p. 530



p. 548



Kitchen & Servings tools

p. 563



p. 565



p. 568



Covers & Accessories

APS – KNOW-HOW

We only work with the raw material manufacturer who has the best technology in the industry.



MELAMINE

- ✓ 100 % pure melamine
- ✓ BPA free, urea free
- ✓ perfect for serving dishes
- ✓ extremely break and shock resistant
- ✓ sustainable due to durability and robustness
- ✓ hygienic surfaces
- ✓ environmentally friendly due to low processing temperature
- ✓ 100 % dishwasher safe
- ✓ useable up to max. 70 °C

STAINLESS STEEL

- ✓ hygienic surface
- ✓ durable and easy to clean
- ✓ recyclable
- ✓ good temperature conductor
- ✓ 100 % dishwasher safe



Chrome-nickel steel is used in a wide variety of products due to its attractive appearance, as a brightly polished, ground or brushed variant.

WOOD ACACIA - BEECH - OAK - OLIVE



PORCELAIN



PLASTIC PP - PS - SAN - TRITAN



- ✓ high resistance to heat
- ✓ durable, no disposable plastic
- ✓ crystal clear
- ✓ hygienic surface
- ✓ easy to clean
- ✓ recyclable
- ✓ BPA free

Präzisionsarbeit und Design für Ihren Erfolg

Precision work and design for your success



state-of-the-art
manufacturing
technology



eco-friendly



high
professional
usability

QUALITÄT

- ✓ Jedes Produkt muss mehr als zwei Qualitätskontrollen bestehen.
- ✓ Wir verwenden nur 100 % reines Material.
- ✓ Jedes Rohmaterial wird streng geprüft.

QUALITY

- ✓ Each product must pass more than two quality checks.
- ✓ We only use 100 % pure material.
- ✓ Each raw material is strictly tested.



APS production | Made in Germany

DESIGN

- ✓ Unsere eigenständig entwickelten Produkte verfügen über zahlreiche Design-Patente im In- und Ausland.
- ✓ Wir entwickeln Produktlösungen für jeden individuellen Kundenbedarf.

DESIGN

- ✓ Our independently developed products have rich / multi design patents at home and abroad.
- ✓ We develop product solutions for every individual customer need.



Design team

DEUTSCH

Artikel Seite

A

Abklappbehälter	416,493
Abräumwagen	426,427
Abtropfmatte	474
Adapter / Zwischensteg	418
Allzweckgießer	329,490
Antirutschmatte	18,454
Aschenbecher	506-509
Auflaufform	83
Aufstrichmesser	536
Auslagenplatte / Kuchenplatte	154,361
Ausgießer	329,480,481,490
Ausstellblech	154,361,545
Austernmesser	533

B

Backblech	143,423
Backform	544,552-553
Backhandschuhe	554
Baguette Korb	360,366
Bain-Marie	393-401,405,541
Bar-Caddy	474
Barlöffel	471
Barmaß	468-469
Barmatte	474
Barsieb	472,539
Becher	273,460-466,493,497
Becher Emaille	266
Behälter	89-91,350-355,432,473
Bento Box	227-228
Beschriftungsetiketten	71,346
Beschriftungskarten	344-349
Besteckablage	250,431
Besteckbehälter	23,89-91,350-355,362,381,428-430
Besteckkorb	353,367
Besteckständer	353
Bestecktaschen	325-326

Beton

	88,99,111,196-197,307,295,342,344,351,452,455,507
Bierglasträger	151,503
Bitterflasche	480
Blattschale Melamin	203,222,239,248
Bonleiste	558
Bonspieß	558
Bräter	80-82,480-410
Brennpastenbehälter Edelstahl	399
Brezel- oder Wurstständer	62
Brotstation	68
Brotkorb	43,68,358-366,368-369,370-373,374-379,380-384

Brötchenspende

Brötchenspende	68-70
----------------	-------

Brötchenspende Edelstahl

Brötchenspende Edelstahl	43
--------------------------	----

Brötchen

Brötchen	370-373
----------	---------

Buffet Box

Buffet Box	57-58
------------	-------

Buffet Kühlset

Buffet Kühlset	20,31,126,156
----------------	---------------

Buffet Kühlset Edelstahl

Buffet Kühlset Edelstahl	31
--------------------------	----

Buffet-Set

Buffet-Set	43,106,366,387
------------	----------------

Buffetbrett

Buffetbrett	72-74,124
-------------	-----------

Buffetgestell

Buffetgestell	29,43,59,106,366,387
---------------	----------------------

Buffetkorb

Buffetkorb	43,68,358-366,368-369,370-373,374-379,380-384
------------	---

Buffetleiter

Buffetleiter	104-105,108-109
--------------	-----------------

Buffetschilder

Buffetschilder	113,117,344-349
----------------	-----------------

Buffetständer

Buffetständer	17,54-56,67,73,93-94,95,99,102,228,241
---------------	--

Buffetständer Edelstahl

Buffetständer Edelstahl	228,241
-------------------------	---------

Buffetständer Holz

Buffetständer Holz	54-56,67,95,99,102
--------------------	--------------------

Buffetständer Metall

Buffetständer Metall	17,73,93-94,98
----------------------	----------------

Buffetvitrine

Buffetvitrine	32-34,41
---------------	----------

Buffetvitrine Edelstahl

Buffetvitrine Edelstahl	32-34
-------------------------	-------

Butterdose

Butterdose	313
------------	-----

Butterservierer

Butterservierer	312
-----------------	-----

Bürste Bar

Bürste Bar	481
------------	-----

C

Caddy

Caddy	169,311,355,474,487
-------	---------------------

Cappuccinotasse

Cappuccinotasse	137,333,495
-----------------	-------------

Cerealispender

Cerealispender	23,100-103
----------------	------------

Cerealispender Edelstahl

Cerealispender Edelstahl	23,100-103
--------------------------	------------

Chafing Dish

Chafing Dish	84-85,390-400,402-405
--------------	-----------------------

Chafing Dish Rolltop

Chafing Dish Rolltop	398,400,405
----------------------	-------------

Champagnerkühler

Champagnerkühler	446-447
------------------	---------

Cocktailmesser

Cocktailmesser	473,531
----------------	---------

D

Darioiform

Darioiform	545
------------	-----

Deckel

Deckel	38,40,104,251,278,417,421,554,572-574
--------	---------------------------------------

Deckel Edelstahl

Deckel Edelstahl	417-418
------------------	---------

Dekoriermesser

Dekoriermesser	473,533
----------------	---------

Dip-Schälchen

Dip-Schälchen	47,205,243-246,257,270-271
---------------	----------------------------

Dispenser Saft

Dispenser Saft	22,113,116,118,120
----------------	--------------------

Dispenser Milch

Dispenser Milch	22,116-117,120
-----------------	----------------

Dosier- & Vorratsflasche

Dosier- & Vorratsflasche	480,548-549
--------------------------	-------------

Dosierer Zucker

Dosierer Zucker	330-331,491-492
-----------------	-----------------

Dosierpumpe

Dosierpumpe	550
-------------	-----

Dosierspender

Dosierspender	550
---------------	-----

Dressingtopf Edelstahl

Dressingtopf Edelstahl	71
------------------------	----

Dressingtopf Melamin

Dressingtopf Melamin	71
----------------------	----

Dressingtopf Porzellan

Dressingtopf Porzellan	71
------------------------	----

E

Eier-Box

Eier-Box	432,550
----------	---------

Eierbecher

Eierbecher	250,313
------------	---------

Eierkorb

Eierkorb	361
----------	-----

Eierschneider

Eierschneider	537
---------------	-----

Eimer

Eimer	263,433,476-477,543
-------	---------------------

Eis-Kugel-Former

Eis-Kugel-Former	478
------------------	-----

Eisbox

Eisbox	26,476
--------	--------

Eiseimer

Eiseimer	443,476-477
----------	-------------

Eisportionierer

Eisportionierer	528,559
-----------------	---------

Eisschaufel

Eisschaufel	477
-------------	-----

Eiswaffel-Ständer

Eiswaffel-Ständer	559
-------------------	-----

Eiswasserröhre

Eiswasserröhre	110,124-125,454
----------------	-----------------

Eiswürfelform

Eiswürfelform	478
---------------	-----

Eiszange

Eiszange	479,523
----------	---------

Eiszerkleinerer

Eiszerkleinerer	477
-----------------	-----

Emaille-Artikel

Emaille-Artikel	201,266-267,313
-----------------	-----------------

Entkerner

Entkerner	532
-----------	-----

Espressotasse

Espressotasse	136,332,496
---------------	-------------

Etagère

Etagère	19,54-55,60-66,161,214,219
---------	----------------------------

F

Fadenschneider

Fadenschneider	530
----------------	-----

Fast-Food Tablett

Fast-Food Tablett	152,504
-------------------	---------

Feuerzangenbowle-Set

Feuerzangenbowle-Set	317,407
----------------------	---------

Fingerfood-Löffel

Fingerfood-Löffel	48,230,248-249
-------------------	----------------

Flambierbrenner

Flambierbrenner	559
-----------------	-----

Flasche

Flasche	122-125,299,274,480,482-483,548-549
---------	-------------------------------------

Flaschenhalter Wein

Flaschenhalter Wein	453
---------------------	-----

Flaschenkühler

Flaschenkühler	53,71,126,128,256,443-444,446-447,449-452,460,483
----------------	---

Flaschenöffner

Flaschenöffner	128,482
----------------	---------

Folien-Abreißvorrichtung

Folien-Abreißvorrichtung	558
--------------------------	-----

Fondue-Set

Fondue-Set	317,407
------------	---------

Frischhaltedeckel

Frischhaltedeckel	278
-------------------	-----

G

Gabel Fleisch

Gabel Fleisch	515,518-519
---------------	-------------

Gabel Salat

Gabel Salat	514,250,517,556
-------------	-----------------

Spitzsieb

Spitzsieb	539
-----------	-----

Gebäckpalette

Gebäckpalette	169
---------------	-----

Gebäckzange

Gebäckzange	525-528
-------------	---------

Gemüsehobel

Gemüsehobel	541
-------------	-----

Getränkspender

Getränkspender	18,111-115,455
----------------	----------------

Getränkewanne

Getränkewanne	127,447
---------------	---------

Gewürzstreuer

Gewürzstreuer	310
---------------	-----

Gläsereschiene

Gläsereschiene	465
----------------	-----

Glasumrandler

Glasumrandler	474
---------------	-----

Glocke

Glocke	505
--------	-----

Gourmetlöffel

Gourmetlöffel	273
---------------	-----

GN Abtropfgitter

GN Abtropfgitter	418,421
------------------	---------

GN Behälter

GN Behälter	49,139,251,414-416,419-425
-------------	----------------------------

GN Behälter Edelstahl

GN Behälter Edelstahl	139,414-416
-----------------------	-------------

GN Besteckbehälter

GN Besteckbehälter	23,90-91,362,428-429
--------------------	----------------------

GN Buffetgestell

GN Buffetgestell	366
------------------	-----

GN Buffetleiter

GN Buffetleiter	108-109
-----------------	---------

GN Buffetständer

GN Buffetständer	17,228
------------------	--------

GN Buffetvitrine Edelstahl

GN Buffetvitrine Edelstahl	31-34
----------------------------	-------

GN Chafing Dish

GN Chafing Dish	391,393-394,396,398-400
-----------------	-------------------------

GN Deckel

GN Deckel	251,417-419,421,424
-----------	---------------------

GN Haube

GN Haube	139,188,366,369,379,562-564
----------	-----------------------------

GN Korb

GN Korb	26,358-361,362-366,369,378,380
---------	--------------------------------

GN Korb Metall

GN Korb Metall	378,380
----------------	---------

Schaufel Eis	477	237,238,241,247,256,282,283,286,289,
Schaufel	287,477,547,553,556,557	290,292,316,329,361,423,425,492,
Schaufel Mehl	547	500-505
Schaumlöffel	516,521	Tablett Edelstahl 24,25,138,147,149,247,
Schaumspesering	544	256,292,316,500,501,502,505
Schiefer	16,28,30,31,62,63,156,156-161,	Tablett Fast Food 152,504
	165,166,218,220,284,288,289,304,386	Tablett Holz 24,45,65,68,96,148,163,282,
Schilder	344-346,386	283,286,290,329,492
Schlüsselschnur	483	Tablett Melamin 25,30,65,68,70,145,151,
Schneebesen	537	158,174,176,178,180,182,185,188,189,
Schneidbrettständer	559	190,191,192,197,198,199,200,
Schneidebrett	25,44,68,70,473	207,210,216,217,218,219,220,221,
Schöpflöffel	514,516,518,519,521	224,225,227,230,232,233,235,237,
Seiher	540	238,241,247,289,500,502,503
Sektglas	335,456	Teebox 133,487
Sektkühler	127,442-444,448,449	Teebrühsieb 492
Senftöpfchen	296	Teekanne ASIA 132,282,486
Servierbox	15,16,26,28-30,57,58,68,78,	Teigbehälter 432,554
	107,133,171,269,282,283,311,386,387	Teigschaber / Abstecher 536
Serviertöpfchen	149,260,261	Teigspachtel 545
Servier- / Tortenplatte Edelstahl	147,154	Teller Emaille 201,267
Servier- / Tortenplatte Holz	154	Teller Fingerfood 247
Servier- / Tortenplatte Melamin	153,240	Teller Melamin 96,112,175,176,177,178,
Servierbrett	162-169,171,281-288	180,181,182,186,191,193,194,199,200,
Servier-Frittierkorb	262	201,202,207,224,227,233,247
Serviergabel	515	Thermometer 489
Serviergestell	60-62,106,278	Thermo Tablett-Set 35
Servierkelle	269	Thermo-Set 37
Servierkorb	26,256,358-366,368,369,	Tin in Tin Shaker 466
	372-385	Tischrestebehalter 354-355
Servierlöffel	250,514,516,517-219,521	Tischschäufsteller 346,348
Servierpfanne	142,260,261	Tischkartenhalter 343-349
Servierpfanne Gusseisen	268	Tischkrümelentferner 315,505
Servierset	183	Tischleuchte 336-341,436-441
Serviertablett	143-145,151,163,283,	Tischsets 318-328
	292,501-503	Tortenheber 515,517
Servierwagen	426,427	Tortenmesser 517
Servierzange	526-529	Tortenplatte 147,153-154,160,240
Serviettenhalter	86-88	Tortenring 544
Serviettenringe	316	To-Go Becher 497
Serviettentaschen	325,326	Transportwagen 426,427,341,441
Shaker	463,466,467	Tretbeutelhalter 510
Sieb	472,492,538,539	Trichter 433,541,546
Snackbox	269,282	Trinkbecher 114-115,463,466,457-459
Snackholder	262-264	Trinkflasche 121,498-499
Snackpresenter	41	Trinkglas 113,459
Snackspender	273,464	Trinkhalme 475
Spachtel	536	Tropfenschale Melamin 112,115,455
Spaghettizange	521,523-526	U
Spargelzange	526	Universalbox 78
Sparschäler	531	Universalkanne 488-489
Speisenwärmer	51,406	Untersetzer Edelstahl 316
Spritzflasche	480,299	Untersetzer Kork 114-115
Standascher	509	Untersetzer Melamin 112
Ständer	17,62,67,73,92-95,98,99,102,103,	Untersetzer Naturschiefer 159,289,304
	106,215,228,241,293,295,301,344,347,	Untertasse 136-137,332-333,594-595
	541,559	Unterteller 112
Ständer Wein- / Sektkühler	445	V
Staubkappen	481	Vase 342
Stielglas	335	Verschluss Wein / Champagner 481
Stielkasserolle	258-261	Vorspeisenzange 524
Stift	346	Vorratsglas 76-78
Stößel	470	W
Stövchen	133,487	Wachspapier 143,159,169,264,282,292,500
Streichpalette	534	Wanne 25,127,432
Streuer	309-310,540	Warenträger 320
Streuer Pfeffer	309-310	Wärmebrücke 51,53,406
Streuer Salz	309-310	Wärme-Kies 405
Superbox	28-30,386-387	Warnschild 550,575
Suppenkelle	517	Wasserbadschüssel 541
Suppentopf	401	Wasserkanne 122-125
Sushiboard Holz	162,286	Wasserspender 110-115,454-455
Sushiboard Melamin	180,182,207	Weck Gläser 274-278,289
T		Weinglas 335,456
Table Caddy	169,311,355,474	Weinkühler 127,442-444,448-449
Tablett	19,24,25,30,45,49,52,54,55,60-66,	Weinkühlerständer 445
	68,70,96,138-147,143-145,148,149,	Wender 516,519-520,534-535
	151,152,158,161,163,174,176,178,180	Windaschenbecher 506-509
	182,185,188,189,190,191,192,197,198,	Windlicht 342
	199,200,207,210,214,216,217,218,219,	Z
	220,221,224,225,227,230,232,233,235,	Zange 479,521-529

ENGLISH

item	page
A	
adapter	418
air pot	129-131
airtight cover	278
appetizer tong	524
ashtray	506-509
asparagus tongs	526
B	
baguette basket	360,366
bain marie bailing bowl	541
Bain-Marie	393-401,405,541
baking mittens	554
baking pan	544,552-553
baking sheet	143,423
bar caddy	474
bar knife	473,531
bar spoon	471
bar strainer	539,472
barrel mug	273,460-466,493,497
basket metal	265,373-380,383-385
basket polypropylene	353,358-369
basket stainless steel	262-263,382-383
beaker	266
beer rack	151,503
Bento Box	227-228
beverage dispenser	18,111-115,455
beverage tub	127,447
bill presenter	316,505
bill rail	558
bill spike	558
bottle	122-125,299,274,480,
	482-483,548-549
bottle cooler	53,71,126,128,256,
	443-444,446-447,449-452,460,483
bottle fuel	399
bottle opener	128,482
bowl aluminium	53,265,373
bowl concrete	99
bowl enamel	266-267,313
bowl glass	104,105,574
bowl holder	106
bowl melamine	175,177-219,221,229,
	231-247,249,293
bowl stainless steel	79,142,257,263-264,
	272,383
bowl wood	96-98,164,170-171,
	280-281,285,290,291
bread basket	370-373
bread station	68
Breadbox	68,43,358-366,368-369,
	370-373,374-379,380-384
breeding set	551
bucket	263,433,476-477,543
buffet basket	68,43,358-366,368-369,
	370-373,374-379,380-384
buffet box	57-58
buffet ladder	104-105,108-109
buffet set	43,106,366,387
buffet signs	113,117,344-349
buffet stand	17,29,43,54-56,59,67,73,
	93-94,95,99,102,106,228,241,366,387
buffet stand metal	17,73,93-94,98
buffet stand stainless steel	228,241
buffet stand wood	54-56,67,95,99,102
buffet-board	72-74,124
butter dish	313
butter dish	312
C	
caddy	487,169,311,355,474
cake lifter	515,517
cake plate melamine	153,240
cake plate stainless steel	147,154
cake plate wood	154
cake setting ring	544
cake slice	517
cake stand	147,153-154,160,240
canale / decorating knife	531
canister	76-78
cap bowl	128
cappuccino cup	137,333,495
cast iron pan	268
caviar cooler	149
cereal dispenser	23,100-103
cereal dispenser stainless steel	23,100-103
Chafing Dish	84-85,390-400,402-405
Chafing Dish Rolltop	398,400,405
chalk marker	17,28,344,346,386
champagne bowl	127,442-444,
	446-447,448,449
champagne glass	335,456
champagne/wine saver	481
charging station	340-341,440-441
cheese dish	300-301
cheese slicer	533
chefs blow torch	559
chopping board	25,44,68,70,473
citrus squeezer	484,551
cleaning brush	475,481
clingfilm tear-off dispenser	558
cloche / dome cover	505
coaster cork	114-115
coaster melamine	112
coaster natural slate	159,289,304
coaster stainless steel	316
coffee cup	266,497
coffee dispenser stainless steel	129-131,413
coffee pot	489
concrete	88,111,295,351,507,99,
	196-197,307,342,344,452,455
condiment holder	473
confectionery funnel	541
conference bottle cooler	483
conical strainer	539
container	89-91,25,127,350-355,432,473
cooking pot with lid	81-82,409-410
cool collar	453
cooler	21,32-40,128,156,575
cooling bowl	21,38-40
cooling box	20,31-40,126,156
cooling box stainless steel	31
cooling carafe	124-125
cooling plates	24,31,36
corer	532
corkscrew	483
cornet stand	559
cover	38-40,104,251,278,417,421,
	379,405,562-571,24-27,
	31-37,45,67,72,74,138-142,
	146-149,155,160-161,188,211,241,
	365-366,369,554,572-574
cover holder	45
cover stainless steel	417-418
crochet rope basket	372
crumber	315,505
curler	62,533,541
cutlery bag	325-326
cutlery basket	353
cutlery dispenser	353,367
cutlery organizer	23,89-91,350-355,362,
	381,428-430
cutlery rest	250,431
cutting board	68-70
cutting board rack	559
D	
Dario! moulds	545
decorating knife	473,533
decorator / zester	530
delicatessen spoon	555
designation cards	344-349
dip bowl	47,205,243-246,257,270-271

dispenser	550
dispenser sugar	330-331,491-492
display	320
display plate	154,361
display tray	361,154,545
dosing pump	550
dough container	432,554
dough spatula	545
dough scraper	536
dressing pot melamine	71
dressing pot porcelain	71
dressing pot stainless steel	71
dressing/sauce spoon	515,555
drinking bottle	121,498-499
drinking cups	113, 457-459, 114-115,463, 459,466
drip mat	474
drip tray melamine	112,115,455
dust & fly cap	481
E	
egg basket	361
egg cutter	537
egg holder	250,313
eggs box	432,550
enamel articles	201,266-267,313
espresso cup	136,332,496
F	
fingerfood plate	247
fire punch bowl set	317,407
flower vase	342
fondue set	317,407
fork	515
free flow pourer	481
fry baskets	262
fry dripping tray	540
funnel	433,541,546
G	
glass carafe	122-126
glass rack	465
glass rimmer	474
GN basket	26,358-361, 362-366,369,378,380
GN basket metal	378,380
GN basket polypropylene	358-366,369
GN bowl melamine	175,179,185,213
GN buffet display stainless steel	31-34
GN buffet ladder	108-109
GN buffet stand	17,228,366
GN Chafing Dish	391,393-394,396,398-400
GN cover	139,188,366,369,379, 562-564
GN cutlery organizer	23,90-91,362,428-429
GN grid	423
GN natural slate tray	16,30,157
GN pan stainless steel	139,414-416
GN party tray	150
GN serving board	503
GN serving stand	27
GN tray	25,30,52,138-139,174,176, 180,185,188,190,192,197,198, 216,217,218-219,227, 235, 237-238,247,423
GN tray melamine	30,174,176,180,185, 188,190,192,197,198,216,217, 218-219,227,235,237-238
GN tray porcelain	423,25
GN tray stainless steel	138-139,247
GN-container	414-416,419-425,49,139,251
GN-drainer	418,421
GN-lid	251,417-419,421,424
gourmet glasses	277
graduated jug	542-543
granite chips	405
gravy boat	314,315
greaseproof paper squares	169,143,159, 264,282,292,500
H	
heating unit	18,85,129,398-399,403,404,413
honey spoon	557
hygienic cover	17,42,43,62
I	
ice ball former	478
ice box	26,476
ice bucket	443,476-477
ice cream scoop	528,559
ice crusher	477
ice cube cooling tube	110,124-125,454
ice cube maker	478
ice scoop	477
ice tongs	479,523
induction plate	85,390-397,403-404
induction station	18,85,403
insulated dispenser	118
J	
jigger	468-469
jug	488-489
juice dispenser	22,113,116,118,120
juice pitcher	122-125,247
K	
key cord	483
L	
labeling labels	71,346
labels	344-346,386
ladle	514,516,518,519,521
leaf melamine	203,222,239,248
lemon slice squeezer	493
lime press	484,551
lobster cracker	537
lunchbox	511
M	
magnetic knife rack	558
mandolin	541
meat fork	515,518-519
melon baller	530
menage	294-302,308
milk dispenser	22,116-117,120
milk jug	329,490,492
mini bowl	47,106,242,244-249,329,490,492
mixing glass	480
Moscow Mule barrel mug	460-462
mousse ring	544
muddler	470
multi rack stainless steel	75
multibox	133
mussel pot	293
mustard glass	296
N	
napkin bag	325,326
napkin holder	86-88
napkin rings	316
natural slate tray	16,30-31,63,149,156- 161,165-166,284,288-289,304
non slip mat	18,454
oyster knife	533
P	
pan	142,260-261,411
party spoon	48,230,248-249,273
partytray	150
pastry spatula	169
pastry tongs	525-528
pedal bin	510
peeler	531
pen	346
pepper mill	301-309,310
pitcher	117,122-125,129-134, 263,412,485-489,492
pizza cutter	532,537,554
pizza dish	552-553
pizza dough container	432,554
pizza peel	553
placemat	318-325
plate enamel	201,267
plate melamine	96,112,175,176,177,178, 180,181,182,186,191,193,194,199,200,201, 202,207,224,227,233,247
plate tray	315
plate warmer	51,406
podest	17,18,123
porcelain	84,136-137,332-333,394,397, 402,494-495
pourers	329,480,481,490
pouring container	480,548-549
pretzel-/ sausage stand	62
R	
refrigerated buffet display	20,31,126,156
reusable cup	497
ring bell	505
roll dispenser stainless	43
rolltop cover	20,24,26-27,31-37,74, 142,149,160,241,330, 365-366, 405,492,565-566
rolltop set	16,149
rolltop-cover stainless steel	405
S	
salad fork	250,514,517,556
salad spoon	250,514,517,556
salad spoon + fork	250,514,517, 521,524-52,556
salad tongs	25,521,524-527
salt mill	301-309,310
samovar	134,412,485
sandwich knife	536
saucer	112,136-137,332-333,594-595
sauté pan / mini sauce pan	258-261
scoop	287,477,547,553,556,557
scoop flour	547
scraper	536
service trolley	426,427,341,441
serving basket	26,256,358-366, 368,369,372-385
serving board	162-169,171,281-288
serving box	15,16,26,28-30,57,58,68, 78,107,133,171,269,282,283,311,386,387
serving cup	262-264
serving set	183
serving spoon	514,516,517-219,521,250
serving stand	17,60-62,67,73, 92-95,98,99,102,103,106,215,228,241, 278,293,295,301,344,347,541,559
serving tongs	526-529
serving trolley	426,427
serving trowel	269
set measuring spoon	528
shaker	309-310,463,466,467,540
showcase	32-34,41
showcase stainless steel	32-34
skimmer	516,521
skimmer spoon	539
slate	16,28,30,31,62,63,156,156-161,165, 166,218,220,284,288,289,304,386
small serving pot	149,260,261
snack dispenser	273,464
snack tray	152,504
snackbox	269,282
snackpresenter	41
snap mesh tea ball	492
soup ladle	517
soup pot	401
spaghetti spoon	516,521,524
spaghetti tongs	521,523-526
spatula	534
spice shaker	310
spider spoon	539
spoon	48,183,230,248-250,273,300, 431,471,514-521,528,539,555-557
spoon rest	431
spray bottle	480
squeeze bottle	299,548-549, 480
stainless steel frame for induction plate	393-395,404
stand for wine / champagne bowl	445
standing ashtray	509
stirring cup	543
strainer	472,492,538,539,540
straws	475
sugar dispenser	329-331, 491-492
sugar pot	492
superbox	28-30,386-387
sushiboard melamine	180,182,207
sushiboard wood	162,286
swivel peeler	531-532
T	
table caddy	169,311,355,474
table garbage bin	354-355
table lamp	336-341,436-441
table mats	318-328
table stands	343-349, 346,348
tapping container	416,493
tea-box	133,487
teapot ASIA	132,282,486
teapot warmer	133,487
thermal bridge	51,53,406
thermo set	37
thermo tray	35
thermometer	489
To-Go cup	497
tong	479,521-529
tray	19,24,25,30,45,49,52,54,55,60-66, 68,70,96,138-147,143-145,148,149, 151,152,158,161,163,174,176,178,180, 182,185,188,189,190,191,192,197,198, 199,200,207,210,214,216,217,218,219, 220,221,224,225,227,230,232,233,235, 237,238,241,247,256,282,283,286,289, 290,292,316,329,361,423,425,492, 500-505
tray melamine	25,30,65,68,70,145,151, 158,174,176,178,180,182,185, 188,189,190,191,192,197,198,199,200, 207,210,216,217,218,219,220,221,224, 225,227,230,232,233,235,237,238,241, 247,289,500,502,503
tray stainless steel	500,501,502,505, 24,25,138-147,149,247,256,292,316
tray wood	24,45,65,68,96,148,163,282, 283,286,290,329,492
trolley	341,426-427,441
turner	515,52, 516,519-520,534-535
tweezer	479,529
U	
universal box	78
V	
vacuum jug	129-131
W	
waiter's corkscrew	482
warning sign	550,575
water pitcher	122-125
Weck-bottles	274-278,289
whisk	537
wind lights / candle holder	342
wine bowl	127,442-444, 448-449
wine glass	335,456
winebottle-stand	453
woodbox	15,171,283,311,386-387
 ESPAÑOL	
artículos	pág.
A	
abre ostras	533
abridor	128,482
acumulador de frío	21,32-40,128,156,575
adaptador	418
aro anti-goteo melamina	112,115,455
aro de tarta	544
aro redondo para semifríos	544
artículos esmaltados	201,266-267,313
azucarero	330-331,491-492
B	
bajo plato	315
bandeja	19,24,25,30,45,49,52,54,55, 60-66, 68,70,96,138-147,143-145, 148,149,151,152,158,161,163,174,176, 178,180, 182,185,188,189,190,191, 192,197,198,199,200,207,210,214,216, 217,218,219,220,221,224,225,227,230, 232,233,235,237,238,241,247,256,282, 283,286,289,290,292,316,329,361,423, 425,492,500-505

bandeja acero inoxidable	24,25,138-147, 149,247,256,292,316, 500,501,502,505	cenicero de pie	509	dispensador de cereales acero inoxidable	23,100-103	GN soporte buffet	27,366
bandeja autoservicio y snacks	152,504	cepillo de limpieza	475,481	dispensador de film	558	GN soporte para buffet	17,228
bandeja con alturas	19,54-55,60-66, 161,214,219	cesta acero inoxidable	262-263,382-383	dispensador de leche	22,116-117,120	GN tabla de servir	503
bandeja de pizarra natural	16,30-31,63, 149,156-161,165-166,284,288-289,304	cesta de baquette	360,366	dispensador de salsa	550	GN tapa	251,417-419,421,424
bandeja isotérmica	37	cesta de buffet	43,63,358-366,368-369, 370-373,374-379,380-384	dispensador de snacks	273,464	granulado térmico	405
bandeja madera	24,45,65,68,96,148,163, 282,283,286,290,329,492	cesta de cuerda de ganchillo	372	dispensador de zumo	22,113,116,118,120	H	
bandeja melamina	25,30,65,68,70,145, 151,158,174,176,178,180,182,185,188, 189,190,191,192,197,198,199,200,207, 210,216,217,218,219,220,221,224,225, 227,230,232,233,235,237,238,241,247, 289,500,502,503	cesta de huevos	361	dispensador de panecillos acero inoxidable	43	hormigón	88,111,295,351,507,99, 196-197,307,342,344,452,455
bandeja para sushi melamina	180,182,207	cesta metal	265,373-380,383-385	dispensador en escalera acero inoxidable	75	huevo	250,313
bandeja party	150	cesta para servir	26,256,358-366,368,369, 372-385	dispensador isotérmico	118	I	
bandeja pastelera	154,423,143,361,545	cesta polipropileno	353,358-369	embudo	433,541,546	infusor de té, pinza con malla	492
bandeja tartas acero inoxidable	147,154	cestitas para el servicio mesa	262	embudo dosificador	541	J	
bandeja tartas madera	154	Chafing Dish	84-85,390-400,402-405	enfriador de botellas	53,71,126,128, 256,443-444,446-447,449-452,460,483	jarra	122,124-126,117,122-125, 129-134,263,412,453,488-489,492
bandeja tartas melamina	153,240	Chafing Dish Rolltop	398,400,405	enfriador de caviar	149	jarra de agua	122-125
bandeja termo	35	champañera	446-447	enfriador múltiple	483	jarra de leche	329,490,492
bandejas refrigeradas	24,31,36	colador	463,466,467	escurridor de fritos	540	jarra de vidrio	122-126
baño María	393-401,405,541	colador cónico	472,492,538,539,540	espátula	516,519-520,534-535,515,52	jarra de zumo	122-125,247
barra magnética para cuchillos	558	colador de cóctel	472,539	espátula masa	545	jarra enfriadora	124-125
barreño botellines	127,447	conjunto aperitivo	294-302,308	espátula plancha	536	jarra graduada	542-543
batidor	537	contenedor knock-out	416,493	espumadera	516,521	jarra termo	129-131
Bento Box	227-228	copa de champán	335,456	espumadera para fritos	539	juego de cucharas medidoras	528
bol refrigerado	21,38-40	copa de vino	335,456	estación de carga	340-341,440-441	L	
bolsa cubiertos	325-326	corta huevos	537	estación de empanado	551	lámpara de mesa	336-341,436-441
bolsa de servilletas	325,326	corta pasta	536	estación de inducción	18,85,403	llavero enrollable	483
bomba dosificadora	550	cortador de pizza	532,537,554	estación pan	68	M	
bote	76-78	cube	25,127,432	esterilla antideslizante	18,454	mandolina	541
bote de mostaza	296	cubierta higiénica antialiento	17,42,43,62	esterilla escurridora	474	manoplas de panadero	554
bote dosificador flexible	548-549	cubitera	26,476	etiquetas	71,346,344-346,386	mantelín	318-328
bote vertedor universal	329,490	cubitera isotérmica	443,476-477	expositor	320	mantequera	313
botella	122-125,299,274,480, 482-483,548-549	cubitera para cava	127,442-444,448,449	expositor buffet	29,43,59,106,366,387	mantequillera	312
botella „store & pour”	480,548-549	cubitera para vino	127,442-444,448,449	expositor buffet frío	20,31-40,126,156	marco de acero inoxidable para placa de inducción	393-395,404
botella de combustible líquido	399	cubo	369	expositor buffet frío acero inoxidable	31	marco pastelero	544,552-553
botella exprimible	480,299	cuchara	48,183,230,248-250, 273,300,431,471,514-521,528,539,555-557	expositor de buffet	17,54-56,67,73, 93-94,95,99,102,228,241	marmita	401
botes especieros	310	cuchara de espaguetis	516,521,524	expositor de buffet acero inoxidable	228,241	medidor jigger	468-469
C		cuchara de miel	557	expositor de buffet madera	54-56,67, 95,99,102	mejillonera	293
caballetes buffet	113,117,344-349	cuchara gourmet	273,555	expositor de buffet	17,73,93-94,98	molde de cubitos de hielo esféricos	478
caballetes de mesa	346,348	cuchara para ensalada	250,514,517,556	expositor para tartas	154,361	molde de pizza	552-553
cacerola	142,260-261,411	cuchara para helado	528,559	exprimidor cítricos	551,484	molde para cubitos de hielo	478
caddy	169,311,355,474,487	cuchara para hornear	539	F		molinillo de pimienta	301-310
caddy de mesa	169,311,355,474	cuchara para servir	250,514,516,517-519,521	fiambarrera	511	molinillo de sal	301-310
cafetera	489	cuchara party	48,230,247,248-249	flaneras	545	mortero	470
caja comida	15,16,26,28-30,57,58,68, 78,107,133,171,269,282,283,311,386,387	cucharilla de cóctel	471	florero	342	Moscow Mule taza	460-462
caja de buffet	57-58	cucharón	514,516,518,519,521	fuelle en forma de hoja melamina	203,222,239,248	multibox	133
caja de pan para buffet	68,43,358-366, 368-369,370-373,374-379,380-384	cucharón de salsa/aliño	515,555	fuelle para la mesa	260,261,142	O	
caja dispensadora	78	cucharón de sopa	517	funda de frío	453	olla con tapa	81-82,409-410
caja madera	15,171,283,311,386-387	cuchillo acanalador	473,533	G		olla pequeña de servir	149,260,261
caja para huevos	432,550	cuchillo de decoración cincelador	530,531	GN bandeja	25,30,52,138-139,174, 176,180,185,188,190,192,197, 198,216,217,218-219,227,235, 237-238,247,423	organizador de bar	474
caja para té	133,487	cuchillo para cóctel	473,531	GN bandeja acero inoxidable	138-139,247	P	
calentador de tetera	133,487	cuchillo para untar	536	GN bandeja de pizarra natural	16,30,157	pajas	475
caliente platos	51,406	cuenco para untar	536	GN bandeja melamina	30,174,176, 180,185,188,190,192,197,198,216,217, 218-219,227,235,237-238	pala	287,477,547,553,556,557
campana	24-27,31-37,45,67,72,74, 138-142,146-149,155,160-161,188, 211,241,365-366,369,379,405,562-571	cuenco acero inoxidable	79,142,257, 263-264,272,383	GN bandeja party	150	pala de hielo	477
campana esférica	505	cuenco aluminio	53,265,373	GN bandeja porcelana	25,423	pala de pizza	553
campana rolltop	20,24,26-27,31-37, 74,142,149,160,241,330, 365-366,405,492,565-567,565-566	cuenco de vidrio	104,105,574	GN campana	139,188,366,369,379,562-564	pala de tartas	515,517
campana rolltop acero inoxidable	405	cuenco esmaltado	266-267,313	GN cesta metal	378,380	pala para harina	547
candelabro	274	cuenco hormigón	99	GN cesta polipropileno	358-366,369	paleta para servir	269
cantimplora	121,498-499	cuenco madera	96-98,164,170-171, 280-281,285,290,291	GN Chafing Dish	391,393-394,396,398-400	paleta pastelera	169
carro	341,426-427,441	cuenco melamina	175,177-219,221,229, 231-247,249,293	GN cubeta	30,25,49,139,251, 414-416,419-425	panera	370-373
carro de servicio	331,426,427,441	cuenco mini	47,106,242,244-249, 329,490,492	GN cubeta acero inoxidable	139,414-416	papel alimenticio	169,143, 159,264,282,292,500
cazo para baño maría	541	cuenco para chapas	128	GN cuenco melamina	175,179,185,213	papelera de sobremesa	354-355
cazo recto bajo	258-261	cuenco para dip	47,205,243-246, 257,270-271	GN dispensador buffet en escalera	108-109	pedestal	17,18,123
cenicero	506-509	D		GN escurridor	418,421	pedestal reversible	531-532
		descorazonador	532	GN expositor buffet acero inoxidable	31-34	picadora de hielo	477
		dispensador buffet en escalera	104-105, 108-109	GN porta cubiertos	23,90-91,362,428-429	pie porta champañera / vino	445
		dispensador de bebidas	18,111-115,455	GN rejilla	423	pie porta vino	445
		dispensador de bocadillos	41			pinchanotas	558
		dispensador de café acero inoxidable	413, 129-131			pinza	479,521-529
		dispensador de cereales	23,100-103			pinza bogavante	537

pinza para espárragos	526
pinza para pasteles	525-528
pinza universal	526-529
pizarra	16,28,30,31,62,63,156,156-161,165,166,218,220,284,288,289,304,386
placa de inducción	85,390-397,403-404
platicillo	112,136-137,332-333,594-595
plato esmaltado	267,201
plato melamina	96,112,175,176,177,178,180,181,182,186,191,193,194,199,200,201,202,207,224,227,233,247
plato para el aperitivo	247
polvoreador	540,309-310
porcelana	84,136-137,332-333,394,397,402,494-495
porcionador de pastel	517
porta cubierto	23,89-91,350-355,362,367,381,428-430
porta cuenta	316,505
porta menú	343-349
porta vasos de cerveza	151,503
portafichas	558
porta-tarjetas	343-349
portavelas antiviento	342
posavasos acero inoxidable	316
posavasos corcho	114-115
posavasos melamina	112
posavasos pizarra natural	159,289,304
prensa de limón	484,551
punto térmico	51,53,406
pulverizador licores	480
Q	
quesera parmesano	300-301
R	
rack de copas	465
rack dispensador de cuencos	106
rebanador de queso	533
recipiente de ingredientes	473
recipiente organizador	350-355,432,473,89-91
recipiente para masa	554,432
recipiente para masa y bolas de pizza	432,554
recogemigas	315,505
reposa cuchara	250,431
resistencia	18,85,129,398-399,403,404,413
ribeteador de vasos	474
rizador	62,533,541
rotulador	346
rotulador de tiza	17,28,344,346,386
S	
sacacorchos	483
sacacorchos de camarero	482
salsera	314,315
salsera acero inoxidable	71
salsera melamina	71
salsera porcelana	71
samovar	134,412,485
sartén de hierro fundido	268
señal de advertencia	550,575
Servidor de ensalada	250,514,517,521,524-52,556
servilletero	86-88
servilleteros/aros	316
set de buffet	43,106,366,387
set de buffet refrigerado	20,31,126,156
set para fondue	317,407
set para ponche caliente	317,407
set para servir	183
set rolltop	16,149
snackbox	269,282
soplete de cocina para flambeo	559
soporte	17,55,62,67,73,92-95,98,99,102,103,106,215,228,241,293,295,301,344,347,541
soporte a pedal	510

soporte campana	45
soporte cucuruchos	559
soporte de pretzels o salchichas	62
soporte para botella de vino	453
soporte para pastel	147,153-154,160,240
soporte para tablas de cortar	559
soporte platos	60-62,106,278
superbox	28-30,386-387
T	
tabla de corte	68-70
tabla de servir	162-169,171,281-288
tabla para cortar	25,44,68,70,473
tabla para el buffet	72-74,124
tapa	38-40,104,251,278,417,421,554,572-574
tapa acero inoxidable	417-418
tapa hermética	278
tapete escurridor	474
tapón antipolvo	481
tapón vertedor	481
tarjetas	344-349
tarros gourmet	277
taza	273,460-466,493,497
taza de café	266,497
taza de cappuccino	137,495,333
taza de espresso	136,332,496
tenedor de carne	515,518-519
tenedor de ensalada	250,514,517,556
tenedor de servicio	515
termómetro	489
tetera ASIA	132,282,486
timbre	505
tubo enfriador para cubitos	110,124-125,454
V	
vaciador de melón redondo	530
vaso	113,459
vaso agitador	543
vaso coctelero	266
vaso mezclador vertedor	480
vaso para servir	262-264
vaso reutilizable	497
vaso To-Go	497
vasos	114-115,457-459,463,466
vertedor continuo	481
vertedores	329,480,481,490
vitrina de buffet	32-34,41
vitrina de buffet acero inoxidable	32-34
W	
Weck-botellas	274-278,289

FRANÇAIS

item	pág.
A	
accumulateur de froid	21,32-40,128,156,575
adaptateur	418
anneau coupe-gouttes mélamine	112,115,455
anneaux à serviettes	316
ardoise	16,28,30,31,62,63,156,156-161,165,166,218,220,284,288,289,304,386
articles en émail	201,266-267,313
assiette de présentation	315
assiette émail	201,267
assiette mélamine	96,112,175,176,177,178,180,181,182,186,191,193,194,199,200,201,202,207,224,227,233,247
assiette pour apéritif	247
B	
bac	25,127,432
bac knock-out	416,493
Bain-Marie	393-401,405,541
barre aimantée pour couteaux	558
barre porte-bons	558
base bois	15,171,283,311,386-387

bassine à glace	127,447
Bento Box	227-228
béton	88,111,295,351,507,99,196-197,307,342,344,452,455
beurrer	312,313
boîte à ingrédients	473
boîte à lunch	511
boîte à œufs	432,550
boîte à pain pour le buffet	68,43,358-366,368-369,370-373,374-379,380-384
boîte à thés et infusions	133,487
boîte de buffet	57-58
boîte distributrice	78
boîte-repas	15,16,26,28-30,57,58,68,78,107,133,171,269,282,283,311,386,387
bol acier inox	79,142,257,263-264,272,383
bol aluminium	53,265,373
bol béton	99
bol bois	96-98,164,170-171,280-281,285,290,291
bol émail	266-267,313
bol en verre	104,105,574
bol mélamine	175,177-219,221,229,231-247,249,293
bol mélangeur	266
bol mini	47,106,242,244-249,329,490,492
bol récupérateur de capsules	128
bol réfrigéré	21,38-40
bordeur à verres	474
bouchon anti-poussières et anti-insectes	481
bouchons verseurs	329,480,481,490
boule à thé avec pince	492
bouteille	122-125,299,274,480,482-483,548-549
bouteille store & pour	480,548-549
bouteille de combustible liquide	399
bouteille isotherme	129-131
bouteille verseuse souple	548-549
brosse lave	481,475
broyeur à glaçons	477
C	
caddy	487,169,311,355,474
caddy de table	169,311,355,474
cadre support inox pour plaque induction	393-395,404
caisson thermo	35
carafe en verre	122-126
casserole	142,260-261,411
casserole à moules	293
cendrier	506-509
cendrier sur pied	509
cercle à gâteaux	544
cercle à mousse rond	544
Chafing Dish	84-85,390-400,402-405
Chafing Dish Rolltop	398,400,405
chalumbeau e cuisine	559
chariot	341,426-427,441
chariot de service	426,427,341,441
chauffe-plat	51,406
chauffe-théière	133,487
chevalets de table	346,348
chinois	539
cloche	24-27,31-37,45,67,72,74,138-142,146-149,155,160-161,188,211,241,365-366,369,379,405,562-571
cloche demi-sphère	505
cloche rolltop	20,24,26-27,31-37,74,142,149,160,241,330,365-366,405,492,565-567
cloche rolltop acier inox	405
coquetier	250,313
corbeille	370-373
corbeille à baguette	360,366
corbeille acier inox	262-263,382-383

corbeille de buffet	68,43,358-366,368-369,370-373,374-379,380-384
corbeille de service	26,256,358-366,368,369,372-385
corbeille métal	265,373-380,383-385
corbeille polypropylène	353,358-369
coupe-œufs	537
coupe-pâte	536
coupe-pizza	532,537,554
couteau à huitres	533
couteau à tarte	517
couteau à tartiner	536
couteau cannelé	473,533
couteau cocktail	473,531
couteau tranche-fromage	533
couteau zesteur	530
couteau zesteur cannelé	531
couvercle	38-40,104,251,278,417,421,554,572-574
couvercle acier inox	417-418
couvercle hermétique	278
couvert à salade	250,514,517,521,524-52,556
cuillère	48,183,230,248-250,273,300,431,471,514-521,528,539,555-557
cuillère à cocktail	471
cuillère à glace	528,559
cuillère à miel	557
cuillère à salade	250,514,517,556
cuillère à sauce	515,555
cuillère à spaghetti	516,521,524
cuillère de service	250,514,516,517-219,521
cuillère gourmet	273,555
cuillère party	48,230,247,248-249
cuillère pâtisserie	539
D	
décapsulateur	128,482
dénoyauteur	532
dérouleur de film	558
distributeur de petits pains acier inox	43
distributeur à jus	22,113,116,118-120
distributeur à lait	22,116-117,120
distributeur de boisson isothermique	118
distributeur de boissons	18,111-115,454,455
distributeur de café acier inox	129-131,413
distributeur de céréales	23,100-103
distributeur de céréales acero inox	23,100-103
distributeur de snacks	273,464
doseur à sauce	550
E	
écumoire	516,521
égouttoir à friture	539-540
entonnoir	433,541,546
entonnoir à piston	541
étagère	19,54-55,60-66,161,214,219
étiquettes	71,346,344-346,386
F	
flacon pulvérisateur	299,480
flûte à champagne	335,456
forme à gateaux	544,552-553
fouet	537
fourchette à salade	250,514,517,556
fourchette à viande	515,518-519
fourchette de service	515
frisette	62,533,541
G	
gants de boulanger	554
GN bac	30,25,49,139,251,414-416,419-425
GN bac acier inoxydable	139,414-416
GN bol mélamine	175,179,185,213
GN Chafing Dish	391,393-394,396,398-400
GN cloche	139,188,366,369,379,562-564
GN corbeille	26,358-361,362-366,369,378,380
GN corbeille métal	378,380

GN corbeille polypropylène	358-366,369	pichet à lait	329,490,492	pot	76-78	support	17,62,67,73,92-95,98,99,102,103, 106,215,228,241,293,295,301,344,347, 541,559
GN couvercle	251,417-419,421,424	pichet gradué	542-543	pot à épices	309-310,540	support à bretzel ou à saucissons	62
GN égouttoir	418,421	pichet rafraîchisseur	124-125	pot à sauce acier inox	71	support à cornets	559
GN grille	423	pied pour seau à champagne / vin	445	pot à sauce mélamine	71	support cloche	45
GN planche de service	503	pied pour seau à vin	445	pot à sauce porcelaine	71	support multiple acier inox	75
GN plateau	25,30,52,138-139, 174,176,180,185, 188,190,192,197,198,216,217,218-219, 227,235,237-238,423,247	pilon muddler	470	pot de moutarde	296	T	
GN plateau acier inox	138-139,247	pince	479,521-529	pot verseur universel	490,329	tamis	472,492,538,539
GN plateau ardoise naturelle	16,30,157	pince à apéritif	524	poubelle à pédale	510	tamis cocktail	472,539
GN plateau buffet acier inox	31-34	pince à asperges	526	poubelle de table	354-355	tapis antidérapant	18,454
GN plateau mélamine	30,174,176,180, 185,188,190,192,197,198,216,217, 218-219,227,235,237-238	pince à dresser	479,529	présentoir à assiettes	60-62,106,278	tapis de bar	474
GN plateau party	150	pince à gâteaux	525-528	présentoir	320	tapis égouttoir	474
GN plateau porcelaine	25,423	pince à glaçons	479,523	présentoir à gâteaux	147,153-154, 160,240,361	tasse à café	266,497
GN présentoir buffet	17,228,366	pince à homard	537	présentoir à sandwiches	41	tasse à cappuccino	137,333,495
GN présentoir buffet en escalier	108-109	pince à salade	25,521,524-527	présentoir buffet	29,43,59,106,366,387, 17,54-56,67,73,93-94,95,99,102,228,241, 43,106,366,387	tasse à espresso	136,332,496
GN range couverts	23,90-91 362,428-429	pince à spaghetti	521,523-526	présentoir buffet acier inox	228,241	tasse à remuer	543
GN support buffet	27	pince universelle	526-529	présentoir buffet bois	54-56,67,95,99,102	tasse réutilisable	497
gobelet	113,273,460-466, 493,497,459	pince presse citron	493	présentoir buffet en escalier	104-105,108-109	tasse To-Go	497
gobelet à apéritif	262-264	pique-bons	558	présentoir buffet froid	20,31-40,126,156	théière ASIA	132,282,486
gobelets	457-459,114-115,463,466	pissette p. liqueurs	480	présentoir buffet froid acier inox	31	thermomètre	489
gourde	121,498-499	planche à découper	25,44,68,70,473	présentoir buffet métal	17,73,93-94,98	tire-bouchons	482,483
gravier thermique	405	planche à découper buffet	72-74,124	presse citron	484,551	tube de service	269
H		planche de service	162-169,171,281-288	R		tube pour glaçons	110,124-125,454
housse isotherme	453	plaque à induction	85,390-397,403-404	rack porte-verres	465	V	
J		plaque à pâtisserie	143, 545,361,154, 423	rack pour planches à découper	559	vase soliflor	342
jeu de cuillère à mesure	528	plat à gâteau acier inox	147,154	rafraîchisseur	483	verre à vin	335,456
L		plat à gâteau bois	154	rafraîchisseur de bouteilles	53,71,126,128, 256,443-444,446-447,449-452, 460,483	verre mélangeur	480
lampe de table	336-341,436-441	plat à gâteau mélamine	153,240	rafraîchisseur de caviar	149	verres gourmet	277
louche	514,516,518,519,521	plat à sauter	258-261	ramasse-miettes	315,505	verseurs continus	481
louche de service	517	plat ardoise naturelle	16,30-31,63,149, 156-161,165-166, 284,288-289,304	ramequin	47,205,243-246,257,270-271	vitrine de buffet	32-34,41
M		plateau	19,24,25,30,45,49,52,54,55, 60-66, 68,70,96,138-147,143-145, 148,149,151,152,158,161,163,174,176, 178,180, 182,185,188,189,190,191, 192,197,198,199,200,207,210,214,216, 217,218,219,220,221,224,225,227,230, 232,233,235,237,238,241,247,256,282, 283,286,289,290,292,316,329,361,423, 425,492,500-505	ramasse-miettes	315,505	vitrine de buffet acier inox	32-34
mandoline	541	plateau acier inox	24,25,138-147,149, 247,256,292,316, 500,501,502,505	range couverts	23,89-91,350-355, 362,367,381,428-430	W	
marmite	401	plateau bois	24,45,65,68,96,148,163,282, 283,286,290,329,492	réceptif à pâte	432,554	Weck-bouteilles	274-278,289
marmite avec couvercle	409-410,81-82	plateau feuille mélamine	203,222,239,248	réceptif de table	89-91,350-355,432,473		
marmite petite de servir	260,261,149	plateau mélamine	25,30,65,68, 70,145,151,158,174,176,178,180,182,185, 188,189,190,191,192,197,198,199,200, 207,210,216,217,218,219,220,221,224,22, 5,227,230,232,233,235,237,238, 241,247,289,500,502,503	repose-cuillère	431		
marqueur à la craie liquide	17,28,344, 346,386	plateau party	150	réceptif bain-marie	541		
mesure jigger	468-469	plateau self-service et snacks	152,504	réceptif à pâte et boules à pizza	432,554		
Moscow Mule gobelet	460-462	plateau sous-verre acier inox	316	résistance	18,85,129,398-399,403,404,413		
moule à boule ronde simple	530	plateau sous-verre mélamine	112	S			
moule à glaçons	478	plateau sushi mélamine	180,182,207	samovar	134,412,485		
moule à glaçons en boules	478	plateaux réfrigérés	24,31,36	saucière	314,315		
moule à pizza	552-553	plucheur droitier/gaucher	531,532	saupoudreuse à épices	310		
moules à flan	545	pochette à serviettes	325,326	seau	263,433,476-477,543		
moulin à poivre	301-310	pochette couverts	325,326	seau à champagne	127,442-444, 446-447, 448,449		
moulin à sel	301-310	podium	17,18,123	seau à glaçons	26,476		
multibox	133	poêle en fonte	268	seau à glaçons isothermique	443,476-477		
N		pompe de dosage	550	seau à vin	127,442-444,448-449		
organisateur bar caddy	474	pont thermique	51,53,406	service à fondue	317,407		
P		porcelaine	84,136-137,332-333, 394,397,402,494-495	service à parmesan	300-301		
pailles	475	porte verres à bière	151,503	service à punch	317,407		
panier à œufs	361	porte-addition	316,505	set apéritif	294-302,308		
panier en corde au crochet	372	porte-bols	106	set de service	183		
panier pour le service sur table	262	porte-bougies anti-vent	342	set de table	318-328		
panneau d'avertissement	550,575	porte-bouteille à vin	453	set rolltop	16,149		
papier alimentaire	169,143,159, 264,282,292,500	porte-cartes	343-349	set thermo	37		
pare-haleine	17,42,43,62	porte-cartes de table	343-349	shaker	463,466,467		
passoire	538-540	porte-clés avec câble à enroulement	483	snackbox	269,282		
peleur	531	porte-câbles	86-88	sonnette	505		
pelle	287,477,547,553,556,557	pose-cuillère	250,431	soucoupes ardoise naturelle	159,289,304		
pelle à farine	547			soucoupes liège	114-115		
pelle à gâteau	515,517			sous-tasse	112,136-137,332-333,594-595		
pelle à glaçons	477			spatule	516,519-520,534-535		
pelle à pizza	553			spatule à pâte	545		
petits chevalets de buffet	113,117,344-349			spatule coudée spéciale grill	536		
pichet	117,122-125,129-134,263, 122, 124-126,412,453,485-489,492			spatule pâtissière	169		
pichet à café	489			station de panure	18,85,403		
pichet à eau	122-125			station de charge	340-341,440-441		
pichet à jus de fruit	122-125,247			station de panure	551		
				station pain	68		
				stylo	346		
				sucrier	330-331,491-492		
				superbox	28-30,386-387		





Buffet & Display

VALO	14
BRIDGE	20
FRAMES	24
SUPERBOX	28
COOLING DISPLAYS	31
BUFFET GUARDS	42
FRIENDLY	46
FROSTFIRE	50
BUFFET DISPLAY	56
ETAGERES	60
CUTTING BOARDS	68
MULTI RACKS	75
JARS	76
SPHERE	79
5 STARS	80
NAPKIN HOLDERS	86
CUTLERY BOXES	89
BUFFET STANDS	92
MANGO	96
CEREAL DISPENSERS	100
BEVERAGE DISPENSERS	110
CARAFES	122
BEVERAGE BOWLS	126
VACUUM JUGS	130
TEAPOTS	132
TRAYS STAINLESS STEEL	138
FAST FOOD TRAYS	152
CAKE STANDS	153
SUPER DOME	155
SERVING BOARDS NATURAL SLATE	156
SERVING BOARDS WOOD	162

NEW VALO



Auf Gastronom-Größen basierende, stapelbare Boxen und Tablett bilden das Herzstück des innovativen und erweiterbaren Buffetsystems, das zahlreiche Kombinationsmöglichkeiten nicht nur innerhalb des VALO Sortiments zulässt, sondern auch mit vielen weiteren APS Produkten. Geeignet für die vielseitige Speisenpräsentation ist VALO somit ein universelles System, das mit seinem umfangreichen und multifunktionalen Zubehörsortiment Lösungen für alle Anforderungen bietet.

Stackable boxes and trays based on the gastronorm sizes form the centrepiece of the innovative and expandable buffet system, which allows numerous possible combinations not only within the VALO range, but also with many other APS products. Suitable for versatile food presentation, VALO is thus a universal system that offers solutions for all requirements with its extensive and multifunctional range of accessories.

Las cajas y bandejas apilables basadas en tamaños gastronorm forman el núcleo del innovador y ampliable sistema de buffet, que permite numerosas posibilidades de combinación no sólo dentro de la gama VALO, sino también con muchos otros productos APS. Adecuado para la presentación versátil de fiambresas, VALO es, por tanto, un sistema universal que ofrece soluciones para todos los requisitos gracias a su amplia y multifuncional gama de accesorios.

Des boîtes et des plateaux empilables, basés sur les dimensions gastronorm, constituent le cœur de ce système de buffet innovant et extensible, qui permet de nombreuses combinaisons non seulement au sein de la gamme VALO, mais aussi avec de nombreux autres produits APS. VALO est donc un système universel qui offre des solutions à toutes les exigences grâce à sa vaste gamme d'accessoires multifonctionnels.



Kombinierbar mit VALO Schieferplatten und vielen anderen Komponenten in Gastronom-Größen.

Puede combinarse con las bandejas de pizarra VALO y muchos otros componentes en tamaños Gastronom.

NEW



14000



14001



14002

GN 1/1 Holzbox

GN 1/1 woodbox
GN 1/1 caja madera
GN 1/1 base bois



Eichenholz (geölt) / oak wood (oiled) / madera de roble (aceitada) / chêne (huilé)

	cm	↑ cm	GN
14000	53 x 32,5	4,5	1/1
14001	53 x 32,5	8,5	1/1
14002	53 x 32,5	16,5	1/1

NEW



14003



14004



14005

GN 1/2 Holzbox

GN 1/2 woodbox
GN 1/2 caja madera
GN 1/2 base bois



Eichenholz (geölt) / oak wood (oiled) / madera de roble (aceitada) / chêne (huilé)

	cm	↑ cm	GN
14003	32,5 x 26,5	4,5	1/2
14004	32,5 x 26,5	8,5	1/2
14005	32,5 x 26,5	16,5	1/2

NEW



14006



14007

GN 1/3 Holzbox

GN 1/3 woodbox
GN 1/3 caja madera
GN 1/3 base bois



Eichenholz (geölt) / oak wood (oiled) / madera de roble (aceitada) / chêne (huilé)

	cm	↑ cm	GN
14006	32,5 x 17,5	4,5	1/3
14007	32,5 x 17,5	8,5	1/3

NEW



14008



14009

GN 2/4 Holzbox

GN 2/4 woodbox
GN 2/4 caja madera
GN 2/4 base bois



Eichenholz (geölt) / oak wood (oiled) / madera de roble (aceitada) / chêne (huilé)

	cm	↑ cm	GN
14008	53 x 16,2	4,5	2/4
14009	53 x 16,2	8,5	2/4



GN Naturschieferplatte

GN natural slate tray
GN bandeja de pizarra natural
GN plat ardoise naturelle



Schieferplatte mit möbelschonenden Füßchen

slate top with furniture-friendly feet
encimera de pizarra con patas aptas para muebles
plateau en ardoise avec pieds qui protègent les meubles

	cm	✦ mm	GN
1001	53 x 32,5	6 - 9	1/1
1002	53 x 16,2	6 - 9	2/4
1003	32,5 x 26,5	6 - 9	1/2
1004	32,5 x 17,6	6 - 9	1/3



Einsatz für GN 1/1 Holzbox

insert for GN 1/1 woodbox
separador para GN 1/1 caja madera
insert pour GN 1/1 base bois



Einsatz mit Fächern 9,5 x 9,5 cm

insert with compartments 9,5 x 9,5 cm
bandeja con compartimentos 9,5 x 9,5 cm
insert avec compartiments 9,5 x 9,5 cm

	cm	↑ cm	fits to
14021	50,5 x 30	6	14001



Einsatz für GN 1/2 Holzbox, 2er Set

insert for GN 1/2 woodbox, 2 pcs
separador para GN 1/2 caja madera, set de 2
insert pour GN 1/2 base bois, set de 2



Einsatz mit drei Fächern

insert with 3 compartments
bandeja con 3 compartimentos
insert avec 3 compartiments

	cm	↑ cm	fits to
14022	24 x 10,5	6	14004



GN Einsatz

GN insert
GN bandeja
GN bac supérieur



Einsatz passend zu Artikel 14002

insert suitable for article 14002
inserto adecuado para el artículo 14002
insert adapté à l'article 14002

	cm	↑ cm	fits to
14036	51,5 x 31	14	14002
14037	31 x 25	13	14005





NEW



14030



14031



14032



14033



14034



14035

GN Buffetständer

GN buffet stand + Zubehör

GN soporte para buffet

GN présentoir buffet



- Multifunktionaler stapelbarer Buffetständer aus pulverbeschichtetem Metall
- Stecktafel
- Eckverbindung
- Podest und Schild
- Hygieneschutz

- multifunctional stackable buffet stand made of powder-coated metal
- pegboard
- corner connection
- pedestal and shield
- hygienic protection

- soporte multifuncional apilable para bufé fabricado en metal con recubrimiento en polvo
- tablero de anuncios
- conexión de esquina
- pedestal y escudo
- protección higiénica

- support de buffet multifonctionnel empilable en métal revêtu par poudre
- panneau d'affichage
- raccord d'angle
- plateforme et bouclier
- protection hygiénique

	cm	↑ cm
14030	57 x 37	28,5
14031	57 x 1	19,5
14032	39 x 39	3
14033	∅ 25	20,5
14034	∅ 25	33
14035	60,5 x 36,5	33,5

Kreide-Marker, Stärke 2 mm, 2er Set

chalk marker, 2 pcs.

rotulador de tiza, set de 2

marqueur a la craie liquide, set de 2



	∅ cm	↑ cm	Farbe / Colour	pcs.
71490	1	13		2





Getränkespender

beverage dispenser
dispensador de bebidas
distributeur de boissons



Eichenholz (wasserfest lackiert), Zapfhahn aus Edelstahl, Untersetzer aus Melamin, Bodenplatte (Gläserntablett) herausnehmbar

oak wood (waterproof lacquered), Stainless steel tap, melamine coaster, removeable base plate
madera de roble (lacado impermeable), grifo de acero inoxidable, posavasos de melamina, placa base desmontable
bois de chêne (vernis imperméable), binet en acier inoxydable, dessous de verre en mélamine, plaque de fond amovible

	cm	↑ cm	ltr.
14015	21 x 21	46,5	7
14016	43,5 x 21	46,5	2 x 7

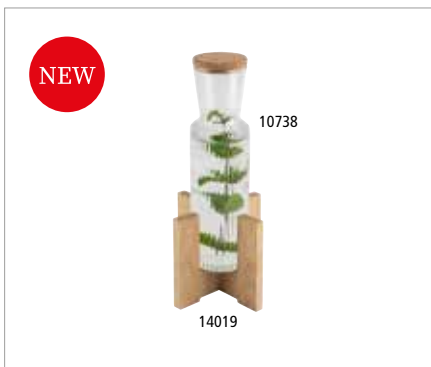

Podest für Glaskaraffe

podest for glass carafe
pedestal para jarra de vidrio
podium pour pichet en verre



Eichenholz (wasserfest lackiert)
oak wood (waterproof lacquered)
madera de roble (lacado impermeable)
bois de chêne (vernis imperméable)

	cm	↑ cm	fits to
14019	15 x 15	12	10738, 10739



Antirutschmatte

anti-slip mat
alfombrilla antideslizante
tapis antidérapant



Passend für GN 1/1, GN 1/2, GN 2/4
suitable for GN 1/1, GN 1/2, GN 2/4
decuado para GN 1/1, GN 1/2, GN 2/4
convient pour GN 1/1, GN 1/2, GN 2/4

	fits to
14038	GN 1/1
14039	GN 1/2
14040	GN 2/4



Induktionsstation, 2-tlg. Set

Induction station, 2-piece set
Estación de inducción, juego de 2 piezas
Station à induction, set de 2 pièces



Set, bestehend aus Induktionkochplatte 2000 Watt (no. 12285), inklusive Kabel-Fernbedienung, Leistung in Stufen regelbar, Rahmen aus Eichenholz (wasserfest lackiert) (no. 14051)
set consists of induction hotplate 2000 Watt, cable remote control, power adjustable in steps, frame made of oak (waterproof lacquered)

set, compuesto por placa de inducción 2000 Watt (no. 12285), incluye mando a distancia por cable, potencia regulable en pasos, madera de roble (lacado impermeable)
set, composé d'une plaque de cuisson à induction 2000 watts (no. 12285), télécommande filaire incluse, puissance réglable par paliers, bois de chêne (vernis imperméable)

	cm	↑ cm	
14050	39 x 39	10	2000 W

NEW



14010



14011

Etagère, 2-stufig

2-tier tray
bandeja 2 alturas
étagère carré 2 hauteurs

Gestell aus Eichenholz (geölt)

oak wood frame (oiled)
marco de madera de roble (aceitada)
structure en bois du chêne (huilé)



	cm	↑ cm	fits to
14010	35 x 26,5	44,5	GN 1/2, 1/3
14011	55,5 x 26,5	44,5	GN 2/4

NEW



14012

Etagère, 3-stufig

3-tier tray
bandeja 3 alturas
étagère carré 3 hauteurs

Gestell aus Eichenholz (geölt)

oak wood frame (oiled)
marco de madera de roble (aceitada)
structure en bois du chêne (huilé)



	cm	↑ cm	fits to
14012	55,5 x 32,5	64	GN 1/1, 2/4

NEW



14013



14014

Etagère, 2+3-stufig, rund

2+3-tier tray, round
bandeja 2+3 alturas, en torno a
étagère carré 2+3 hauteurs, rond

Gestell aus Eichenholz (geölt)

oak wood frame (oiled)
marco de madera de roble (aceitada)
structure en bois du chêne (huilé)



	Ø cm	↑ cm
14013	30	28
14014	30	42



BRIDGE

Mit hohem Anspruch an Design und Funktionalität haben wir das Buffet-System „Bridge“ für Sie entwickelt. Die in den Holzoberflächen Ahorn und Wenge erhältlichen Artikel sind in ihren Höhen und ihren Volumina optimal aufeinander abgestimmt und gewährleisten einen einfachen und sicheren Umgang in Ihrem Gastronomiealltag.

The collection "Bridge" is bringing perfectly coordinated components for an uncomplicated and organized buffet system, finalizing in a unique buffet scenery. All pieces combine perfectly with one another in their variations of sizes and volumes. The wooden items are available in 2 colors, maple or wenge. A simple and safe handling is guaranteed.

Una colección universal para un buffet único: un Sistema funcional y fácil de componer, asociado a la elegancia de su exclusivo diseño. Los elementos se combinan a la perfección entre variaciones de Alturas y volúmenes, realizando sus propuestas y composiciones culinarias y modelando el paisaje del buffet. Las piezas están disponibles en 2 colores, wengué o arce. Manejo sencillo y seguro.

Une collection universelle pour une présentation unique de votre buffet: fonctionnel et facile à composer, ce système est à la fois pratique, simple et spectaculaire par son élégant design. Les différents éléments se marient à la perfection pour construire sans difficulté différentes compositions, variant les hauteurs et les volumes et mettant en valeur vos créations culinaires. Les pièces sont disponibles en deux couleurs, bois wengé ou érable.



Kühlbox „BRIDGE“ refrigerated buffet display set de buffet refrigerado présentoir buffet froid



Set bestehend aus: 1 Gestell aus Ahorn oder Wenge, 1 Behälter aus Kunststoff, 1 GN1/1 Tablett aus Melamin, 1 Kühllakku, 1 Rolltophaube (fix montiert)

set consists of: 1 base element maple or wenge, 1 plastic insert black, 1 GN1/1 tray melamine, 1 cooler, 1 cover (fixed)

set compuesto por: 1 soporte de madera arce o wengué, 1 cubeta de plástico, 1 bandeja de melamina GN 1/1, 1 acumulador de frío, 1 campana rolltop (fija)

set composé de: 1 support en bois érable ou wengé, 1 bac plastique, 1 plat en mélamine GN 1/1, 1 accumulateur de froid, 1 cloche rolltop (fixe)

	cm	↑ cm	Farbe / Colour	
13990	63,5 x 42,5	31		ahorn wood
14990	63,5 x 42,5	31		wenge wood

**Kühlschale „BRIDGE“**

cooling bowl
bol refrigerado
bol réfrigéré



4-teilig: 1 Gestell aus Ahorn oder Wenge, 1 Behälter aus Edelstahl,
1 Schale aus Melamin (Ø 14 cm o. 23 cm), 1 Kühlakku

4 pcs.: 1 base element maple or wenge, 1 bowl stainless steel,
1 bowl melamine (Ø 14 or 23 cm), 1 cooler

set de 4: 1 soporte de madera arce o wengué, 1 cuenco
de acero inoxidable, 1 cuenco de melamina (ø 14 cm o 23 cm), 1 acumulador de frío

set de 4: 1 support en bois érable ou wengé, 1 bol en acier inox, 1 bol en mélamine
(ø 14 cm ou 23 cm), 1 accumulateur de froid

	cm	↑ cm	ltr.	Farbe / Colour
13980	18,5 x 18,5	10	0,5	—
13981	27,5 x 27,5	14	2,5	—

	cm	↑ cm	ltr.	Farbe / Colour
14980	18,5 x 18,5	10	0,5	—
14981	27,5 x 27,5	14	2,5	—

**Edelstahlschale „BRIDGE“**

stainless steel bowl
cuenco acero inoxidable
bol acier inox



	Ø cm	↑ cm
30050	14	8,5
30052	23	13,5

**Schale „CASUAL MAXI“**

bowl
cuenco
bol



	Ø cm	↑ cm	ltr.	Farbe / Colour
83700	14	6,5	0,5	—
83702	23	10,5	2,5	—

	Ø cm	↑ cm	ltr.	Farbe / Colour
83701	14	6,5	0,5	—
83703	23	10,5	2,5	—

**Kühlakku**

cooler
acumulador de frío
accumulateur de froid



	Ø cm	↑ cm
10661	10,5	2,0
10777	15,0	2,5



Milchdispenser „BRIDGE“

milk dispenser
dispensador de leche
distributeur à lait



Edelstahl Dispenser mit 1 Kühlakku im Standfuß inklusive touchless adapter

stainless steel dispenser with 1 cooling element in stand including touchless adapter
dispensador de acero inoxidable con 1 acumulador de frío en la base y con adaptador sin contacto para grifo
distributeur en acier inox avec 1 accumulateur de froid dans le socle et avec adaptateur sans contact manuel

	cm	↑ cm	ltr.	Farbe / Colour
10836	31 x 20	39	3	Ahorn / maple
10838	39 x 22	45	5	Ahorn / maple



Milchdispenser „BRIDGE“

milk dispenser
dispensador de leche
distributeur à lait



Edelstahl Dispenser mit 1 Kühlakku im Standfuß inklusive touchless adapter

stainless steel dispenser with 1 cooling element in stand including touchless adapter
dispensador de acero inoxidable con 1 acumulador de frío en la base y con adaptador sin contacto para grifo
distributeur en acier inox avec 1 accumulateur de froid dans le socle et avec adaptateur sans contact manuel

	cm	↑ cm	ltr.	Farbe / Colour
10837	31 x 20	39	3	Buche / beech
10839	39 x 22	45	5	Buche / beech



Saftdispenser „BRIDGE“

juice dispenser
dispensador de zumo
distributeur à jus



Kühlung durch 2 Kühlakkus von oben und unten

cooling with 2 cooling elements from the top and base
2 acumuladores de frío: 1 en la base y 1 en la tapa
2 accumulateurs de froid: 1 dans le couvercle et 1 dans le socle

	cm	↑ cm	ltr.	Farbe / Colour
10870	31,0 x 20	42	4	Ahorn / maple
10871	35,5 x 22	50	6	Ahorn / maple



inklusive 3 Magnetschilder: ORANGE, APPLE, GRAPEFRUIT
including 3 magnetic signs: ORANGE, APPLE, GRAPEFRUIT



Saftdispenser „BRIDGE“

juice dispenser
dispensador de zumo
distributeur à jus



Kühlung durch 2 Kühlakkus von oben und unten

cooling with 2 cooling elements from the top and base
2 acumuladores de frío: 1 en la base y 1 en la tapa
2 accumulateurs de froid: 1 dans le couvercle et 1 dans le socle

	cm	↑ cm	ltr.	Farbe / Colour
10872	31,0 x 20	42	4	Wenge / wenge
10873	35,5 x 22	50	6	Wenge / wenge



inklusive 3 Magnetschilder: ORANGE, APPLE, GRAPEFRUIT
including 3 magnetic signs: ORANGE, APPLE, GRAPEFRUIT



4,5 ltr.

Cerealienspender „BRIDGE“

cereal dispenser
dispensador de cereales
distributeur de céréales



Behälter herausnehmbar, „Feierabend-Deckel“ für das aromadichte Lagern, Portionieren durch einfaches Drehen

removable canister, special lid to keep the cereals fresh, easy to use, rotate the button to get the muesli

contenedor extraíble, tapa especial para mantener los cereales frescos, fácil de usar, se gira el pomo para servir los cereales

réceptif amovible, couvercle spécial pour conserver les céréales, usage facile en tournant le bouton

	cm	↑ cm	ltr.	Farbe / Colour	
13987	21 x 20	55,5	4,5		Ahorn / maple



4,5 ltr.

Cerealienspender „BRIDGE“

cereal dispenser
dispensador de cereales
distributeur de céréales



Behälter herausnehmbar, „Feierabend-Deckel“ für das aromadichte Lagern, Portionieren durch einfaches Drehen

removable canister, special lid to keep the cereals fresh, easy to use, rotate the button to get the muesli

contenedor movible, tapa especial para mantener los cereales frescos, fácil de usar, se gira el pomo para servir los cereales

réceptif amovible, couvercle spécial pour conserver les céréales, usage facile en tournant le bouton

	cm	↑ cm	ltr.	Farbe / Colour	
14987	21 x 20	55,5	4,5		Buche / beech

**Besteckbehälter „BRIDGE“**

cutlery organizer
cajón para cubiertos
bac à couverts



2 teiliges Set: 1 Gestell, 1 Besteckbehälter (Nr. 11955), herausnehmbar

2 pcs.: 1 base element, 1 removable plastic container (item 11955)

set de 2: 1 soporte, 1 cajón para cubiertos (ref. 11955) extraíble

set de 2: 1 support, 1 bac à couverts (réf. 11955) amovible

	cm	↑ cm	Farbe / Colour	
13995	57,5 x 37	12		Ahorn / maple

**Besteckbehälter „BRIDGE“**

cutlery organizer
cajón para cubiertos
bac à couverts



2 teiliges Set: 1 Gestell, 1 Besteckbehälter (Nr. 11955), herausnehmbar

2 pcs.: 1 base element, 1 removable plastic container (item 11955)

set de 2: 1 soporte, 1 cajón para cubiertos (ref. 11955) extraíble

set de 2: 1 support, 1 bac à couverts (réf. 11955) amovible

	cm	↑ cm	Farbe / Colour	
14995	57,7 x 37	12		Buche / beech

FRAMES



Die reduzierte, archetypische Formsprache von FRAMES nimmt sich elegant zurück und lässt damit viel Raum für die Inszenierung der Buffet-Speisen. Ein scheinbarer Widerspruch löst sich auf: das Design ist zeitgemäß und zeitlos zugleich.

Design in detail – The classic minimalist visual style of FRAMES is elegantly understated, leaving plenty of potential for creating appealing buffet arrangements. Its design transcends what at first seems to be an irreconcilable paradox, being at once both timeless and highly contemporary.

Diseño en detalle - El estilo visual clásico y minimalista de FRAMES es elegantemente sobrio, dejando mucho potencial para crear atractivas composiciones para el buffet. Su diseño supera lo que a primera vista parece una paradoja irreconciliable, siendo a la vez intemporal y muy contemporáneo.

Le design dans le détail - Le style visuel minimaliste classique de FRAMES est élégamment discret, laissant beaucoup de potentiel pour créer des arrangements de buffet attrayants. Son design transcende ce qui semble à première vue être un paradoxe irréconciliable, étant à la fois intemporel et très contemporain.



Kühltablets SET 1 „FRAMES“

cooling plates
bandejas refrigeradas
plateaux réfrigérés



GN 1/1 Basiselement, GN 1/1 Edeltahl Tablett 18/10, Kühlakku
GN 1/1 base element, GN 1/1 stainless steel platter 18/10, cooler
élément de base GN 1/1, plateau GN 1/1 en acier inox 18/10, accumulateur de froid

	cm	↑ cm	GN	Farbe / Colour	
12940	53 x 32,5	8,5	1/1	■	stainless steel
14940	53 x 32,5	8,5	1/1	■	wenge wood



Kühltablets SET 2 „FRAMES“

cooling plates
bandejas refrigeradas
plateaux réfrigérés



GN 1/1 Basiselement, GN 1/1 Edeltahl Tablett 18/10, Rolltophaube, Kühlakku
GN 1/1 base element, GN 1/1 stainless steel platter, rolltop cover, cooler
elemento básico GN 1/1, bandeja GN 1/1 de acero inoxidable 18/10, campana rolltop, acumulador de frío
élément de base GN 1/1, plateau GN 1/1 en acier inox 18/10, cloche rolltop, accumulateur de froid

	cm	↑ cm	GN	Farbe / Colour	
12941	53 x 32,5	27,5	1/1	■	stainless steel
14941	53 x 32,5	27,5	1/1	■	wenge wood



Schneidebrett „FRAMES“

cutting board
tabla de cortar
planche à découper



	cm	↑ cm	GN
17910	53 x 32,5	2,5	1/1



82355
GN 1/1

GN Tablett „FRAMES“

GN tray
GN bandeja
GN plateau



	cm	↑ cm	GN
82355	53,0 x 32,5	2	1/1
82356	32,5 x 26,5	2	1/2
82357	32,5 x 17,6	2	1/3



GN Edelstahl Tablett „FRAMES“

GN stainless steel platter
GN bandeja acero inoxidable
GN plateau acier inox



	cm	↑ cm	GN
11119	53,0 x 32,5	2	1/1



84046

GN Tablett „FRAMES“

GN tray
GN bandeja
GN plateau



	cm	↑ cm	GN
84046	53,0 x 32,5	2	1/1
84047	32,5 x 26,5	2	1/2
84048	32,5 x 17,6	2	1/3



GN Wanne „FRAMES“

GN tray
GN bandeja
GN plateau



	cm	↑ cm	GN
17922	53 x 32,5	8	1/1

FRAMES



Korb „GN LINE“

GN basket

GN cesta

GN corbeille



stabile Ausführung mit Edelstahldraht im Rand zur Stabilisierung

very solid with stainless steel wire frame to stabilize the basket

muy resistente con alambre de acero inoxidable en el borde para la estabilización

très résistante avec fil d'acier inox dans le bord pour la stabilisation

	cm	↑ cm	GN
40291	53,0 x 32,5	6,5	1/1
40290	32,5 x 26,5	6,5	1/2
40293	53,0 x 32,5	10,0	1/1
40292	32,5 x 26,5	10,0	1/2



Buffetkorb „ECONOMIC“

basket

cesta

corbeille

Polyrattan, mit Haubenschiene (ohne Haube)

polyrattan, with frame to fix the cover (without cover)

polyrattan, con fijación para campana (sin campana)

polyrattan, avec fixation pour la cloche (sans cloche)



	cm	↑ cm
40294	56,5 x 36,0	10



Buffetkorb „ECONOMIC“

buffet basket

cesta de buffet

corbeille de buffet

Polyrattan, mit Haubenschiene (ohne Haube)

polyrattan, with frame to fix the cover (without cover)

polyrattan, con fijación para campana (sin campana)

polyrattan, avec fixation pour la cloche (sans cloche)



	Ø cm	↑ cm
40295	40	12,5



Rolltophaube

rolltop cover

campana abatible

cloche basculante



	Ø cm	↑ cm
18389	38	20



Eisbox „FRAMES“

ice box

bandeja para hielo

caisse à glaçons

3-teilig: 1 Basiselement Wenge + 1 Polystyrolwanne + 1 Tropfgitter

3 pcs. set: 1 box wenge + 1 plastic deep tray + 1 drainer plate

set de 3: 1 cajón color wengué + 1 cubeta plástico + 1 rejilla

set de 3: 1 caisson couleur wengé + 1 bac plastique + 1 plaque perforée



	cm	↑ cm	GN	Farbe / Colour
14970	53 x 32,5	12,5	1/1	■



vielseitig einsetzbar für alle GN 1/1 Artikel

Gestell für GN 1/1 „FRAMES“

serving stand GN 1/1
soporte para GN 1/1
support pour GN 1/1

Buche massiv, Wenge
solid beech, colour wenge
haya maciza, color wengué
hêtre massif, couleur wengé



	cm	↑ cm	Farbe / Colour
14953	57,5 x 27,5	22	



passendes Kühltablett Set



passende Besteck / Universal-Box GN 1/1



Einsatz / insert

Besteck- / Universal-Box, 2-teilig „FRAMES“

cutlery tray, 2 pcs.
cubertero o cajón multi-usos, set de 2
caisson à couverts ou multi-usages, set de 2

Buche massiv, Wenge, 4 Fächer, inklusive herausnehmbaren Einsatz
solid beech, colour wenge, 4 compartments, including removable insert
haya maciza, color wengué, 4 compartimentos, con separador extraíble
hêtre massif, couleur wengé, 4 compartiments, avec insert amovible



	cm	↑ cm	GN	Farbe / Colour
14956	53 x 32,5	11	1/1	

Einsatz für GN 1/1 „FRAMES“ / insert for GN1/1 / separador para GN1/1 / insert pour GN1/1

	cm	↑ cm	Farbe / Colour
14954	48,5 x 28	8	



GN 1/1 Rolltophaube

GN 1/1 rolltop cover
GN 1/1 campana abatible
GN 1/1 cloche basculante

verchromter Zinkdruckguss-Griff
chrome plated metal handle
mango cromado de fundición a presión de zinc
poignée en zinc moulé sous pression chromé



	cm	↑ cm	GN
11018	53 x 32,5	17	1/1



GN 1/1 Rolltophaube

GN 1/1 rolltop cover
GN 1/1 campana abatible
GN 1/1 cloche basculante

patentiert, passend für GN-Behälter, -Tablets, etc., leichtgängig auf- und zuklappbar 90°
patented, suitable for GN containers, trays, etc., solid quality, 90° opening
patentada, para contenedores, bandejas GN, apertura 90°
brevetée, pour bacs, plateaux GN, ouverture 90°



	cm	↑ cm	GN
11008	53 x 32,5	17	1/1



SUPERBOX

00973
Schieferplatte
GN 2/4

11620
Box GN 1/1

11621
Box GN 1/2

Die stapelbaren Wendeboxen lassen sich rutschfest stapeln und mit flachen GN Platten verbinden und einzeln nutzen. Individuell können Buffet-landschaften gebaut werden.

The stackable and non-slip reversible boxes can be connected to flat GN trays and can also be used individually. Different and individual buffet sceneries can be built up.

Las cajas girables y apilables son antideslizantes y se pueden conectar con bandejas planas GN o utilizar individualmente. Se pueden construir diferentes paisajes de buffet muy individuales.

Les boîtes de tournage empilables sont antiglissantes et peuvent être connectées avec des plateaux plats GN ou utilisées individuellement. Des paysages de buffet très personnalisés peuvent être construits.



NEW

2 tlg.
2 pcs.

11719

Beschriftungsschilder, 2er Set
inscription labels, 2 pcs.
étiquettes d'inscription, set de 2
etiquetas de inscripción, set de 2



	cm	↑ cm	Farbe / Colour
11719	8 x 1,5	5,5	■



Kreide-Marker, Stärke 2 mm, 2er Set
chalk marker, 2 pcs.
rotulador de tiza, set de 2
marqueur a la craie liquide, set de 2



	Ø cm	↑ cm	Farbe / Colour	pcs.
71490	1	13	■	2



11626

11721

GN 1/1 „SUPERBOX“



Akazienholz / acacia wood / madera de acacia / bois d'acacia

	cm	↑ cm	GN	Farbe / Colour
11620	55,5 x 35,0	10,5	1/1	■
11626	55,5 x 35,0	10,5	1/1	■
11721	55,5 x 35,0	20,0	1/1	■
11723	55,5 x 35,0	20,0	1/1	■



GN 2/4 „SUPERBOX“



Akazienholz / acacia wood / mader de acacia / bois d'acacia

	cm	↑ cm	Farbe / Colour
11623	55,5 x 18,5	10,5	
11629	55,5 x 18,5	10,5	



GN 1/2 „SUPERBOX“

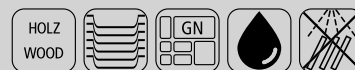

Akazienholz / acacia wood / mader de acacia / bois d'acacia

	cm	↑ cm	GN	Farbe / Colour
11621	35,0 x 29,0	10,5	1/2	
11627	35,0 x 29,0	10,5	1/2	
11722	35,0 x 29,0	20,0	1/2	
11724	35,0 x 29,0	20,0	1/2	



GN 1/4 „SUPERBOX“



Akazienholz / acacia wood / mader de acacia / bois d'acacia

	cm	↑ cm	Farbe / Colour
11622	29 x 18,5	10,5	
11628	29 x 18,5	10,5	



Buffetgestell

buffet stand
soporte para buffet
présentoir buffet



Metall, schwarz, passend für GN Boxen, mit Antrutschfüßchen

metal, black, suitable for GN boxes, with non-slip feet

metal, negro, para cajas GN, con pies antideslizantes

métal, noir, pour boîtes GN, avec pieds antidérapantsw

	cm	↑ cm	suitable for	Farbe / Colour
30329 <small>NEW</small>	29 x 32,5	48	GN 1/2 boxes	
30331	49 x 38,5	48	GN 1/1, GN 1/2 boxes	



Präsentationsmöglichkeit
presentation example



GN Tablett „ZERO“

GN tray
GN bandeja
GN plateau



	cm	↑ cm	GN	Farbe / Colour
84185	53,0 x 32,5	1,5	1/1	_____
84186	32,5 x 26,5	1,5	1/2	_____
84188	26,5 x 16,2	1,5	1/4	_____
84189	53,0 x 16,2	1,5	2/4	_____



mit Antirutschfüßchen
with non-slip feet

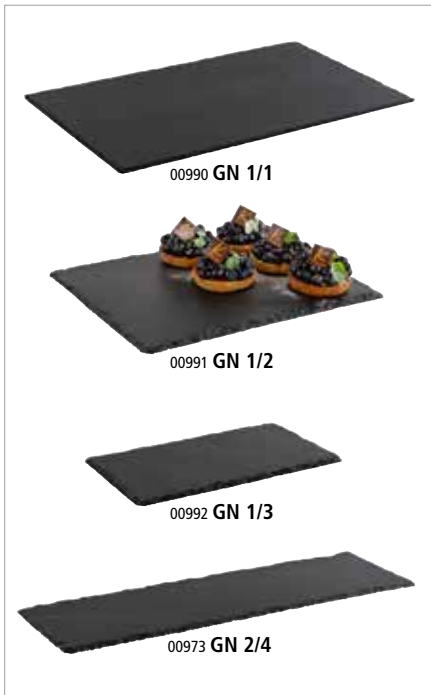

GN Naturschieferplatten

GN natural slate tray
GN bandeja de pizarra natural
GN plat ardoise naturelle



	cm	✱ mm	GN
00990	53,0 x 32,5	6 - 9	1/1
00991	32,5 x 26,5	6 - 9	1/2
00993	26,5 x 16,2	6 - 9	1/4
00973	53,0 x 16,2	6 - 9	2/4



GN Einsatz „SUPERBOX“

GN insert
GN bandeja
GN bac supérieur



	cm	↑ cm	GN	fits to
11616	53,0 x 32,5	8,5	1/1	11620, 11626
11617	32,5 x 26,5	8,5	1/2	11621, 11627





3 tlg.
3 pcs.

Kühlbox „SLATE“
refrigerated buffet display
expositor buffet frío
plateau buffet froid

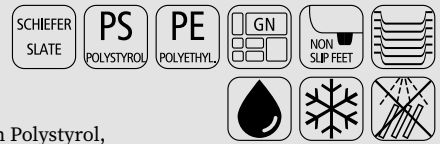

3-teilig, bestehend aus: 1 Basis aus schwarzem Polystyrol,
1 Naturschieferplatte, 1 Kühlakku (ohne Haube)

3 pcs., set consists of: 1 base made of black polystyrene, 1 natural slate tray, 1 cooler (without cover)

set de 3 compuesto por: 1 soporte de poliestireno negro, 1 bandeja de pizarra natural, 1 acumulador de frío (sin campana)

set de 3 composé de: 1 support en polystyrène noir, 1 plateau en ardoise naturelle, 1 accumulateur de froid (sans couvercle)

	cm	↑ cm
11645	58 x 38	6,5

Naturschieferplatte / natural slate tray / bandeja de pizarra natural / plateau ardoise naturelle

	cm	✱ mm
00979	58 x 38	6 - 9

Kühlakku / cooler / acumulador de frío / accumulateur de froid

	cm	↑ cm
10782	41 x 21	2,5

GN Rolltophaube mit schwarzem Griff / GN rolltop cover with black handle / GN campana rolltop con mango negro / GN cloche rolltop avec poignée noire

	cm	↑ cm	GN
11075	53 x 32,5	19	1/1



4 tlg.
4 pcs.

Kühlbox „TOP FRESH GN 1/1“
cooling plate
bandeja de frío
présentoir buffet réfrigéré



4-teilig: 1 Kühlbox + 1 Tablett GN 1/1 + 2 Kühlakkus, ohne Haube

4 pcs.: 1 box + 1 tray GN 1/1 + 2 coolers, without cover

set de 4: 1 caja + 1 bandeja GN 1/1 + 2 acumuladores de frío, sin campana

set de 4: 1 caisson + 1 plateau GN 1/1 + 2 accumulateurs de froid, sans cloche

	cm	↑ cm	Farbe / Colour
11503	56,5 x 35	6,5	White
11505	56,5 x 35	6,5	Black

GN Rolltophaube mit vergoldetem Kreuzgriff / GN rolltop cover with gold-plated cross handle / GN campana rolltop con asa en cruz dorada / GN cloche rolltop avec manche en croix plaqué or

	cm	↑ cm	GN
11008	53,0 x 32,5	19	1/1 mit vergoldetem Kreuzgriff

GN Rolltophaube mit verchromtem Kreuzgriff / GN rolltop cover with chrome-plated cross handle / GN campana rolltop con asa en cruz cromada / GN cloche rolltop avec manche en croix chromée

	cm	↑ cm	GN
11010	53 x 32,5	19	1/1 mit verchromtem Kreuzgriff

Kühlakku / cooler / acumulador de frío / accumulateur de froid

	cm	↑ cm
10791	25 x 19	2,5

GN Edelstahl-Tablett „PROFI LINE“ / GN tray / GN bandeja / GN plateau

	cm	↑ cm	GN
11100	53 x 32,5	1,5	1/1

Kühlakkus halten Ihre Speisen bis zu 6 Stunden kühl
cooling system keeps the food cool for up to 6 hours

COOLING DISPLAYS

4 tlg.
4 pcs.



11546



11075

Buche, wasserfest lackiert
beech wood lacquered



10791

Kühlakku halten Ihre Speisen bis zu 6 Stunden kühl
cooling system keeps the food cool for up to 6 hours

Buffetvitrine „TOP FRESH GN 1/1“ refrigerated buffet display expositor buffet frío plateau buffet froid



4-teilig: 1 Box aus Buchenholz mit Kunststoffwanne + 1 Edelstahl-Tablett GN 1/1 + 2 Kühlakku, ohne Haube

4 pcs.: 1 beech wood box with plastic insert + 1 stainless steel tray GN 1/1 + 2 coolers, without cover

set de 4: 1 caja de madera de haya con bandeja de plástico + 1 bandeja de acero inoxidable GN 1/1 + 2 acumuladores de frío, sin campana

set de 4: 1 boîte en bois de hêtre avec bac en plastique + 1 plateau en acier inox GN 1/1 + 2 accumulateurs de froid, sans cloche

	cm	↑ cm
11546	60 x 41	5

GN Rolltophaube mit schwarzem Griff / GN rolltop cover with black handle / GN campana rolltop con mango negro / GN cloche rolltop avec poignée noir

	cm	↑ cm	GN
11075	53 x 32,5	19	1/1

GN Rolltophaube mit Chromgriff / GN rolltop cover with chrome handle / GN campana rolltop con asa cromada / GN cloche rolltop avec poignée chromée

	cm	↑ cm	GN
11010	53 x 32,5	19	1/1

Kühlakku / cooler / acumulador de frío / accumulateur de froid

	cm	↑ cm
10791	25 x 19	2,5

12 tlg.
12 pcs.



11547

Buche, wasserfest lackiert
beech wood lacquered



10791

Kühlakku halten Ihre Speisen bis zu 6 Stunden kühl
cooling system keeps the food cool for up to 6 hours

Buffetvitrine „DOPPELDECKER GN 1/1“ refrigerated buffet display expositor buffet frío plateau buffet froid



12-teilig: 2 Boxen aus Buchenholz mit Kunststoffwanne + 2 Edelstahl-Tablets GN 1/1 + 4 Kühlakku + 4 verchromte Stangen, ohne Hauben

12 pcs.: 2 beech wood boxes with plastic insert + 2 stainless steel trays GN 1/1 + 4 coolers + 4 chrome-plated bars, without covers

set de 12: 2 cajas de madera de haya con bandeja de plástico + 2 bandejas de acero inoxidable GN 1/1 + 4 acumuladores de frío + 4 barras cromadas, sin campanas

set de 12: 2 boîtes en bois de hêtre avec bac en plastique + 2 plateaux en acier inox GN 1/1 + 4 accumulateurs de froid + 4 barres chromées, sans cloches

	cm	↑ cm
11547	60 x 41	36

GN Rolltophaube mit schwarzem Griff / GN rolltop cover with black handle / GN campana rolltop con asa negra / GN cloche rolltop avec poignée noir

	cm	↑ cm	GN
11075	53 x 32,5	19	1/1

GN Rolltophaube mit Chromgriff / GN rolltop cover with chrome handle / GN campana rolltop con asa cromada / GN cloche rolltop avec poignée chromée

	cm	↑ cm	GN
11010	53 x 32,5	19	1/1

Kühlakku / cooler / acumulador de frío / accumulateur de froid

	cm	↑ cm
10791	25 x 19	2,5

4 tlg.
4 pcs.



11540



11010

Buche, wasserfest lackiert
beech wood lacquered



10791

Kühlakku halten Ihre Speisen bis zu 6 Stunden kühl
cooling system keeps the food cool for up to 6 hours

Buffetvitrine „TOP FRESH GN 1/1“

refrigerated buffet display
expositor buffet frío
plateau buffet froid



4-teilig: 1 Box aus Buchenholz mit Kunststoffwanne + 1 Edelstahl-Tablett GN 1/1 + 2 Kühlakkus, ohne Haube

4 pcs.: 1 beech wood box with plastic insert + 1 stainless steel tray GN 1/1 + 2 coolers, without cover

set de 4: 1 caja de madera de haya con bandeja de plástico + 1 bandeja de acero inoxidable GN 1/1 + 2 acumuladores de frío, sin campana

set de 4: 1 boîte en bois de hêtre avec bac en plastique + 1 plateau en acier inox GN 1/1 + 2 accumulateurs de froid, sans cloche

	cm	↑ cm
11540	60 x 41	5

GN Rolltophaube mit Goldgriff / GN rolltop cover with gold handle / GN campana rolltop con asa dorada / GN cloche rolltop avec poignée en or

	cm	↑ cm	GN
11008	53 x 32,5	19	1/1

GN Rolltophaube mit Chromgriff / GN rolltop cover with chrome handle / GN campana rolltop con asa cromada / GN cloche rolltop avec poignée chromée

	cm	↑ cm	GN
11010	53 x 32,5	19	1/1

Kühlakku / cooler / acumulador de frío / accumulateur de froid

	cm	↑ cm
10791	25 x 19	2,5

12 tlg.
12 pcs.



11541

Buche, wasserfest lackiert
beech wood lacquered



10791

Kühlakku halten Ihre Speisen bis zu 6 Stunden kühl
cooling system keeps the food cool for up to 6 hours

Buffetvitrine „DOPPELDECKER GN 1/1“

cooling buffet display
expositor buffet frío
vitrine buffet



12-teilig: 2 Boxen aus Buchenholz mit Kunststoffwanne + 2 Edelstahl-Tablets GN 1/1 + 4 Kühlakkus + 4 verchromte Stangen, ohne Hauben

12 pcs.: 2 beech wood boxes with plastic insert + 2 stainless steel trays GN 1/1 + 4 coolers + 4 chrome-plated bars, without covers

set de 12: 2 cajas de madera de haya con bandeja de plástico + 2 bandejas de acero inoxidable GN 1/1 + 4 acumuladores de frío + 4 barras cromadas, sin campanas

set de 12: 2 boîtes en bois de hêtre avec bac en plastique + 2 plateaux en acier inox GN 1/1 + 4 accumulateurs de froid + 4 barres chromées, sans cloches

	cm	↑ cm
11541	60 x 41	36

GN Rolltophaube mit Goldgriff / GN rolltop cover with gold handle / GN campana rolltop con asa dorada / GN cloche rolltop avec poignée en or

	cm	↑ cm	GN
11008	53 x 32,5	19	1/1 Gold-Griff

GN Rolltophaube mit Chromgriff / GN rolltop cover with chrome handle / GN campana rolltop con asa cromada / GN cloche rolltop avec poignée chromée

	cm	↑ cm	GN
11010	53 x 32,5	19	1/1 Chrom-Griff

Kühlakku / cooler / acumulador de frío / accumulateur de froid

	cm	↑ cm
10791	25 x 19	2,5

COOLING DISPLAYS



09100



11101

Kühlakkus halten Ihre Speisen bis zu 6 Stunden kühl
cooling system keeps the food cool for up to 6 hours

Buffetvitrine showcase vitrina de buffet vitrine de buffet



5-teilig: 1 transparente Rolltophaube beidseitig aufklappbar + 1 Schale (ABS) + 1 Edelstahl-Tablett 39 x 28 cm + 2 Kühlakkus

5 pcs.: 1 transparent rolltop cover + 1 tray (ABS) + 1 stainless tray 39 x 28 cm + 2 coolers
set de 5: 1 tapa abatible, por ambos lados, transparente + 1 bandeja (ABS) + 1 bandeja de acero inoxidable 39 x 28 cm + 2 acumuladores de frío

set de 5: 1 cloche transparente ouverture 2 côtés + 1 caisson (ABS) + 1 plateau en acier inox 39 x 28 cm + 2 accumulateurs de froid

	cm	↑ cm	Farbe / Colour
09100	44 x 32	20,5	■
09104	44 x 32	20,5	■

Kühlakku / cooler / acumulador de frío / accumulateur de froid

	cm	↑ cm	pcs.
11101	16 x 7,5	2	4

Edelstahl-Tablett / stainless steel tray / bandeja de acero inoxidable / plateau inox

	cm	↑ cm
90902	39,5 x 28,5	1



Servierbeispiel
presentation example



09200



09204

Buffetvitrine „DOPPELDECKER“ showcase vitrina de buffet, 2 alturas vitrine de buffet double



2 transparente Rolltophauben beidseitig aufklappbar + 2 Schalen (ABS) + 2 Edelstahl-Tabletts 39 x 28 cm + 4 Kühlakkus, platzsparend lagerbar

2 transparent rolltop cover + 2 trays (ABS) + 2 tray 39 x 28 cm + 4 coolers, space saving
2 campanas abatibles por ambos lados transparentes + 2 bandejas (ABS) + 2 bandejas de acero inoxidable 39 x 28 cm + 4 acumuladores de frío, almacenamiento en poco espacio

2 cloches transparentes abattantes 2 côtés + 2 caissons (ABS) + 2 plateaux en acier inox 39 x 28 cm + 4 accumulateurs de froid, peut encombrant à stocker

	cm	↑ cm	Farbe / Colour
09200	44 x 32	44	■
09204	44 x 32	44	■

Kühlakku / cooler / acumulador de frío / accumulateur de froid

	cm	↑ cm	pcs.
11101	16 x 7,5	2	4

Edelstahl-Tablett / stainless steel tray / bandeja de acero inoxidable / plateau inox

	cm	↑ cm
90902	39,5 x 28,5	1



6 tlg.
6 pcs.



09091

09090

09094

09093

Thermo Tablett-Set, 6-teilig

thermo tray, 6 pcs.
bandeja térmica, set de 6
plateau thermique, set de 6



- 6-teilig:
- 1 Schale
 - 1 Edeltahltablett
 - 2 Kühlakkus
 - 1 transparente Frischhaltehaube
 - 1 Transport- und Tragegurt aus Silikon

- 6 pcs.:
- 1 plastic tray
 - 1 stainless steel tray
 - 2 coolers
 - 1 transparent cover
 - 1 silicone transport and carrying strap

- set de 6:
- 1 bandeja de plástico
 - 1 bandeja de acero inoxidable
 - 2 acumuladores de frío
 - 1 campana transparente
 - 1 correa de silicona para cierre y transporte

- set de 6:
- 1 plateau plastique
 - 1 plateau en acier inox
 - 2 accumulateurs de froid
 - 1 cloche transparente
 - 1 sangle en silicone pour fermeture et transport

inklusive
Transport- und
Tragegurt!

	cm	↑ cm	Farbe / Colour
09091	43 x 29	14	■
09090	43 x 29	14	■



inklusive 2 Kühlakkus
including 2 coolers

Thermo Tablett-Set, 6-teilig

thermo tray, 6 pcs.
bandeja térmica, set de 6
plateau thermique, set de 6



- 6-teilig:
- 1 Schale
 - 1 Edeltahltablett
 - 2 Kühlakkus
 - 1 transparente Frischhaltehaube
 - 1 Transport- und Tragegurt aus Silikon

- 6 pcs.:
- 1 plastic tray
 - 1 stainless steel tray
 - 2 coolers
 - 1 transparent cover
 - 1 silicone transport and carrying strap

- set de 6:
- 1 bandeja de plástico
 - 1 bandeja de acero inoxidable
 - 2 acumuladores de frío
 - 1 campana transparente
 - 1 correa de silicona para cierre y transporte

- set de 6:
- 1 plateau plastique
 - 1 plateau en acier inox
 - 2 accumulateurs de froid
 - 1 cloche transparente
 - 1 sangle en silicone pour fermeture et transport

inklusive
Transport- und
Tragegurt!

	cm	↑ cm	Farbe / Colour
09094	35	15	■
09093	35	15	■



inklusive 2 Kühlakkus
including 2 coolers

COOLING DISPLAYS

3 tlg.
3 pcs.



11542

Buche, wasserfest lackiert
beech wood lacquered



18388

11542



10791

Kühlakku halten Ihre Speisen bis zu 6 Stunden kühl
cooling system keeps the food cool for up to 6 hours

Kühltablett „TOP FRESH RUND“

refrigerated buffet display
expositor buffet frío redondo
présentoir buffet



3-teilig: 1 Box aus Buchenholz mit Kunststoffwanne + 1 Edelstahl-Tablett Ø 38 cm
+ 1 Kühlakku, ohne Haube

3 pcs.: 1 beech wood box with plastic insert + 1 stainless tray Ø 38 cm + 1 cooler, without cover

set de 3: 1 caja de madera de haya con bandeja de plástico + 1 bandeja de acero inoxidable Ø 38 cm + 1 acumulador de frío, sin campana

set de 3: 1 boîte en bois de hêtre avec bac en plastique + 1 plateau en acier inox Ø 38 cm + 1 accumulateur de froid, sans cloche

	Ø cm	↑ cm
11542	48	6

Rolltophaube mit verchromtem Kugelgriff / rolltop cover with chrome-plated ball handle / campana abatible con asa de bola cromada / cloche basculante avec poignée boule chromée

	Ø cm	↑ cm
18388	38	20

Rolltophaube mit vergoldetem Kugelgriff / rolltop cover with gold-plated ball handle / campana abatible con asa de bola dorada / cloche basculante avec poignée boule plaquée or

	Ø cm	↑ cm
18387	38	20

Kühlakku / cooler / acumulador de frío / accumulateur de froid

	cm	↑ cm
10791	25 x 19	2,5

11 tlg.
11 pcs.



11543

Buche, wasserfest lackiert
beech wood lacquered



10791

Kühlakku halten Ihre Speisen bis zu 6 Stunden kühl
cooling system keeps the food cool for up to 6 hours

Buffetvitrine „DOPPELDECKER“

double refrigerated buffet display
expositor de buffet redondo doble
présentoir buffet froid, double



11-teilig: 2 Boxen aus Buchenholz mit Kunststoffwanne + 2 Edelstahl-Tablets Ø 38 cm
+ 2 Kühlakkus + 2 Kunststoffschalen + 3 verchromte Stangen, ohne Hauben

11 pcs.: 2 beech wood boxes with plastic tray + 2 stainless steel trays Ø 38 cm, 2 coolers + 3 chrome-plated bars, without covers

set de 11: 2 cajas de madera de haya con bandeja de plástico + 2 bandejas de acero inoxidable Ø 38 cm + 2 acumuladores de frío + 2 bandejas de plástico + 3 barras cromadas, sin campanas

set de 11: 2 boîtes en bois de hêtre avec bac en plastique + 2 plateaux en inox Ø 38 cm + 2 accumulateurs de froid + 2 plateaux en plastique + 3 barres chromées, sans cloches

	Ø cm	↑ cm
11543	48	38

Rolltophaube mit verchromtem Kugelgriff / rolltop cover with chrome-plated ball handle / campana abatible con asa de bola cromada / cloche basculante avec poignée boule chromée

	Ø cm	↑ cm
18388	38	20

Rolltophaube mit vergoldetem Kugelgriff / rolltop cover with gold-plated ball handle / campana abatible con asa de bola dorada / cloche basculante avec poignée boule plaquée or

	Ø cm	↑ cm
18387	38	20

Kühlakku / cooler / acumulador de frío / accumulateur de froid

	cm	↑ cm
10791	25 x 19	2,5

18388

09082

11101

Kühlakkus halten Ihre Speisen bis zu 6 Stunden kühl
cooling system keeps the food cool for up to 6 hours

Thermo-Set
thermo set
bandeja isotérmica
set thermo



5-teilig: 1 Tablett tief + 1 Tablett flach + 2 Kühlakkus + 1 Rolltophaube

5 pcs.: 1 deep tray + 1 tray + 2 cooler + 1 rolltop cover

set de 5: 1 bandeja honda + 1 bandeja plana + 2 acumuladores frío + 1 campana rolltop

set de 5: 1 plateau creux + 1 plateau plat + 2 accumulateurs de froid + 1 cloche rolltop

	Ø cm	↑ cm
09082	38	24

Rolltophaube mit verchromtem Kugelgriff / rolltop cover with chrome-plated ball handle / campana abatible con asa de bola cromada / cloche basculante avec poignée boule chromée

	Ø cm	↑ cm
18388	38	20

Kühlakku / cooler / acumulador de frío / accumulateur de froid

	cm	↑ cm	pcs.
11101	16 x 7,5	2	4

4 tlg.
4 pcs.

09083

11101

Kühlakkus halten Ihre Speisen bis zu 6 Stunden kühl
cooling system keeps the food cool for up to 6 hours

Thermo-Set
thermo set
porta tartas refrigerado
porte-gâteau réfrigéré



4-teilig: 1 Tablett tief auf Fuß + 1 Tablett flach + 2 Kühlakkus

4 pcs.: 1 deep tray with feet + 1 tray + 2 coolers

set de 4: 1 bandeja honda con pie + 1 bandeja plana + 2 acumuladores de frío

set de 4: 1 plateau creux avec pied + 1 plateau plat + 2 accumulateurs de froid

	Ø cm	↑ cm
09083	38	14,5

Rolltophaube mit verchromtem Kugelgriff / rolltop cover with chrome-plated ball handle / campana abatible con asa de bola cromada / cloche basculante avec poignée boule chromée

	Ø cm	↑ cm
18388	38	20

Kühlakku / cooler / acumulador de frío / accumulateur de froid

	cm	↑ cm	pcs.
11101	16 x 7,5	2	4

COOLING DISPLAYS

4 tlg.
4 pcs.

9 cm

11812 0,6 ltr.

11,5 cm

11813 1 ltr.

10661

Kühlakku halten Ihre Speisen bis zu 6 Stunden kühl
cooling system keeps the food cool for up to 6 hours

KühlSchale Mini Holz „TOP FRESH“

cool bowl mini holz
bol refrigerado mini madera
bol réfrigéré mini bois



4-teilig: 1 Fuß Buchenholz versiegelt + 1 Schale + 1 Kühlakku + 1 klappbarer Deckel mit Beschriftungsschild

4 pcs.: 1 foot beech wood + 1 bowl + 1 cooler + 1 hinged cover with label
set de 4: 1 base de madera de haya + 1 cuenco + 1 acumulador de frío + 1 tapa abatible con etiqueta
set de 4: 1 pied en hêtre + 1 bac + 1 accumulateur de froid + 1 couvercle à charnière avec étiquette

	Ø cm	↑ cm	ltr.
11812	14	9,0	0,6
11813	14	11,5	1,0

Ersatzschale / spare bowl / cuenco de recambio / bol de rechange

	Ø cm	↑ cm
11811	14	6,5
11816	14	9,0

Schutzdeckel mit Löffelaussparung / cover / tapa / couvercle

	Ø cm
11868	14,5

Kühlakku / cooler / acumulador de frío / accumulateur de froid

	Ø cm	↑ cm
10661	10,5	2

4 tlg.
4 pcs.

14 cm

11817
2,5 ltr.

18 cm

11818
4 ltr.

KühlSchale Maxi Holz „TOP FRESH“

cool bowl maxi holz
bol refrigerado maxi madera
bol réfrigéré maxi bois



4-teilig: 1 Fuß Buchenholz versiegelt + 1 Schale + 1 Kühlakku + 1 klappbarer Deckel mit Beschriftungsschild

4 pcs.: 1 foot beech wood + 1 bowl + 1 cooler + 1 hinged cover with label
set de 4: 1 base de madera de haya + 1 cuenco + 1 acumulador de frío + 1 tapa abatible con etiqueta
set de 4: 1 pied en hêtre + 1 bac + 1 accumulateur de froid + 1 couvercle à charnière avec étiquette

	Ø cm	↑ cm	ltr.
11817	22	14	2,5
11818	22	18	4,0

Ersatzschale / spare bowl / cuenco de recambio / bol de rechange

	Ø cm	↑ cm
11846	22	8
11848	22	12

Schutzdeckel mit Löffelaussparung / cover / tapa / couvercle

	Ø cm
11878	23,5

Kühlakku / cooler / acumulador de frío / accumulateur de froid

	Ø cm	↑ cm
10777	15	2,5

4 tlg.
4 pcs.



9 cm

11812 0,6 ltr.



11,5 cm

11815 1 ltr.



10661

Kühlakku halten Ihre Speisen bis zu 6 Stunden kühl
cooling system keeps the food cool for up to 6 hours

Kühlschale Mini „TOP FRESH“

cool bowl mini
bol refrigerado mini
bol réfrigéré mini



4-teilig: 1 Edelstahlgefäß matt + 1 Kühlakku + 1 Schale + 1 klappbarer Deckel mit Beschriftungsschild

4 pcs.: 1 stainless steel bowl matt + 1 bowl + 1 cooler + 1 hinged cover with label
set de 4: 1 recipiente de acero inoxidable mate + 1 cuenco + 1 acumulador de frío + 1 tapa abatible con etiqueta

set de 4: 1 récipient en acier inox mat + 1 bac + 1 accumulateur de froid + 1 couvercle à charnière avec étiquette

	Ø cm	↑ cm	ltr.
11810	14	9,0	0,6
11815	14	11,5	1,0

Ersatzschale / spare bowl / cuenco de recambio / bol de rechange

	Ø cm	↑ cm
11811	14	6,5
11816	14	9,0

Schutzdeckel mit Löffelaussparung / cover / tapa / couvercle

	Ø cm
11868	14,5

Kühlakku / cooler / acumulador de frío / accumulateur de froid

	Ø cm	↑ cm
10661	10,5	2

4 tlg.
4 pcs.



14 cm

11847 2,5 ltr.



18 cm

11849 4 ltr.

Kühlschale Maxi „TOP FRESH“

cool bowl maxi
bol refrigerado maxi
bol réfrigéré maxi



4-teilig: 1 Edelstahlgefäß hochglanzpoliert + 1 Kühlakku + 1 Schale + 1 klappbarer Deckel mit Beschriftungsschild

4 pcs.: 1 stainless steel bowl matt + 1 bowl + 1 cooler + 1 hinged cover with label
set de 4: 1 recipiente de acero inoxidable mate + 1 cuenco + 1 acumulador de frío + 1 tapa abatible con etiqueta

set de 4: 1 récipient en acier inox mat + 1 bac + 1 accumulateur de froid + 1 couvercle à charnière avec étiquette

	Ø cm	↑ cm	ltr.
11847	22	14	2,5
11849	22	18	4,0

Ersatzschale / spare bowl / cuenco de recambio / bol de rechange

	Ø cm	↑ cm
11846	22	8
11848	22	12

Schutzdeckel mit Löffelaussparung / cover / tapa / couvercle

	Ø cm
11878	23,5

Kühlakku / cooler / acumulador de frío / accumulateur de froid

	Ø cm	↑ cm
10777	15	2,5

COOLING DISPLAYS



11845
2,5 ltr.



11875

Kühlschale Maxi „TOP FRESH“

cool bowl maxi
cuenco refrigerado maxi
bol réfrigéré maxi



4-teilig: 1 Gefäß hochglanzpoliert + 1 Kühlakku + 1 Glasschale + 1 klappbarer Deckel mit Beschriftungsschild

4 pcs.: 1 stainless steel bowl mirror polished + 1 cooler + 1 glass bowl + 1 hinged cover with label

set de 4: 1 recipiente de acero inoxidable pulido brillante + 1 acumulador de frío + 1 cuenco de vidrio + 1 tapa abatible con etiqueta

set de 4: 1 récipient en acier inox poli mat + 1 accumulateur de froid + 1 bol en verre + 1 couvercle à charnière avec étiquette

	Ø cm	↑ cm	ltr.
11845	23	14	2,5

Ersatzschale / spare bowl / cuenco de recambio / bol de rechange

	Ø cm	↑ cm	ltr.
11875	23	10,5	2,5

Schutzdeckel mit Löffelaussparung / cover / tapa / couvercle

	Ø cm
11878	23,5

Kühlakku / cooler / acumulador de frío / accumulateur de froid

	Ø cm	↑ cm
10777	15	2,5

Schale „CASUAL MAXI“

bowl
cuenco
bol



83696



83705

	Ø cm	↑ cm	ltr.	Farbe / Colour
83696	10	4,5	0,15	White
83698	12	5,5	0,25	White
83700	14	6,5	0,50	White
83704	20	9,2	1,80	White
83702	23	10,5	2,50	White

	Ø cm	↑ cm	ltr.	Farbe / Colour
83697	10	4,5	0,15	Black
83699	12	5,5	0,25	Black
83701	14	6,5	0,50	Black
83705	20	9,2	1,80	Black
83703	23	10,5	2,50	Black

SNACKPRESENTER



Snackpresenter

snackpresenter
dispensador de bocadillos
présentoir à sandwiches
mit Safrille und Griffmulde, passend für Vitrine 11888



with recessed grip, suitable for showcase 11888
asa moldeada, apto para la vitrina 11888
anse moulée, apte pour vitrine 11888

	cm	↑ cm	
11887	29 x 19	6,5	3 Mulden / 3 compartments 3 compartimentos / 3 compartments
11889	60 x 19	7,5	6 Mulden / 6 compartments 6 compartimentos / 6 compartments



Snackpresenter

snackpresenter
dispensador de bocadillos
présentoir à sandwiches
hochglanzpoliert, mit Griffmulde, für 7 Baguettes



mirror polished, with recessed grip, for 7 baguettes
pulido brillante, con asa empotrada, ideal para 7 bocadillos
poli brillant, avec poignée encastrée, parfait pour 7 sandwiches

	cm	↑ cm
11891	47,5 x 10,5	6



Snackpresenter

snackpresenter
dispensador de bocadillos
présentoir à sandwiches



	cm	↑ cm
11969	56 x 8	5,5



Vitrine / Thekenaufsatz

showcase
vitrina de mostrador
vitrine de comptoir
rutschfest, aus einem Teil gefertigt



non-slip, monoblock produced
antideslizante, fabricado en 1 pieza
antidérapante, fabriquée en une seule pièce

	cm	↑ cm
11888	63,5 x 25	25

BUFFET GUARD

3 Höhen einstellbar
3 heights adjustable



schwenkbar
swivelling

Servierbeispiel
presentation example



Hygieneschutz „BUFFET GUARD“

sneeze guard
protector anti aliento
pare-haleine



- transparente, höhenverstellbare Acrylplatte 80 x 53 cm
- Neigungswinkel stufenlos einstellbar
- transparent, height-adjustable acrylic plate 80 x 53 cm
- tilt angle continuously adjustable
- placa acrílica transparente y de altura ajustable 80 x 53 cm
- el ángulo de inclinación es infinitamente variable
- plaque en acrylique transparente 80 x 53 cm et réglable en hauteur
- angle d'inclinaison variable à l'infini

	cm	↑ cm	✂ mm	Fuß / base
98120	93 x 53	50,5	5	Metall schwarz / metal black



Antirutschfüßchen
non-slip feet



Der Neigungswinkel der Acrylplatte ist flexibel einstellbar
the angle of inclination of the acrylic plate is flexibly adjustable



Höheneinstellung der Acrylplatte in 3 Höhen (20 cm - 30 cm - 40 cm)
height adjustment of the acrylic plate in 3 steps. (20 cm - 30 cm - 40 cm)



Anwendungsbeispiel
application example



Lieferung erfolgt demontiert
delivery takes place disassembled



Hygieneschutz
hygienic cover
campana higiénica antialiento
pare-haleine



	cm	↑ cm
11556	82 x 42	45



Brötchenspender
roll dispenser
dispensador de panecillos
distributeur de petits pains



hygienisch und einfach zu reinigen, mit Krümelschale
hygienic and easy to clean, with crumb tray
higiénico y fácil de limpiar, con bandeja para migas
hygiénique et facile à laver, avec plat ramasse-miettes

	cm	↑ cm	
11572	32,5 x 27,5	42	für ca. 45-50 Brötchen / for approx. 45-50 rolls para 45-50 panecillos / pour 45-50 petits pains
11573	32,5 x 27,5	56	für ca. 65-70 Brötchen / for approx. 65-70 rolls para 65-70 panecillos / pour 65-70 petits pains



Buffetgestell
buffet stand
soporte para buffet
présentoir buffet



3-stufig, Rubberwood, geeignet für Körbe, platzsparend zusammenklappbar
3-tier, rubberwood, usable for baskets, can be bushed together for place saving
3 alturas, madera de caucho, apto para cestas, se puede plegar para ahorrar espacio
3 hauteurs, bois d'hévéa, pour corbeilles, la structure s'ouvre ou se ferme pour réduire l'encombrement

	cm	↑ cm
33232	59 x 30,5	59

Tisch- und Buffetkorb, rund „ECONOMIC“ / buffet basket, round / cesta de buffet redonda / corbeille de buffet ronde

	Ø cm	↑ cm	Farbe / Colour
40144	39,0	10,0	Yellow

Lieferung ohne Körbe
delivery without baskets

DRAWER SET



50807
2 x Korb, schwarz

00910
3-teiliges Set
3 pcs. set



3 tlg.
3 pcs.



00910



00911
mit Antirutsch Füßchen
with non-slip feet



00912

Schubladen Set, 3-teilig

drawer set, 3 pcs.
cajonera, set de 3
set tiroir, set de 3

3-teiliges Set:

- 1 Ständer aus Metall schwarz
- 1 Schublade mit Griff schwarz
- 1 Schneidebrett aus geöltem Walnussholz

3 pcs. set:

- 1 stand made of metal black
- 1 drawer with handle black
- 1 oiled walnut wood cutting board

set de 3:

- 1 soporte de metal negro
- 1 cajón con asa negra
- 1 tabla de cortar de madera de nogal engrasada

set de 3:

- 1 support métallique noir
- 1 tiroir avec poignée noire
- 1 planche à découper en bois de noyer huilé

HOLZ WOOD ACRYL ACRYLIC METALL METAL

	cm	↑ cm
00910	35,4 x 32,5	20



15506

00912



00911

Anwendungsbeispiele
application examples

Einzelteile / parts / piezas / pièces

	cm	↑ cm	
00911	35,4 x 32,5	3,5	Schneidebrett / cutting board
00912	34,0 x 32,0	17,5	Schublade, Griff schwarz / drawer, handle black
00914	34,0 x 32,0	17,5	Schublade, Griff chrom / drawer, handle chrome
15506	35,4 x 32,5	17,6	GN Buffetständer schwarz/ GN buffet stand black



Neigungswinkel stufenlos einstellbar
inclination angle continuously adjustable

für 3 versch. Haubengrößen
for 3 different cover sizes

06519 Ø 21 cm
06520 Ø 30 cm
06521 Ø 36 cm

Haubenthalterung „FLEXIBLE“

cover holder
soporte de la campana
support de la cloche



Bei dieser Haubenthalterung wird die Haube am Griff in die Vorrichtung gesteckt.

Für APS-Hauben geeignet!

With this cover holder, the cover is inserted into the device by the handle.
Suitable for APS covers!

Con este soporte de campana, la campana se cuelga simplemente por el asa.

¡Para campanas de APS!

Avec ce support, la cloche s'accroche simplement par la poignée.

Pour cloches APS!

	cm	↑ cm
33288	35,5 x 30	39

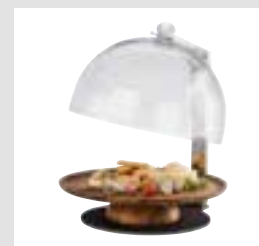

Anwendungsbeispiele
application examples



2 tlg.
2 pcs.

24 cm

Haube | cover
Ø 16 cm

Tablett | tray
Ø 18,5 cm

Tablett mit Haube

tray with cover
bandeja con campana
plateau avec cloche

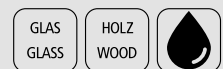

2 teiliges Set:

- 1 Tablett aus geöltem Buchenholz (Ø 18,5 cm, H: 2,5 cm)
- 1 Glas-Haube (Ø 16 cm, H: 22,5 cm)

2 pcs.:

- 1 tray of oiled beech wood (Ø 18,5 cm, H: 2,5 cm)
- 1 glass cover (Ø 16 cm, H: 22,5 cm)

set de 2:

- 1 bandeja de madera de haya (Ø 18,5 cm, H: 2,5 cm)
- 1 campana de cristal (Ø 16 cm, H: 22,5 cm)

set de 2:

- 1 plateau de bois de hêtre (Ø 18,5 cm, H : 2,5 cm)
- 1 couvercle en verre (Ø 16 cm, H : 22,5 cm)

	Ø cm	↑ cm
00830	18,5	24



Präsentationsmöglichkeit
presentation example

FRIENDLY



- hergestellt aus gebrauchtem Kunststoff – aus recyceltem Post-Consumer PET
- recycelbar und umweltschonend
- made from used plastic – made of recycled post-consumer PET
- recyclable and environmentally friendly
- fabricado de plástico usada: de PET reciclado postconsumo
- reciclable y ecológico
- fabriqué de plastique usagée – composé à de PET recyclé post-consummation
- recyclable et écologique



79022 0,05 ltr.



79001 0,14 ltr.



79002 0,4 ltr.



79005 1,5 ltr.



79008 3,8 ltr.

Schale „FRIENDLY“ bowl cuenco bol



friendly

	cm	↑ cm	ltr.	Farbe / Colour	VE / unit
79022	6,5 x 6,5	3,0	0,05		6
79023	6,5 x 6,5	3,0	0,05		6
79000	9,0 x 9,0	4,0	0,14		–
79001	9,0 x 9,0	4,0	0,14		–
79002	12,5 x 12,5	6,5	0,40		–
79003	12,5 x 12,5	6,5	0,40		–
79004	19,0 x 19,0	9,0	1,50		–
79005	19,0 x 19,0	9,0	1,50		–
79008	25 x 25	12,0	3,8		–
79009	25 x 25	12,0	3,8		–



Präsentationsmöglichkeit
presentation example



Dipschälchen „FRIENDLY“
dip bowl
cuenco para dip
ramequin



	Ø cm	↑ cm	ltr.	Farbe / Colour	VE / unit
79014	6	4,0	0,05	White	6
79015	6	4,0	0,05	Black	6



Schälchen „FRIENDLY“
mini bowl
mini cuenco
mini bol



	Ø cm	↑ cm	ltr.	Farbe / Colour	VE / unit
79016	6,0	2,5	0,02	White	12
79017	6,0	2,5	0,02	Black	12
79018	7,5	3,5	0,05	White	12
79019	7,5	3,5	0,05	Black	12
79020	10,0	4,5	0,15	White	–
79021	10,0	4,5	0,15	Black	–



Schale „FRIENDLY“
bowl
cuenco
bol



	Ø cm	↑ cm	ltr.	Farbe / Colour
79024	14	6,5	0,5	White
79025	14	6,5	0,5	Black
79026	20	9	1,8	White
79027	20	9	1,8	Black
79028	23	10,5	2,5	White
79029	23	10,5	2,5	Black



Schale „FRIENDLY“
bowl
cuenco
bol



friendly

	cm	↑ cm	ltr.	Farbe / Colour	VE / unit
79038	7,5 x 7	4,5	0,05	White	12
79039	11,5 x 7,5	3,0	0,06	White	12
79040	11,5 x 6	5,5	0,04	White	12
79041	8,5 x 7	6,0	0,07	White	12



Fingerfoodlöffel „FRIENDLY“
party spoon
cuchara party
cuillère party



friendly

	cm	↑ cm	Farbe / Colour	VE / unit
79010	13,5 x 4,5	4,5	White	12
79011	13,5 x 4,5	4,5	Black	12



Fingerfoodlöffel „FRIENDLY“
party spoon
cuchara party
cuillère party



friendly

	cm	↑ cm	Farbe / Colour	VE / unit
79012	11 x 4,5	4,0	White	12
79013	11 x 4,5	4,0	Black	12



GN Tablett „FRIENDLY“

GN tray
GN bandeja
GN plateau



	cm	↑ cm	Farbe / Colour	GN
79006	32,5 x 26,5	3,0		1/2
79007	32,5 x 26,5	3,0		1/2



GN Behälter „FRIENDLY“

GN pan
GN cubeta
GN bac



	cm	↑ cm	ltr.	Farbe / Colour	GN
79030	53 x 32,5	6,5	7,1		1/1
79031	53 x 32,5	6,5	7,1		1/1
79032	32,5 x 26,5	6,5	3,4		1/2
79033	32,5 x 26,5	6,5	3,4		1/2
79034	32,5 x 17,6	6,5	2		1/3
79035	32,5 x 17,6	6,5	2		1/3
79036	32,5 x 17,6	10	2,7		1/3
79037	32,5 x 17,6	10	2,7		1/3



NEW



30024



30014



30013



30010



30011

Schale „FROSTFIRE“

bowl
cuenco
bol



Antihafbeschichtung / non stick coating / antiadherente / revêtement anti-adhésif

	Ø cm	↑ cm	ltr.	Farbe / Colour	
30024	32,5	8 / 14	3		beige/sand
30014	32,5	8 / 14	3		red
30013	32,5	8 / 14	3		green
30010	32,5	8 / 14	3		black/silver
30011	32,5	8 / 14	3		black



Präsentationsmöglichkeit
presentation example

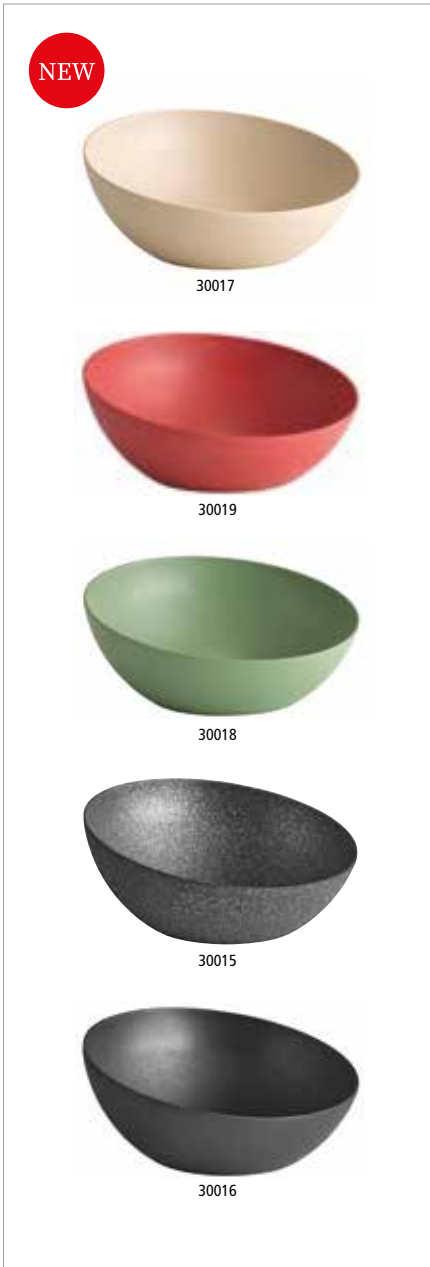

Schale „FROSTFIRE“

bowl
cuenco
bol



Antihafbeschichtung / non stick coating / antiadhérente / revêtement anti-adhésif

	Ø cm	↑ cm	ltr.	Farbe / Colour
30017	26,5	7 / 12	1,9	beige/sand
30019	26,5	7 / 12	1,9	red
30018	26,5	7 / 12	1,9	green
30015	26,5	7 / 12	1,9	black/silver
30016	26,5	7 / 12	1,9	black



Wärmelampe mit 2 Infrarotlampen

thermal bridge
puente térmico
pont thermique



höhenverstellbar 58 - 77,5 cm, inklusive 2 Lampen, Kabellänge: 1,5 Meter

height ajustable from 58 to 77,5 cm, including 2 infrared lamps, cable length: 1,5 metres
regulable en altura de 58 a 77,5 cm, con 2 lámparas de infrarrojos, longitud del cable: 1,5 metros
réglable en hauteur de 58 à 77,5 cm, avec 2 lampes infrarouges, longueur du câble: 1,5 mètre

	cm	↑ cm	V	W	Farbe / Colour
12265	50 x 35	58 - 77,5	230	2 x 250	

Ersatzbirne für Wärmelampe

infrared lamp / bulb
lámpara infrarrojos / bombilla
lampe infrarouge / ampoule

Fassung E27, Lichtfarbe: warmweiß

socket: E27, light colour: warm white

casquillo: E27, color de la luz: blanco cálido

douille: E27, couleur de lumière: blanc chau

	W	fits to
12266	250	12265



FROSTFIRE



FROSTFIRE Schalen und Tablett aus gegossenem Aluminium leiten die Wärme und Kälte nicht nur gut, sondern können diese auch lange speichern – ideal für den Einsatz in Kühlvitrienen, -regalen, auf Kühlischen und unter Wärmelampen. FROSTFIRE Schalen und Tablett halten servierbereite Speisen zuverlässig warm oder kalt.

FROSTFIRE bowls and trays made of cast aluminium not only conduct heat and cold well, but can also store it for a long time - ideal for use in refrigerated display cabinets, shelves, on refrigerated tables and under heat lamps. FROSTFIRE bowls and trays reliably keep ready-to-serve food warm or cold.

Los cuencos y las bandejas FROSTFIRE de aluminio fundido no sólo conducen bien el calor y el frío, sino que también pueden conservarlo durante mucho tiempo: ideales para su uso en vitrinas refrigeradas, estanterías, mesas refrigeradas y bajo lámparas de calor. Los cuencos y las bandejas FROSTFIRE mantienen de forma fiable los alimentos listos para servir calientes o fríos.

Les bols et plateaux FROSTFIRE en aluminium moulé conduisent non seulement bien la chaleur et le froid, mais peuvent aussi les conserver longtemps - idéal pour une utilisation dans des vitrines et étagères réfrigérées, sur des tables réfrigérées et sous des lampes chauffantes. Les bols et plateaux FROSTFIRE maintiennent les aliments prêts à être servis au chaud ou au froid de manière fiable.

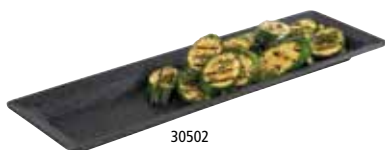

GN Tablett „FROSTFIRE“

GN tray
GN bandeja
GN corbeille



Antihftbeschichtung / non stick coating / antiadherente / revêtement anti-adhésif

	cm	↑ cm	GN	Farbe / Colour
30500	53 x 32,5	3	1/1	black/silver
30501	32,5 x 26,5	3	1/2	black/silver
30502	53 x 16,2	3	2/4	black/silver





Schale „FROSTFIRE“

bowl
cuenco
bol



Antihafbeschichtung / non stick coating / antiadherente / revêtement anti-adhésif

	cm	↑ cm	ltr.	Farbe / Colour
30503	19 x 19	9	1,5	black/silver
30504	25 x 25	12	3,8	black/silver

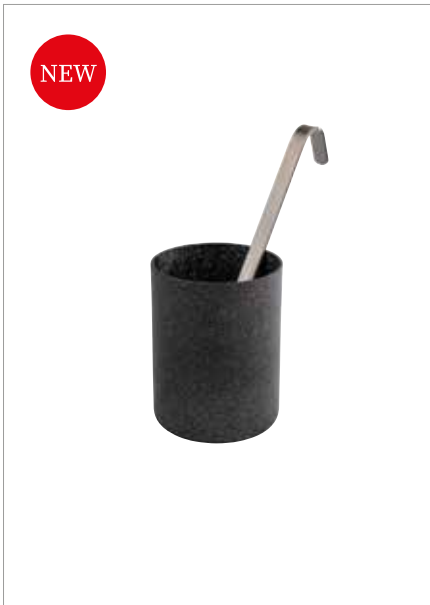

Dressingtopf / Flaschenkühler „FROSTFIRE“

dressing pot / bottle cooler
salsera / enfriador de botella
pot à sauce / rafraîchisseur



Antihafbeschichtung / non stick coating / antiadherente / revêtement anti-adhésif

	Ø cm	↑ cm	ltr.	Farbe / Colour
36140	11,5 / 11	15	1,5	black/silver



auch als Flaschenkühler verwendbar
also usable as a bottle cooler



Wärmelampe mit 2 Infrarotlampen

thermal bridge
puente térmico
pont thermique



höhenverstellbar 58 - 77,5 cm, inklusive 2 Lampen, Kabellänge: 1,5 Meter

height ajustable from 58 to 77,5 cm, including 2 infrared lamps, cable length: 1,5 metres
regulable en altura de 58 a 77,5 cm, con 2 lámparas de infrarrojos, longitud del cable: 1,5 metros
réglable en hauteur de 58 à 77,5 cm, avec 2 lampes infrarouges, longueur du câble: 1,5 mètre

	cm	↑ cm	V	W	Farbe / Colour
12265	50 x 35	58 - 77,5	230	2 x 250	black

Ersatzbirne für Wärmelampe

infrared lamp / bulb
lámpara infrarrojos / bombilla
lampe infrarouge / ampoule

Fassung E27, Lichtfarbe: warmweiß

socket: E27, light colour: warm white

casquillo: E27, color de la luz: blanco cálido

douille: E27, couleur de lumière: blanc chaud

	W	fits to
12266	250	12265

PERFECTO



2-stufige Etagère „PERFECTO SMALL“

2-tier tray
bandeja dos alturas
étagère carré 2 hauteurs



3-teiliges Set, bestehend aus:

- 1 Buffetständer, Metall, PVC, schwarz, 23 x 19 cm, H: 40,5 cm
- 2 Bretter aus Eichenholz, geölt, 20 x 20 cm, H: 2 cm

3 pcs., consisting of:

- 1 buffet stand, metal, PVC, black, 23 x 19 cm, h: 40,5 cm
- 2 boards, oiled oak, 20 x 20 cm, h: 2 cm

set de 3, compuesto por:

- 1 soporte buffet, metal, PVC, negro, 23 x 19 cm, a: 40,5 cm
- 2 tablas de roble, aceitadas, 20 x 20 cm, a: 2 cm

set de 3, composé de :

- 1 support de buffet, métal, PVC, noir, 23 x 19 cm, h: 40,5 cm
- 2 planches en bois de chêne, huilées, 20 x 20 cm, h: 2 cm

	cm	↑ cm
33300	20 x 23	40,5

Brett aus Eichenholz / oak board / tabla de roble / planche en chêne

	cm	↑ cm
33302	20 x 20	2

Buffetständer / buffet stand / soporte de buffet / support de buffet

	cm	↑ cm
33304	19 x 23	40,5



Präsentationsmöglichkeit
presentation example



4 tlg.
4 pcs.

33301
4-teiliges Set | 4 pcs.

33303

33304

2-stufige Etagère „PERFECTO LARGE“

2-tier tray
bandeja dos alturas
étagère carré 2 hauteurs



4-teiliges Set, bestehend aus:

- 2 Buffetständer, Metall, PVC, schwarz, 23 x 19 cm, H: 40,5 cm
- 2 Bretter aus Eichenholz, geölt, 80 x 20 cm, H: 2 cm

4 pcs., consisting of:

- 2 buffet stands, metal, PVC, black, 23 x 19 cm, h: 40,5 cm
- 2 boards, oiled oak, 80 x 20 cm, h: 2 cm

set de 4, compuesto por:

- 2 soportes buffet, metal, PVC, negro, 23 x 19 cm, a: 40,5 cm
- 2 tablas de roble, aceitadas, 80 x 20 cm, a: 2 cm

set de 4, composé de :

- 2 supports de buffet, métal, PVC, noir, 23 x 19 cm, h: 40,5 cm
- 2 planches en bois de chêne, huilées, 80 x 20 cm, h: 2 cm

	cm	↑ cm
33301	80 x 23	40,5

Brett aus Eichenholz / oak board / tabla de roble / planche en chêne

	Ø cm	↑ cm
33303	80 x 20	2

Buffetständer / buffet stand / soporte de buffet / support de buffet

	cm	↑ cm
33304	19 x 23	40,5



Präsentationsmöglichkeit
presentation example

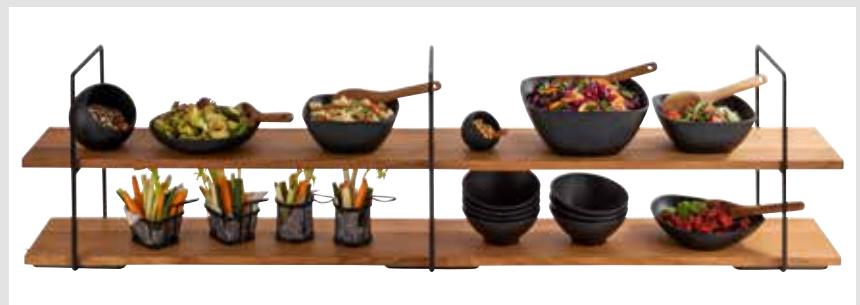

Präsentationsmöglichkeit 3 Buffetständer + 4 Bretter
presentation example 3 buffet stands / 4 boards



platzsparend
space saving

BUFFET STAND

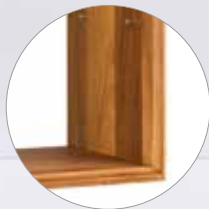

Eichenholz geölt
oak wood oiled

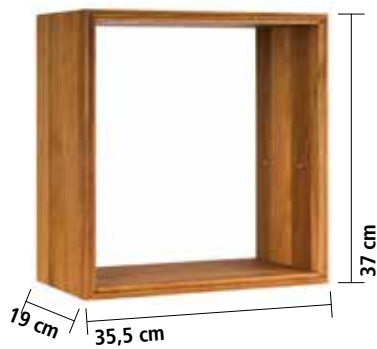

83481
GN 1/3



83491
GN 1/3

Buffetständer „WINDOW“

buffet stand
soporte para buffet
présentoir buffet

Eichenholz geölt
oak wood oiled
madera de roble aceitada
bois de chêne huilé



	cm	↑ cm	
11740	35,5 x 19	37	inkl. 20 Haltestiften für Einlegeböden / incl. 20 fixing pins for shelves



inklusive 20 Haltestifte
including 20 fixing pins



Präsentationsmöglichkeiten
presentation examples

geeignet für GN 1/3 Tablett / for GN 1/3 trays / para bandejas GN 1/3 / pour plateaux GN 1/3

	cm	↑ cm	Farbe / Colour
84187	32,5 x 17,6	1,5	
83481	32,5 x 17,6	3,0	
83491	32,5 x 17,6	3,0	

NEW



Buffet Box

buffet box
caja buffet
boîte à buffet

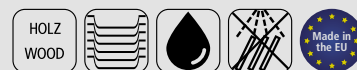

Eichenholz, geölt, Innenmaße: 15,5 x 10 cm

oak wood oiled, interior dimensions: 15,5 x 10 cm
madera de roble aceitada, medidas int.: 15,5 x 10 cm
bois de chêne huilé, dimensions int.: 15,5 x 10 cm

	cm	↑ cm
11728	17,5 x 15,5	12,5

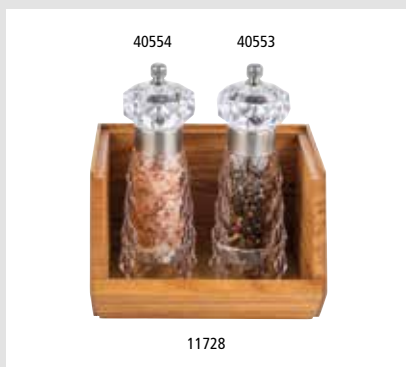

Präsentationsmöglichkeit
presentation example



stapelbar
stackable

NEW



Buffet Box

buffet box
caja buffet
boîte à buffet

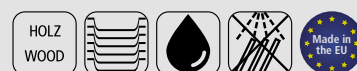

aus geöltem Eichenholz, 2 Fächer je: 25 x 16 cm, mit 2 Griffmulden

made of oiled oak wood, 2 compartments: each 25 x 16 cm, with 2 recessed grips
de madera de roble aceitada, 2 compartimentos de 25 x 16 cm, con 2 asas empotradas
en bois de chêne huilé, 2 compartiments: chacun 25 x 16cm, avec 2 poignées encastrées

	cm	↑ cm
11729	35 x 31	12,5



Präsentationsmöglichkeit
presentation example

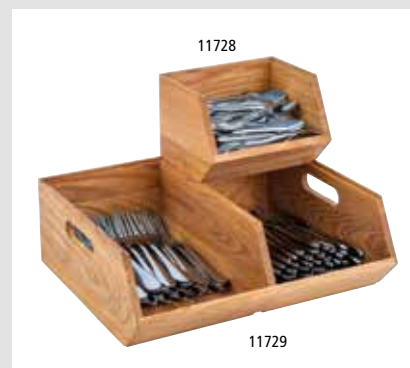

stapelbar
stackable

BUFFET BOX



Buffet Box „TOAST BOX“

buffet box
caja de buffet
boîte de buffet





aus geöltem Eichenholz, Deckel aus Kunstleder, 2 Fächer: 28 x 16,5 cm, H: 16 cm, mit herausnehmbarem Sichtfenster aus Acryl

made of oiled oak wood, lid made of imitation leather, 2 compartments: 28 x 16.5 cm, H: 16 cm, with removable viewing window made from acrylic

de madera de roble aceitada, tapa de polipiel, 2 compartimentos: 28 x 16,5 cm, H: 16 cm, con ventanilla acrílica extraíble

en bois de chêne huilé, couvercle en simili-cuir, 2 compartiments : 28 x 16,5 cm, H : 16 cm, avec fenêtre amovible en acrylique

	cm	↑ cm	Farbe / Colour
11713	36 x 33,5	16	 natural oak
11714	36 x 33,5	16	 dark oak



Präsentationsmöglichkeit
presentation example



Buffet Box „SEWING BASKET“

buffet box
caja de buffet
boîte de buffet



aus geöltem Eichenholz, 3 Fächer: 33 x 27 cm, H: 7 cm, passend für GN 1/2

made of oiled oak wood, 3 compartments: 33 x 27 cm cm, H: 7 cm, suitable for GN 1/2

de madera de roble aceitada, 3 compartimentos: 33 x 27 cm, H: 7 cm, para GN 1/2

en bois de chêne huilé, 3 compartiments: 33 x 27 cm, H: 7 cm, pour GN 1/2

	cm	↑ cm	Farbe / Colour
11711	36 x 29	28	 natural oak
11712	36 x 29	28	 dark oak

geschlossen | closed
37 x 29 cm, H: 28 cm

geöffnet | open
70,5 x 37 cm, H: 53,5 cm



Präsentationsmöglichkeit
presentation example



Buffetgestell „TRIANGLE“

buffet stand
expositor de buffet
présentoir buffet



Buche massiv, 3 Ebenen: 1.: 53 x 19 cm, 2.: 40 x 17,5 cm, 3.: 30 x 15 cm

beech maple, 3 levels: 1.: 53 x 19 cm, 2.: 40 x 17,5 cm, 3.: 30 x 15 cm

haya sólido, 3 niveles: 1.: 53 x 19 cm, 2.: 40 x 17,5 cm, 3.: 30 x 15 cm

hêtre massif, 3 niveaux: 1.: 53 x 19 cm, 2.: 40 x 17,5 cm, 3.: 30 x 15 cm

	cm	↑ cm	Farbe / Colour	
13966	53 x 21	50		Wenge / wenge

Buche massiv, 3 Ebenen: 1.: 53 x 19 cm, 2.: 40 x 17,5 cm, 3.: 30 x 15 cm

beech maple, 3 levels: 1.: 53 x 19 cm, 2.: 40 x 17,5 cm, 3.: 30 x 15 cm

haya sólido, 3 niveles: 1.: 53 x 19 cm, 2.: 40 x 17,5 cm, 3.: 30 x 15 cm

hêtre massif, 3 niveaux: 1.: 53 x 19 cm, 2.: 40 x 17,5 cm, 3.: 30 x 15 cm

	cm	↑ cm	Farbe / Colour	
14966	53 x 21	50		Wenge / wenge



Buffetgestell „BIRDCAGE“

buffet stand
soporte para buffet
présentoir buffet



Gestell aus schwarzem Metall, inklusive 2 Akazienholzplatten

black metal frame, incl. 2 acacia wood panels

soporte metálico negro, con 2 tablas de madera de acacia

support métallique noir, avec 2 panneaux en bois d'acacia

	Ø cm	↑ cm
33206	26	54

Ersatz-Holzplatte

spare wooden panel

tabla de madera de recambio

panneau en bois de rechange

	Ø cm	↑ cm
33207	25	1



passende Akazienholzplatte
fitting acacia wood panels



Gestell mit abgerundeten Füßen
frame with rounded feet

SERVING STANDS

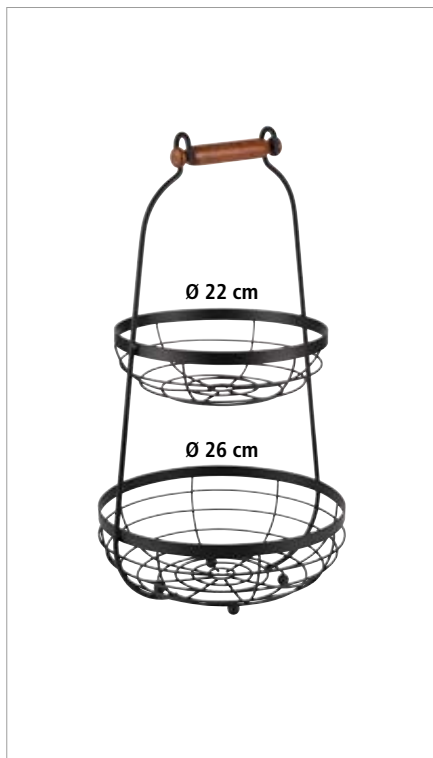

2-stufige Etagère

2-tier étagère
cesta doble 2 alturas
étagère 2 paniers

Griff aus Holz, Körbe aus Metall schwarz,
oberer Korb (Ø 22 cm, H: 6 cm), unterer Korb (Ø 26 cm, H: 8 cm)

wooden handle, baskets made of metal black,
upper basket (Ø 22 cm, H: 6 cm), lower basket (Ø 26 cm, H: 8 cm)

asa de madera, cestas de metal negro,
cesta superior (Ø 22 cm, H: 6 cm), cesta inferior (Ø 26 cm, H: 8 cm)

manche en bois, corbeilles en métal noir,
corbeille supérieure (Ø 22 cm, H: 6 cm), corbeille inférieure (Ø 26 cm, H: 8 cm)



	Ø cm	↑ cm
30335	26	48



Präsentationsmöglichkeiten
presentation examples

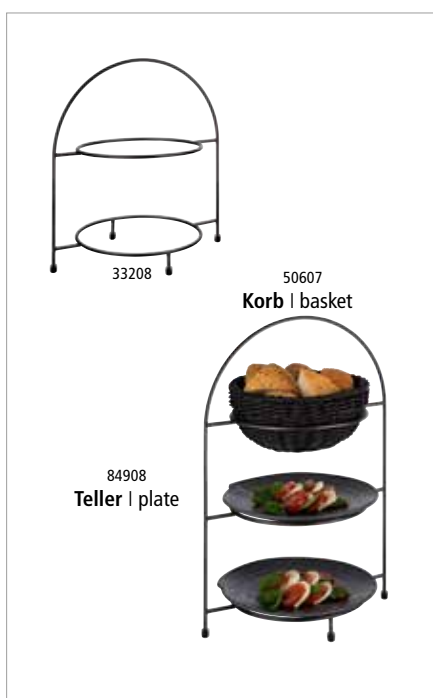

Serviergestell „INDUSTRIAL“

serving stand
soporte platos
présentoir à assiettes

für Teller max. Ø 27 cm, innerer Ring Ø 18 cm, Lieferung ohne Teller

for plates max. Ø 27 cm, circle inside Ø 18 cm, delivery without dishes

para platos máx. Ø 27 cm, aro interior Ø 18 cm, se entrega sin platos

pour assiettes Ø 27 cm maxi., anneau intérieur Ø 18 cm, livré sans assiettes



	cm	↑ cm		passend für Tellerabdeckhauben / suitable for plate covers
33208	29 x 19,5	30	2 Teller Ø 27 cm innerer Ring Ø 18 cm	11051, 11052
33209	29 x 19,5	43	3 Teller Ø 27 cm innerer Ring Ø 18 cm	11051, 11052

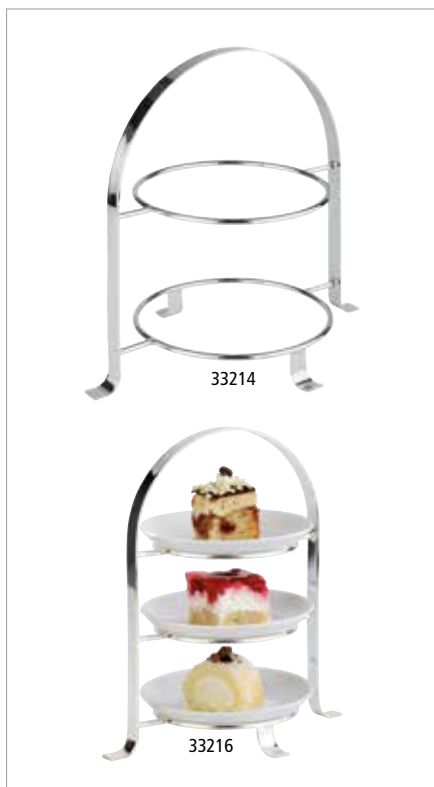

Serviergestell

serving stand
soporte platos
présentoir à assiettes



für 3 Teller max. Ø 27 cm, innerer Ring Ø 18 cm
for 3 plates max. Ø 27 cm, circle inside Ø 18 cm
para 3 platos Ø 27 cm, aro interior Ø 18 cm
pour 3 assiettes maxi Ø 27 cm, anneau intérieur Ø 18 cm

	cm	↑ cm
33217	33 x 24	43

für 2 Teller max. Ø 27 cm, innerer Ring Ø 18 cm, Lieferung ohne Teller
for 2 plates max. Ø 27 cm, circle inside Ø 18 cm, without dishes
para 2 platos Ø 27 cm, aro interior Ø 18 cm, se entrega sin platos
pour 2 assiettes maxi Ø 27 cm, anneau intérieur Ø 18 cm, livré sans assiettes

	cm	↑ cm
33214	33 x 23,5	30

für 3 Teller max. Ø 17 cm, innerer Ring Ø 10,5 cm
for 3 plates max. Ø 17 cm, circle inside Ø 10,5 cm
para 3 platos Ø 17 cm, aro interior Ø 10,5 cm
pour 3 assiettes maxi Ø 17 cm, anneau intérieur Ø 10,5 cm

	cm	↑ cm
33216	22,5 x 16,5	25,5



Serviergestell

serving stand
soporte platos
présentoir à assiettes



für 3 Teller max. Ø 17 cm, innerer Ring Ø 10,5 cm
for 3 plates max. Ø 17 cm, circle inside Ø 10,5 cm
para 3 platos Ø 17 cm, aro interior Ø 10,5 cm
pour 3 assiettes maxi Ø 17 cm, anneau intérieur Ø 10,5 cm

	cm	↑ cm	Farbe / Colour
33215	18,5 x 15,5	26	chrome
33211	18,5 x 15,5	26	copper

für 3 Teller max. Ø 27 cm, innerer Ring Ø 18 cm
for 3 plates max. Ø 27 cm, circle inside Ø 18 cm
para 3 platos Ø 27 cm, aro interior Ø 18 cm
pour 3 assiettes maxi Ø 27 cm, anneau intérieur Ø 18 cm

	cm	↑ cm	Farbe / Colour
33220	29 x 19,5	43	chrome
33212	29 x 19,5	43	copper



Etagère „FINESSE“

etagère
frutero
étagère



vergoldeter Messing-Kugelgriff, einfache Montage
gold plated knob, easy to assemble
botón dorado, fácil de montar
bouton doré, montage facile

	Ø cm	↑ cm	
33248	48 / 38 / 32	50	3-stufig / 3-tier 3 alturas / 3 niveaux
33238	38 / 32	30	2-stufig / 2-tier 2 alturas / 2 niveaux

ETAGERES



Serviergestell, 2-stufig

serving stand, 2-tier
soporte platos, 2 alturas
présentoir, 2 hauteurs

3 tlg. Set: 1 Gestell aus Akazienholz, 2 Schieferplatten, zusammenklappbar

3 pcs.: 1 stand acacia wood, 2 slate trays, foldable

set de 3: 1 soporte madera de acacia, 2 bandejas de pizarra, plegable

set de 3: 1 présentoir en bois d'acacia, 2 plateaux en ardoise naturelle, pliable



zusammenklappbar
foldable

	cm	↑ cm
00958	36,5	34 x 26,5



High Tea Rack

High Tea Rack
rack de té alto
étagère à thé avec anse supérieure

Rubberwood dunkelbraun, Edelstahlgriff, 4 große Fächer 15 x 10 x 10 cm,
3 kleine Fächer 9,5 x 9,5 x 10 cm

rubber wood in dark brown, stainless handle, 4 big compartments 15 x 10 x 10 cm, 3 small compartments 9,5 x 9,5 x 10 cm

madera marrón oscura, mango de acero inoxidable, 4 compartimentos grandes 15 x 10 x 10 cm, 3 compartimentos pequeños 9,5 x 9,5 x 10 cm

bois marron foncé, poignée en acier inox, 4 compartiments grands 15 x 10 x 10 cm, 3 compartiments petits 9,5 x 9,5 x 10 cm



	cm	↑ cm
33210	34 x 10	38



Brezel- oder Wurstständer

pretzel-/ sausage stand
soporte para pretzels/ embutidos
support à bretzel ou à saucissons

Verkaufsständer Buchenholz versiegelt, bestens geeignet für die Präsentation von Brezeln, Würstchen, etc., Fuß Ø 22 cm

beech wood, ideal to present pretzels, sausages, etc., base Ø 22 cm

soporte de madera de haya, ideal para presentar pretzels, salchicas, etc., base Ø 22 cm

support en bois de hêtre, pour la présentation de bretzels, saucisses, etc. pied Ø 22 cm



	Ø cm	↑ cm
79553	28	50

Hygieneschutz für Brezelständer / hygienic cover / campana higiénica antialiento / pare-haleine

	cm	↑ cm
11557	20 x 20 x 20	50
11558	15 x 20 x 15	50



Hobel für Käse und Schokolade

cheese / choco curler
rizador para queso y chocolate
frisette pour fromage et chocolat

3-teilig: Platte Buchenholz versiegelt Ø 22 cm mit senkrechtem Stift

+ Hobel 7 cm + Haube Ø 15 x 10 cm, für Käse und Schokolade

3 pcs.: wooden base Ø 22 cm with vertical bolt + plough 7 cm
+ cover Ø 15 x 10 cm, for cheese and chocolate

set de 3: base de madera Ø 22 cm, con eje vertical de 7 cm

+ campana Ø 15 x 10 cm, para „rizar“ queso y chocolate

set de 3: base bois Ø 22 cm, axe vertical ht. 7 cm, cloche Ø 15 x ht 10 cm,

pour „friser“ le fromage ou le chocolat



	Ø cm	↑ cm
50002	22	15



3-stufige Etagère

3-tier tray
bandeja con tres alturas
étagère carré 3 hauteurs

Naturschieferplatte, Akazienholz

natural slate tray, wood akazie
bandeja de pizarra natural, madera de acacia
plateau ardoise naturelle, bois d'acacia



	∅ cm	↑ cm	* mm
00960	30 / 25 / 20	34	6 - 9

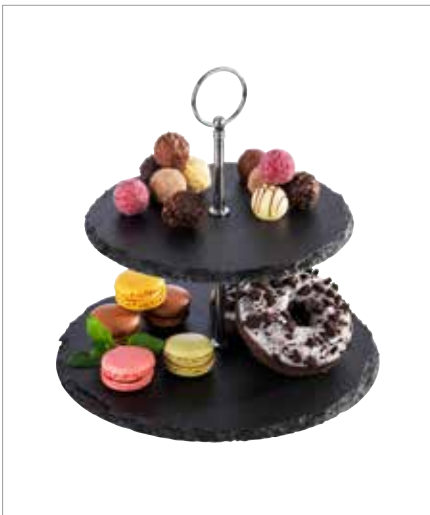

2-stufige Etagère

2-tier tray
bandeja dos alturas
étagère carré 2 hauteurs

Naturschiefer

natural slate tray
bandeja de pizarra natural
plateau ardoise naturelle



	∅ cm	↑ cm	* mm
00989	25 / 20	24	6 - 9

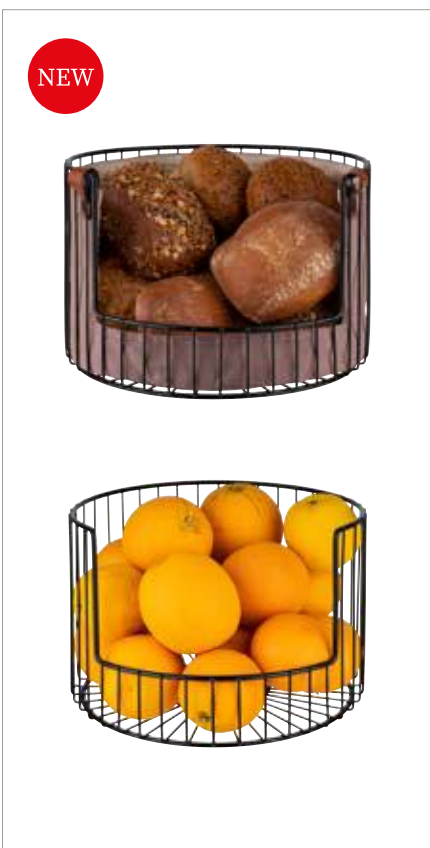

Brot- und Obstkorb

basket for bread or fruits
cesta para pan o fruta
corbeille à pain ou à fruits



inklusive Tasche aus Baumwolle, beige grau, maschinenwaschbar bis 30 Grad

incl. bag made of cotton, beige, grey, machine washable up to 30°C
bolsa incluida, de algodón, beige, gris, lavable a máquina hasta 30°C
sac inclus en coton, beige, gris, lavable en machine jusqu'à 30°C

	∅ cm	↑ cm
30209	27,5	18,5



stapelbar
stackable

rutschfest inklusive Klipp
non-slip, includes clip

ETAGERES

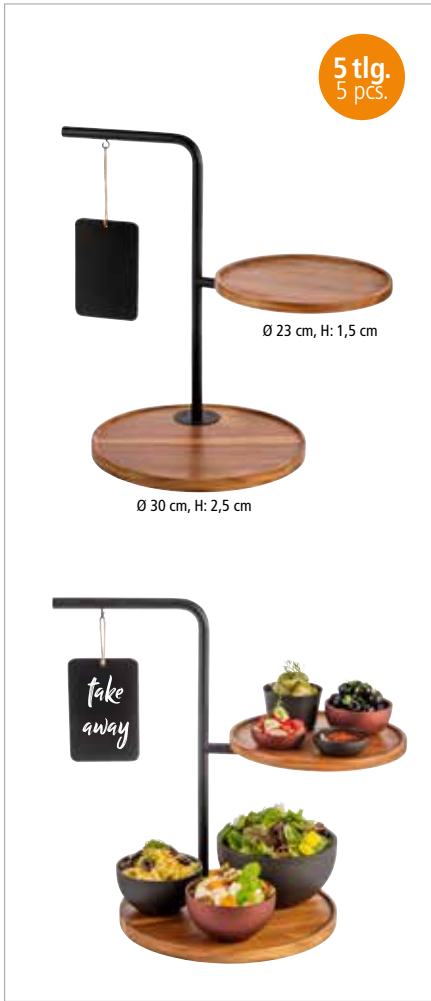

2-stufige Etagère „IRON“

2-tier tray
bandeja con dos alturas
étagère carré 2 hauteurs

- 1 Gestell aus schwarzem Metall
- 2 Akazienholzplatten: Ø 23 cm, H: 1,5 cm / Ø 30 cm, H: 2,5 cm
- 2 Beschriftungsschilder 15 x 10,5 cm

- 1 soporte metálico negro
- 2 tablas de madera de acacia: Ø 23 cm, H: 1,5 cm / Ø 30 cm, H: 2,5 cm
- 2 etiquetas de inscripción 15 x 10,5 cm

- 1 support métallique noir
- 2 panneaux en bois d'acacia: Ø 23 cm, H: 1,5 cm / Ø 30 cm, H: 2,5 cm
- 2 étiquettes d'inscription 15 x 10,5 cm



	cm	↑ cm
30334	47 x 30	44

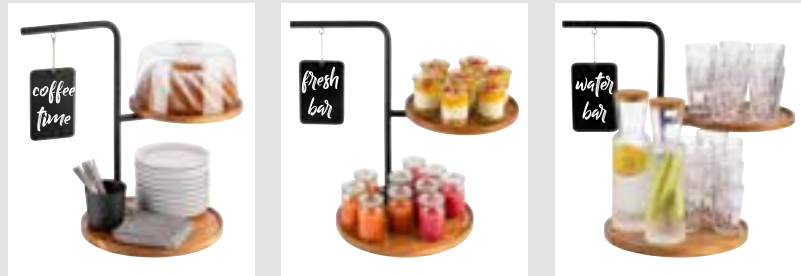

Präsentationsmöglichkeiten
presentation examples



2-stufige Etagère

2-tier tray
soporte 2 alturas
étagère 2 niveaux

- 1 Gestell aus Metall schwarz, mit Antirutschfüßchen,
- 2 herausnehmbare Bretter aus geöltem Akazienholz (34,5 x 20,5 x 1,5 cm) / (34,5 x 13 x 1,5 cm)
- 8 Beschriftungsschilder (8 x 4 cm)

- 1 frame made of black metal with non-slip feet,
- 2 removable trays made of acacia wood (34,5 x 20,5 x 1,5 cm) / (34,5 x 13 x 1,5 cm)
- 8 labelling plates (8 x 4 cm)

- 1 soporte metálico, negro con pies antideslizantes,
- 2 bandejas extraíbles de madera de acacia (34,5 x 20,5 x 1,5 cm) / (34,5 x 13 x 1,5 cm)
- 8 etiquetas (8 x 4 cm)

- 1 support métallique noir avec pieds antidérapants,
- 2 planches amovibles en bois d'acacia (34,5 x 20,5 x 1,5 cm) / (34,5 x 13 x 1,5 cm)
- 8 étiquettes (8 x 4 cm)



	cm	↑ cm
30339	35,5 x 21	40



Präsentationsmöglichkeiten
presentation examples



mit Antirutschfüßchen
with non-slip feet

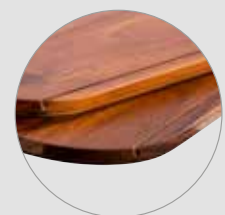

geöltes Akazienholz
oiled acacia wood



1 x Gestell / 1 x frame



2 x Korb / 2 x basket

5 tlg.
5 pcs.



2 x Tablett / 2 x tray



Haube / cover 11056



Korb / basket 30337



Tablett / tray 85099



Tablett / tray 30338

2-stufige Etagère „ALL-ROUNDER“, 5-teilig

2-tier tray, 5 pcs.

soporte 2 alturas, set de 5

étagère 2 niveaux, set de 5

5 teiliges Set:

- 1 Gestell aus Metall schwarz, mit Antirutschfüßchen,
- 2 Körbe aus Metall schwarz je 29 x 16 cm, H: 7 cm,
- 2 herausnehmbare Bretter aus geöltem Akazienholz je 28,5 x 15,5 cm, H: 1,5 cm

5 pcs.:

- 1 frame made of black metal with non-slip feet,
- 2 removable baskets of black metal each 29 x 16 cm, H: 7 cm,
- 2 boards of oiled acacia wood each 28,5 x 15,5 cm, H: 1,5 cm

set de 5:

- 1 soporte metálico, negro con pies antideslizantes,
- 2 cestas metálicas negras, cada una de 29 x 16 cm, H: 7 cm,
- 2 tablas de madera de acacia aceiteada 28,5 x 15,5 cm, H: 1,5 cm

set de 5:

- 1 support métallique noir avec pieds antidérapants,
- 2 paniers métalliques noirs, chacune 29 x 16 cm, H: 7 cm,
- 2 planches d'acacia huilé, chacune 28,5 x 15,5 cm, H: 1,5 cm



	cm	↑ cm
30336	31 x 17	37,5



multifunktional,
ideal als

- Frühstücks-Etagère
- Vorspeisen-Etagère
- Kuchen-Etagère
- Brot-Etagère
- Gebäck-Etagère
- Früchte-Etagère

Präsentationsmöglichkeiten
presentation examples



geöltes Akazienholz
oiled acacia wood



mit Antirutschfüßchen
with non-slip feet

Korb / basket / cesta / corbeille

	cm	↑ cm	Farbe / Colour
30337	29 x 16	7	■

Servierbrett aus Akazienholz / serving board of acacia wood / tabla de servir de madera de acacia / planche de service en bois d'acacia

	cm	↑ cm	Farbe / Colour
30338	28,5 x 15,5	3,5	■

Melamintablett / melamine tray / bandeja de melamina / plateau en mélamine

	cm	↑ cm	Farbe / Colour
85099	28,0 x 15,5	1,0	■

Haube / cover / campana / cloche

	cm	↑ cm
11056	26,0 x 12,0	10,0

ETAGERES



Etagère, 2-stufig

2-tier tray
bandeja 2 alturas
étagère carré 2 hauteurs

Gestell aus Eichenholz (geölt)

oak wood frame (oiled)
marco de madera de roble (aceitada)
structure en bois du chêne (huilé)



	cm	↑ cm	fits to
14010	35 x 26,5	44,5	GN 1/2, 1/3
14011	55,5 x 26,5	44,5	GN 2/4

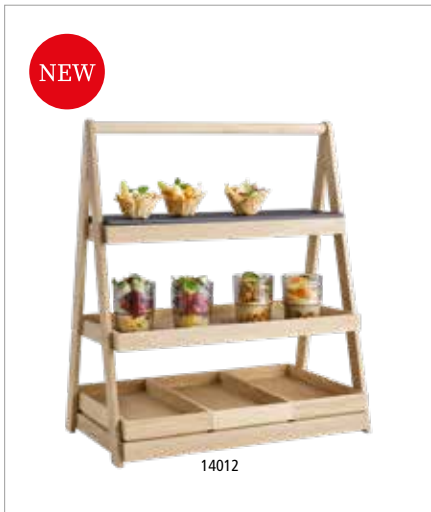

Etagère, 3-stufig

3-tier tray
bandeja 3 alturas
étagère carré 3 hauteurs

Gestell aus Eichenholz (geölt)

oak wood frame (oiled)
marco de madera de roble (aceitada)
structure en bois du chêne (huilé)



	cm	↑ cm	fits to
14012	55,5 x 32,5	64	GN 1/1, 2/4



Etagère, 2+3-stufig, rund

2+3-tier tray, round
bandeja 2+3 alturas, en torno a
étagère carré 2+3 hauteurs, rond

Gestell aus Eichenholz (geölt)

oak wood frame (oiled)
marco de madera de roble (aceitada)
structure en bois du chêne (huilé)



	Ø cm	↑ cm
14013	30	28
14014	30	42

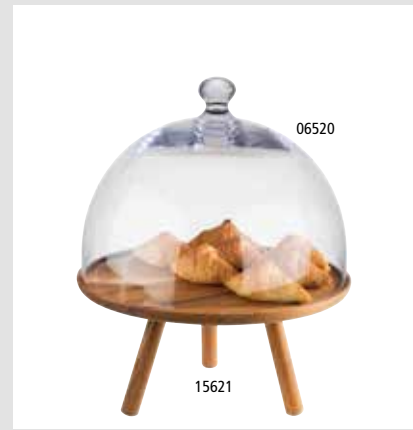

Buffetständer „ACACIA“

buffet stand
soporte para buffet
présentoir buffet

Akazienholz geölt / acacia wood oiled / madera de acacia aceitada / bois d'acacia huilé



	Ø cm	↑ cm
15620	20,0	10,5
15621	30,5	15,0
15622	30,5	20,0

Frischhaltehaube / cover / campana / cloche



	Ø cm	↑ cm	fits to
06520	30	22	15621, 15622

Frischhaltehaube / cover / campana / cloche



	Ø cm	↑ cm	fits to
06512	30	11,5	15621, 15622



Buffetständer „ACACIA“

buffet stand
soporte para buffet
présentoir buffet

Akazienholz geölt / acacia wood oiled / madera de acacia aceitada / bois d'acacia huilé



	cm	↑ cm	GN
15623	53 x 16,2	20	2/4



GN Abdeckhaube / GN cover / GN campana/ GN cloche

	cm	↑ cm	GN
11044	53 x 16,2	10,5	2/4

CUTTING BOARDS



00954
Box

00953
Schneidebrett

83615
Tablett



Tablett „BROTSTATION“

tray
bandeja
plateau

mit Antirutschfüßchen
with non-slip feet
con pies antideslizantes
avec pieds antidérapants



	cm	↑ cm
83615	59,5 x 35,5	3,5

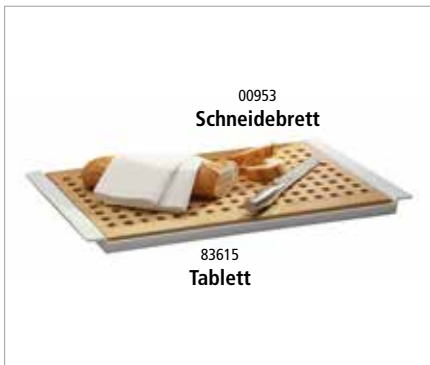

00953
Schneidebrett

83615
Tablett

Brotschneidebrett „BROTSTATION“

cutting board
tabla de corte
planche à découper

Buchenholz
beech
haya
hêtre



	cm	↑ cm
00953	52 x 34	2

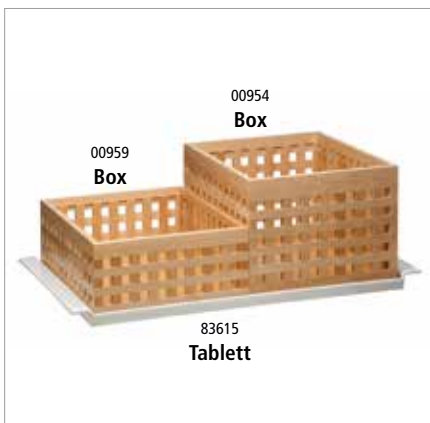

00959
Box

83615
Tablett

Box „BROTSTATION“

box
caja de pan
boîte à pain

Buchenholz
beech
haya
hêtre



	cm	↑ cm
00959	34 x 26	12,5
00954	34 x 26	20,0



Brotschneidebrett „PROFI“

cutting board
tabla de cortar
planche à découper



Eichenholz / oak wood / mader de roble / bois de chêne

	cm	↑ cm	
00806	58 x 37,5	4	



Brotschneidebrett

cutting board
tabla de cortar
planche à découper



Walnussholz / walnut wood / mader de nogal / bois de noyer

	cm	↑ cm	GN
00911	35,4 x 32,5	3,5	2/3



praktisches Krümfach
practical crump shelf



praktisches Krümfach
practical crump shelf

Brotschneidebrett „LETTER“

cutting board
tabla de cortar
planche à découper



Akazienholz / acacia wood / mader de acacia / bois d'acacia

	cm	↑ cm	
00886	48 x 34	3,5	



00885

Brotschneidebrett

cutting board
tabla de cortar
planche à découper



Akazienholz / acacia wood / mader de acacia / bois d'acacia

	cm	↑ cm	GN
00883	47,5 x 32,0	2	
00884	53,0 x 32,5	2	1/1
00885	60,0 x 40,0	2	



praktisches Krümfach
practical crump shelf



00957

Brotschneidebrett

cutting board
tabla de cortar
planche à découper



Rubberwood / rubberwood / mader de caucho / bois d'hévéa

	cm	↑ cm	GN
00955	47,5 x 32,0	2	
00956	53,0 x 32,5	2	1/1
00957	60,0 x 40,0	2	



praktisches Krümfach
practical crump shelf



CUTTING BOARDS



Schneidebrett

cutting board
tabla de cortar
planche à découper

Eichenholz, geölt, mit Antirutsch-Füßchen

oak wood oiled, with non-slip feet
madera de roble aceitada, con pies antideslizantes
bois de chêne huilé, avec pieds antidérapants



	cm	↑ cm	Farbe / Colour
00762	58,5 x 35	2	

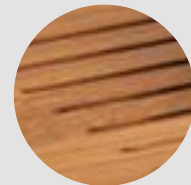

Eichenholz
oak wood

Präsentationsmöglichkeit / presentation example



Schneidebrett

cutting board
tabla de cortar
planche à découper

Walnuss, geölt, mit Antirutsch-Füßchen

walnut wood oiled, with non-slip feet
madera de nogal aceitada, con pies antideslizantes
bois noyer huilé, avec pieds antidérapants



	cm	↑ cm	Farbe / Colour
00763	58,5 x 35	2	

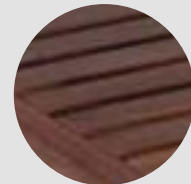

Walnuss
walnut wood

Präsentationsmöglichkeit / presentation example



Tablett / Basis

tray / base
bandeja / base
plateaux / base

Melamin, schwarz, mit Antirutsch-Füßchen, passendes Schneidebrett Nr. 762, 763

melamine, black, with non-slip feet, suitable cutting board art. 762, 763

melamina, negro, con pies antideslizantes, tabla de cortar adecuada art. 762, 763

mélamine, noir, avec pieds antidérapants, planche à découper appropriées art. 762, 763



	cm	↑ cm
85225	67 x 38	4



Dressingtopf / Flaschenkühler „FROSTFIRE“

dressing pot / bottle cooler
salsera / enfriador de botella
pot à sauce / rafraîchisseur



Antihafbeschichtung / non stick coating / antiadherente / revêtement anti-adhésif

	Ø cm	↑ cm	ltr.	Farbe / Colour
36140	11,5 / 11	15	1,5	black/silver



auch als Flaschenkühler verwendbar
also usable as a bottle cooler



Dressingtopf-Display / -Station

wooden station for 3 dressing pots
expositor de madera para 3 salseras
présentoir en bois pour 3 pots à sauce



inklusive 3 Beschriftungsschilder aus Metall / including 3 metal labels / con 3 etiquetas de metal / avec 3 étiquettes métalliques

	cm	↑ cm	fits to
84863	40 x 16	9	83311, 83867



Dressingtopf „PASTELL“

dressing pot
salsera
pot à sauce



	cm	↑ cm	ltr.	Farbe / Colour
84862	13	19,5	1,5	green
84860	13	19,5	1,5	white

Beschriftungsetiketten, 72 Stück / labeling labels, 72 pcs. / etiquetas, 72 pzs / étiquettes, 72 pcs.

	cm	Farbe / Colour
00069	8 x 4,6	black



mit Antirutschfüßchen
with non-slip feet



stapelbar
stackable



Dressingtopf „CASUAL“

dressing pot
salsera
pot à sauce



	cm	↑ cm	ltr.	Farbe / Colour
83867	12	21,5	1	white
83868	12	21,5	1	black



Dressingtopf

dressing pot
salsera
pot à sauce



Deckel mit Löffelaussparung / cover notched for spoon / tapa agujereada para el cucharón / couvercle avec espace pour la louche

	Ø cm	↑ cm	ltr.
83310	17,0	15	2,0
83311	13,0	13	0,8

SQUARE



GN 1/1 Buffetbrett „SQUARE“

GN 1/1 buffet board
GN 1/1 tabla de buffet
GN 1/1 planche de buffet

aus geöltem Eichenholz
made of oiled oak wood
de madera de roble aceitada
en bois de chêne huilé



	cm	↑ cm	GN
00758	53,0 x 32,5	2,5	1/1

passende Haube / suitable cover / campana adecuada / cloche appropriée

	cm	↑ cm	GN
11075	53,0 x 32,5	19	1/1



Haube fixiert sich auf dem Brett, rutschfest
cover fixes itself on the board, non-slip



GN 1/2 Buffetbrett „SQUARE“

GN 1/2 buffet board
GN 1/2 tabla de buffet
GN 1/2 planche de buffet

aus geöltem Eichenholz
made of oiled oak wood
de madera de roble aceitada
en bois de chêne huilé



	cm	↑ cm	GN
00759	32,5 x 26,5	2,5	1/2

passende Haube / suitable cover / campana adecuada / cloche appropriée

	cm	↑ cm	GN
11073	33 x 28	17	1/2



Haube fixiert sich auf dem Brett, rutschfest
cover fixes itself on the board, non-slip

**GN 2/4 Buffetbrett „SQUARE“**

GN 2/4 buffet board
GN 2/4 tabla de buffet
GN 2/4 planche de buffet

aus geöltem Eichenholz

made of oiled oak wood
de madera de roble aceitada
en bois de chêne huilé



	cm	↑ cm	GN
00760	53,0 x 16,2	2,5	2/4

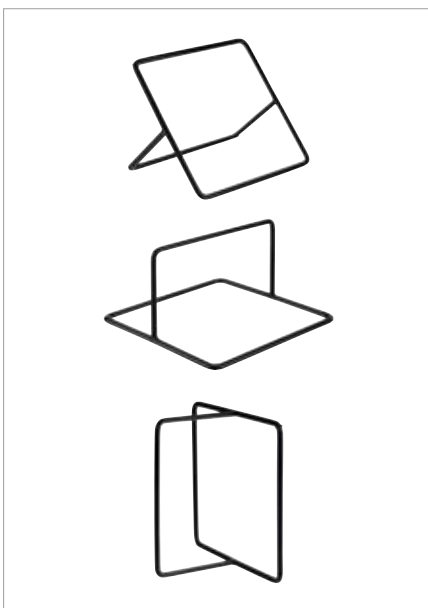

Präsentationsmöglichkeit
presentation example

**Buffetständer „SQUARE“**

buffet stand
soporte para buffet
présentoir buffet

Metall, mit schwarzer Antirutschbeschichtung

metal, with black anti-slide coating
metal, con revestimiento antideslizante negro
métal, avec revêtement antidérapant noir



	cm	↑ cm
33305	12 x 12	7



Präsentationsmöglichkeit | presentation example

**Buffetbrett**

buffet board
tabla de buffet
planche de buffet

für Karaffen, mit 3 Einsätzen Ø 11 cm aus Kunstleder, aus geöltem Eichenholz

for carafes, with 3 leatherette inserts Ø 11 cm, made of oiled oak wood
para jarras, con 3 inserciones de imitación de cuero Ø 11 cm, de madera de roble aceitada
pour pichets, avec 3 inserts en similicuir Ø 11 cm, en bois de chêne huilé



	cm	↑ cm	Farbe / Colour
11705	47 x 19	2	natural oak
11706	47 x 19	2	dark oak

passende Karaffe / suitable carafe / jarra a juego / pichet approprié

	Ø cm	↑ cm	ltr.
10690	9,5	31	1,0

6 Einsätze aus Kunstleder / 6 leatherette inserts / 6 inserciones de imitación de cuero / 6 inserts en similicuir

	Ø cm	Farbe / Colour	pcs.
35716	11	anthracite	6



Kunstledereinsatz herausnehmbar
removable leatherette insert

BUFFET BOARDS „PROFI“



Buffetbrett „PROFI“ buffet board tabla de buffet planche de buffet

aus geöltem Eichenholz, Safrinne, mit Antirutschfüßchen

made of oiled oak, with juice groove and non-slip feet

de madera de roble aceitada, con ranura para líquidos y pies antideslizantes

en bois chêne huilé, avec rigole et pieds antidérapants



	Ø cm	↑ cm
00805	33	4,5
00816	39	4,5

Frischhaltehaube / cover / campana / cloche



	Ø cm	↑ cm	fits to
06512	30	11,5	00805

Frischhaltehaube / cover / campana / cloche



	Ø cm	↑ cm	fits to
06519	21	17	00815
06520	30	22	00805
06521	36	27	00816



Buffetbrett „PROFI“ buffet board tabla de buffet planche de buffet

aus geöltem Eichenholz, Safrinne, mit Antirutschfüßchen

made of oiled oak, with juice groove and non-slip feet

de madera de roble aceitada, con ranura para líquidos y pies antideslizantes

en bois chêne huilé, avec rigole et pieds antidérapants



	cm	↑ cm
00807	38 x 32,0	4,5
00806	58 x 37,5	4,5

Rolltophaube / rolltop cover / campana rolltop / cloche rolltop



	Ø cm	↑ cm	fits to	GN
11016	53,0 x 32,5	19	00806	1/1



Multi Rack
multi rack
dispensador en escalera
support multiple



- 1 Gestell schwarz, matt
- Schütten aus grau gefroretem Kunststoff, je ca. 1 Liter
- 1 frame matt
- bowls frosted plastic, approx. 1 liter
- 1 soporte mate
- cuencos de plástico glaseado, aprox. 1 litro
- 1 support mat
- bols en plastique mat, approx. 1 litre

	cm	↑ cm	ltr.
11413	19 x 24	41	1
11414	19 x 31	53	1

Ergänzung für alle Multi-Racks
supplement for all multi racks
suplemento para todos los dispensadores
compléments pour support multi-rack



Schütte / canister / cuenco / bol

	cm	↑ cm	ltr.
11411	19,5 x 16,5	10,5	1



Multi Rack
multi rack
dispensador en escalera
support multiple



- 1 Gestell matt poliert
- Schütten aus transparent gefroretem Kunststoff, je ca. 1 Liter
- 1 frame matt polished
- bowls frosted plastic, approx. 1 liter
- 1 soporte pulido mate
- cuencos de plástico glaseado, aprox. 1 litro
- 1 support poli mat
- bols en plastique mat, approx. 1 litre

	cm	↑ cm	
11444	19 x 24	41	
11446	19 x 31	53	

Ergänzung für alle Multi-Racks
supplement for all multi racks
suplemento para todos los dispensadores
compléments pour support multi-rack



Schütte / canister / cuenco / bol

	cm	↑ cm	ltr.
11455	19,5 x 16,5	10,5	1,0

JARS



82255 1,0 ltr.



82256 2,0 ltr.



82257 2,5 ltr.

Vorratsglas „WOODY“

jar with lid
bote con tapa
pot en verre avec couvercle



Glasbehälter mit Holzdeckel, aromadichter Verschluss

glass container, aroma-tight screw cap

recipiente de cristal, tapa con cierre hermético para conservar el aroma

réceptien en verre, couvercle avec fermeture hermétique pour conserver l'arôme

	cm	↑ cm	ltr.
82255	14 x 14	11,0	1,0
82256	14 x 14	17,0	2,0
82257	14 x 14	21,5	2,5



Holzdeckel aus Kiefernholz mit Silikondichtung
wooden lid from pine wood with silicone gasket



82265 1 ltr.

82266 1,2 ltr.



82267 1,5 ltr.

Vorratsglas

jar with lid
bote con tapa
pot en verre avec couvercle



inklusive Glasdeckel mit Dichtung und Beschriftungsfeld, somit bleibt Ihre Ware frisch

including glass lid with seal and labeling field, thus, your goods remain fresh

con tapa de vidrio con junta y campo de etiquetado, por lo tanto, sus productos permanecen frescos

y compris couvercle en verre avec joint et le domaine de l'étiquetage, ainsi, vos marchandises restent fraîches

	Ø cm	↑ cm	ltr.
82265	11,0	18,0	1,0
82266	11,5	19,5	1,2
82267	12,0	21,0	1,5



71490

Kreidestift zum Beschriften | chalk marker for writing
S. 346



82250 0,9 ltr.



82251 2 ltr.



82252 4 ltr.



82253 6 ltr.

Vorratsglas „CLASSIC“

jar with lid
bote con tapa
pot en verre avec couvercle

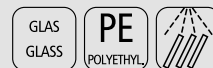

inklusive Glasdeckel mit Dichtung, somit bleibt Ihre Ware frisch

including glass lid with seal, thus, your goods remain fresh

con tapa de vidrio con junta, por lo tanto, sus productos permanecen frescos

y compris couvercle en verre avec joint, ainsi, vos marchandises restent fraîches

	Ø cm	↑ cm	ltr.
82250	11,5	16,0	0,9
82251	14,0	21,5	2,0
82252	18,0	26,0	4,0
82253	20,0	30,0	6,0



Präsentationsmöglichkeit
presentation example



2 ltr.

Vorratsglas mit luftdichtem Klappdeckel

jar with airtight cover
bote con cierre hermético
pot en verre avec fermeture hermétique



	cm	↑ cm	ltr.
82328	12 x 12	22	2



seitlich gestellt
placed sideways
1 ltr.



hochkant gestellt
placed upright
2,2 ltr.



Vorratsglas
jar with lid
bote con tapa
pot en verre avec couvercle



mit Löffel, Schraubdeckel mit aromadichtem Verschluss, Edelstahlöffel mit magnetischem Silikongriff
tight cover, stainless steel spoon with magnetic silicone handle
tapa a rosca con cierre hermético, cuchara de acero inoxidable con mango de silicona magnético
couvercle à vis avec fermeture hermétique, cuillère en acier inox avec manche de silicone aimanté

	cm	↑ cm	ltr.
00636	17 x 12,5	18	1 - 2,2

seitlich gestellt
placed sideways
1 ltr.



hochkant gestellt
placed upright
2,2 ltr.

Vorratsglas
jar with lid
bote con tapa
pot en verre avec couvercle



mit Schraubdeckel, aromadichtem Verschluss
aroma-tight screw cap
tapa a rosca para conservar el aroma
couvercle à vis pour conserver l'arôme

	cm	↑ cm	ltr.
00637	17 x 12,5	18	1 - 2,2

stapelbar
stackable

Frontklappe
front lid



11884

11885

Universalbox
box / sweetbox
caja dispensadora
boîte distributrice



ideal als Verkaufsbox, mit Frontdeckel
best to present sweets etc., all-purpose, with front lid
la perfecta solución para presentar golosinas, universal, con tapa frontal
la solution idéale pour les friandises et autres, universal, avec couvercle frontal

	cm	↑ cm	Farbe / Colour
11884	23 x 14,5	15	White
11885	23 x 14,5	15	Red



Schale, 3er Set „SPHERE“

bowl, 3 pcs.
cuenco, set de 3
bol, set of 3



innen: mattiert / inside: matt / interior: mate / intérieur: mat

	Ø cm	↑ cm	ltr.	Farbe / Colour	pcs.
40770	8	7	0,1	gold	3
40771	8	7	0,1	copper	3
40772	8	7	0,1	gunmetal	3



Schale „SPHERE“

bowl
cuenco
bol



innen: mattiert / inside: matt / interior: mate / intérieur: mat

	Ø cm	↑ cm	ltr.	Farbe / Colour
40773	16	15	0,8	gold
40774	16	15	0,8	gunmetal



Schale „SPHERE“

bowl
cuenco
bol



innen: mattiert / inside: matt / interior: mate / intérieur: mat

	Ø cm	↑ cm	ltr.	Farbe / Colour
40775	24	21	2	gold
40776	24	21	2	gunmetal



5 STARS



Töpfe aus emailliertem Gusseisen leiten nicht nur die Wärme gut, sondern können sie auch lange energieschonend speichern – ideal für den professionellen Einsatz am Buffet!

Cooking pots made of enamelled cast iron not only conduct heat well, but can also store it for a long time while conserving energy - ideal for professional use at the buffet!

Las ollas de hierro fundido esmaltado no sólo conducen bien el calor, sino que también pueden almacenarlo durante mucho tiempo conservando la energía: ¡ideales para un uso profesional en el buffet!

Les marmites en fonte émaillée ne conduisent pas seulement bien la chaleur, mais peuvent aussi la conserver longtemps en économisant de l'énergie - idéal pour une utilisation professionnelle au buffet!



88300 2,5 ltr.



88301 2,5 ltr.



88312 2,5 ltr.

Bräter mit Deckel „5 STARS“

roaster with lid
cacerola con tapa
cocotte avec couvercle



	Ø cm	↑ cm	ltr.	Farbe / Colour
88300	25	7 / 13	2,5	
88301	25	7 / 13	2,5	
88312	25	7 / 13	2,5	



88300

inklusive Deckelhalter
including lid holder

NEW



88302 4 ltr.



88303 4 ltr.



88313 4 ltr.

Kochtopf mit Deckel „5 STARS“
 cooking pot with lid
 olla con tapa
 marmite avec couvercle



	Ø cm	↑ cm	ltr.	Farbe / Colour
88302	25	11,5 / 17,5	4	
88303	25	11,5 / 17,5	4	
88313	25	11,5 / 17,5	4	



88302

inklusive Deckelhalter
 including lid holder

NEW



88304 3 ltr.



88305 3 ltr.



88314 3 ltr.

Bräter mit Deckel „5 STARS“
 roaster with lid
 cacerola con tapa
 cocotte avec couvercle



	Ø cm	↑ cm	ltr.	Farbe / Colour
88304	28	7 / 13,5	3	
88305	28	7 / 13,5	3	
88314	28	7 / 13,5	3	



88304

inklusive Deckelhalter
 including lid holder



Kochtopf mit Deckel „5 STARS“

cooking pot with lid
olla con tapa
marmite avec couvercle



	Ø cm	↑ cm	ltr.	Farbe / Colour
88306	28	13 / 20	6	
88307	28	13 / 20	6	
88315	28	13 / 20	6	



inklusive Deckelhalter
including lid holder



Bräter mit Deckel „5 STARS“

roaster with lid
cacerola con tapa
cocotte avec couvercle



	cm	↑ cm	ltr.	Farbe / Colour
88308	33 x 25	11 / 17,5	5	
88309	33 x 25	11 / 17,5	5	
88316	33 x 25	11 / 17,5	5	



inklusive Deckelhalter
including lid holder



Auflaufform „5 STARS“
casserole dish
fuente para gratinar
plat à four



	cm	↑ cm	ltr.	Farbe / Colour
88310	33 x 24	6,5	3,5	Red
88311	33 x 24	6,5	3,5	Black
88317	33 x 24	6,5	3,5	Teal



Deckelhalter, 2er Set
lid holder, 2 pcs.



soporte para tapa, set de 2
support de couvercle, set de 2

mit Antirutschbeschichtung, für alle Töpfe mit Deckel einsetzbar, hitzebeständig
with non-slip coating, suitable for all pots with lids, heat-resistant

revestimiento antideslizante, apto para todas las ollas con tapa, resistente al calor
avec revêtement antidérapant, adapté à toutes les casseroles avec couvercle, résistant à la chaleur

	cm	↑ cm	Farbe / Colour	pcs.
88320	10,5 x 8,5	3,5	Black	2



CHAFING DISH

4 tlg.
4 pcs.



12330



12335



12336



12337



12338



12339



82211

Chafing Dish, 4-teiliges Set

chafing dish set, 4 pcs.
chafing dish, set de 4
chafing dish, set de 4



4-teiliges Set:

- 1 Topf (8 Liter)
- 1 Speisenbehälter (4 Liter)
- 1 Deckel mit Sichtfenster und 1 Deckelbremse
- Topf mit induktionsfähigem Sandwich- / Kapselboden

4 pcs. set:

- 1 pot (8 litres),
- 1 foodpan (4 litres)
- 1 lid with glass insert and 1 automatic lid brake
- pot with induction-compatible sandwich base

set de 4:

- 1 olla (8 litros)
- 1 cubeta (4 litros)
- 1 tapa con ventanilla y 1 sistema de freno en la tapa
- olla con base sandwich apta para inducción

set de 4:

- 1 casserole (8 litres)
- 1 bac (4 litres)
- 1 couvercle avec fenêtre et 1 système de frein dans le couvercle
- casserole avec fond sandwich pour induction

	Ø cm	↑ cm	ltr.	Farbe / Colour	
12330	30,5	17,5	4		stainless
12335	30,5	17,5	4		copper
12336	30,5	17,5	4		yellow
12337	30,5	17,5	4		red
12338	30,5	17,5	4		black
12339	30,5	17,5	4		green

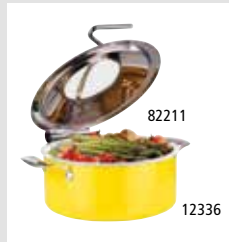

82211

12336



abnehmbarer Deckel
removable lid

induktionsgeeignet
suitable for induction

Ersatz-Speisenbehälter zu Chafing Dish / replacement foodpan for chafing dish / cubeta interior de repuesto para chafing dish / bac intérieur de remplacement pour le chafing dish

	Ø cm	↑ cm	ltr.	fits to
12329	30,5	8	4	12330, 12335, 12336, 12337, 12338, 12339



Ø 33 cm



Sandwich- / Kapsel-
boden / sandwich base



12329

Ø 30,5 cm

4 ltr. Speisenbehälter
4 ltr. foodpan



Deckelbremse
automatic lid break

Porzellaneinsatz

porcelain insert
bandeja de porcelana
bac en porcelaine



	Ø cm	↑ cm	ltr.	fits to
82211	29,5	9	3	12330, 12335, 12336, 12337, 12338, 12339



Die Induktionsstation mit Regler präsentiert sich in einem Set aus Eiche, einem schwarzen Metallständer und einer Induktionsheizung.

The induction station with controller is presented in a set of oak, a black metal stand and an induction heater.

La estación de inducción con regulador se presenta en un set formado por una caja de madera de roble, un soporte de metal negro y un calentador de inducción.

La station à induction avec température réglable se compose d'un caisson en bois de chêne, d'un support métallique noir et d'une plaque à induction.

NEW

4 tlg.
4 pcs.

Kochplatte Ø 24 cm
induction station Ø 24 cm



12276



12272



12295



15506

Induktionsstation, 4-tlg. Set

induction station, 4 pcs.
estación de inducción, set de 4
station d'induction, set de 4

4 teiliges Set:

- 1 Induktionskochplatte mit Regler (Ø 24 cm, 900 Watt)
- 1 Metallständer schwarz
- 1 Rahmen aus Eiche (wasserfest lackiert)
- 1 Edelstahlrahmen

4 pcs. set:

- 1 induction hotplate with controller (Ø 24 cm, 900 watt)
- 1 metal stand black
- 1 frame made of oak (water-resistant coated)
- 1 stainless steel frame

set de 4:

- 1 placa de inducción con regulador (Ø 24 cm, 900 vatios)
- 1 soporte de metal negro
- 1 caja de roble (con recubrimiento resistente al agua)
- 1 marco de acero inoxidable

set de 4:

- 1 plaque d'induction avec température réglable (Ø 24 cm, 900 watts)
- 1 support métallique noir
- 1 cadre en chêne (verni résistant à l'eau)
- 1 cadre en acier inox



	cm	↑ cm
12275	35,4 x 32,5	19



passendes Chafing Dish Set 12339
suitable chafing dish set 12339

Ersatzteile / replacement parts / piezas de repuesto / pièces de rechange

	cm	↑ cm	
12276	35,4 x 32,5	8,5	Holzrahmen / wooden frame
12272	29,5 x 26,5	1	Edelstahlrahmen / stainless steel frame
12295	Ø 24	-	900 Watt Induktionskochplatte / induction plate
15506	35,4 x 32,5	17,6	Buffetständer schwarz / buffet stand black

NAPKIN HOLDERS



Serviettenhalter

napkin holder
servilletero
porte-serviettes



hochglanzpoliert, für Servietten mit 1/8 Falz, FüÙe mit rutsch- und kratzfester Gummierung
mirror polished, for napkins with 1/8 fold, feet with non-slip and scratch-resistant rubber coating

pulido brillante, para servilletas plegado 1/8, pies con revestimiento de goma antideslizante y anti rayaduras

poli brillant, pour serviettes pliage 1/8, pieds avec caoutchouc antidérapant et antirayures

	cm	↑ cm
11720	10 x 11,5	18,5



11767

11768

Serviettenhalter „HERO“

napkin holder
servilletero
porte-serviettes



für ca. 65 Cocktailservietten, inklusive Beschwerer

for approx. 65 cocktail napkins, including weight

para aprox. 65 servilletas cocktail, con barra de contrepeso

pour environ 65 serviettes cocktail, avec barre de contrepoids

	cm	↑ cm
11767	14,5 x 14,5	10

für ca. 95 Servietten 1/4 Falz, inklusive Beschwerer

for approx. 95 napkins 1/4 fold, including weight

para aprox. 95 servilletas de plegado ¼, con barra de contrepeso

pour environ 95 serviettes pliage ¼, avec barre de contrepoids

	cm	↑ cm
11768	18,5 x 18,5	14



inklusive Beschwerer
including weight



11770



11771

Serviettenhalter „URBAN“

napkin holder
servilletero
porte-serviettes



für ca. 50 Servietten ¼ Falz, inklusive Beschwerer

for approx. 50 napkins ¼ fold, including weight
para aprox. 50 servilletas de plegado ¼, con barrita de contrapeso
pour environ 50 serviettes pliage ¼, avec barre de contrepoids

	cm	↑ cm
11770	19 x 19	7,5

für ca. 120 Servietten ¼ Falz, inklusive Beschwerer

for approx. 120 napkins ¼ fold, including weight
para aprox. 120 servilletas de plegado ¼, con barrita de contrapeso
pour environ 120 serviettes pliage ¼, incl. barrie de contrepoids

	cm	↑ cm
11771	19 x 19	18



inklusive Beschwerer
including weight



11762



11763



11765

Serviettenhalter „WIRE“

napkin holder
servilletero
porte-serviettes



für ca. 50 Cocktailservietten, inklusive Beschwerer

for approx. 50 cocktail napkins, including weight
para aprox. 50 servilletas cocktail, con barrita de contrapeso
pour environ 50 serviettes cocktail, avec barre de contrepoids

	cm	↑ cm
11762	14 x 14	6,5

für 50 Servietten 1/4 Falz, inklusive Beschwerer

for 50 napkins 1/4 fold, including weight
para 50 servilletas plegado 1/4, con barrita de contrapeso
pour 50 serviettes pliage 1/4, avec barre de contrepoids

	cm	↑ cm
11763	19 x 19	6,5

für 150 Servietten 1/4 Falz, inklusive Beschwerer

for 150 napkins 1/4 fold, including weight
para 150 servilletas plegado 1/4, con barrita de contrapeso
pour 150 serviettes pliage 1/4, avec barre de contrepoids

	cm	↑ cm
11765	19 x 19	19,0



inklusive Beschwerer
including weight

NAPKIN HOLDERS



Serviettenhalter

napkin holder
servilletero
porte-serviettes



für ca. 20 Servietten, matt poliert, möbelschonende Unterseite,
for approx. 20 napkins, matt polished, furniture-friendly underside
para aprox. 20 servilletas, pulido mate, con base anti rayaduras
pour environ 20 serviettes, poli mat, avec revêtement antirayures

	cm	↑ cm
11778	17 x 3	7



Serviettenhalter

napkin holder
servilletero
porte-serviettes



für ca. 30 Servietten, matt poliert, möbelschonende Unterseite
for approx. 30 napkins, matt polished, furniture-friendly underside
para aprox. 30 servilletas, pulido mate, con base anti rayaduras
pour environ 30 serviettes, poli mat, avec revêtement antirayures

	cm	↑ cm
11780	15 x 4,5	12,5



Serviettenhalter „ELEMENT“

napkin holder
servilletero
porte-serviettes



für ca. 50 Servietten, möbelschonende Unterseite
for approx. 50 napkins, furniture-friendly underside
para aprox. 50 servilletas, con base anti rayaduras
pour environ 50 serviettes, avec revêtement antirayures

	cm	↑ cm
11781	16 x 7,5	10



NEW

Besteckbehälter / Korb
 cutlery bin / basket
 porta cubiertos / cesta
 range-couverts / corbeille
matt poliert, Boden: 29 x 8,5 cm
 matt polished, base: 29 x 8,5 cm
 pulido mate, base: 29 x 8,5 cm
 poli mat, fond: 29 x 8,5 cm



	cm	↑ cm	ltr.	Farbe / Colour
11752	29,5 x 12	10	2	



Präsentationsmöglichkeit
 presentation example



NEW

Besteckbehälter / Korb
 cutlery bin / basket
 porta cubiertos / cesta
 range-couverts / corbeille
Boden: 29 x 8,5 cm
 base: 29 x 8,5 cm
 base: 29 x 8,5 cm
 fond: 29 x 8,5 cm



	cm	↑ cm	ltr.	Farbe / Colour
11753	29,5 x 12	10	2	



Präsentationsmöglichkeit
 presentation example

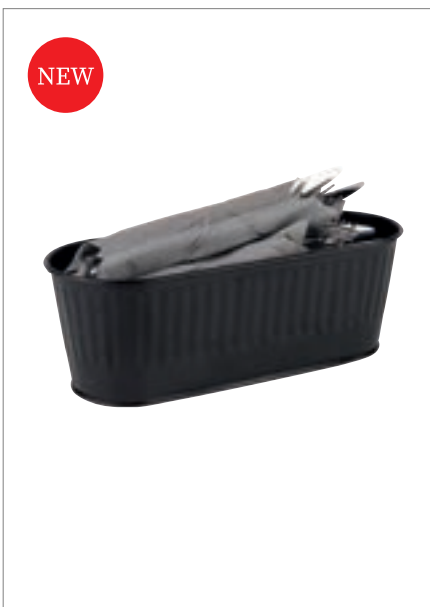

NEW

Besteckbehälter / Korb
 cutlery bin / basket
 porta cubiertos / cesta
 range-couverts / corbeille
Boden: 29 x 8,5 cm
 base: 29 x 8,5 cm
 base: 29 x 8,5 cm
 fond: 29 x 8,5 cm



	cm	↑ cm	ltr.	Farbe / Colour
11754	29,5 x 12	10	2	



Präsentationsmöglichkeit
 presentation example

CUTLERY BOXES



Besteckbehälter

cutlery box
recipiente para cubiertos
réceptif pour couverts

Akazienholz, 4 Fächer (26 x 11,5 cm)

acacia wood, 4 compartments (26 x 11,5 cm)

madera de acacia, 4 compartimentos (26 x 11,5 cm)

bois d'acacia, 4 compartiments (26 x 11,5 cm)



	cm	↑ cm	Farbe / Colour	
11952	51 x 28	13		nature
11951	51 x 28	13		vintage white



Besteckbehälter mit Deckel

cutlery box with cover
caja de cubiertos con tapa
range-couverts avec couvercle

Akazienholz, 4 Fächer (26 x 11,5 cm), mit Deckel

acacia wood, 4 compartments (26 x 11,5 cm), with cover

madera de acacia, 4 compartimentos (26 x 11,5 cm), con tapa

bois d'acacia, 4 compartiments (26 x 11,5 cm), avec couvercle



	cm	↑ cm	Farbe / Colour	
11949	51 x 28	14,5		nature
11948	51 x 28	14,5		vintage white



GN 1/1 Besteckbehälter

GN 1/1 dispenser GN
GN 1/1 dispensador de cubiertos
GN 1/1 bac à couverts

in Handarbeit geflochten, 4 Mulden, Kunststoff-Geflecht, Drahtgestell, braun-schwarz

hand-woven, 4 troughs, plastic wickerwork, wire frame, brown-black

cesta trensada a mano, 4 compartimentos, mimbre de plástico, marco de alambre, marrón-negro

corbeille tressée à main, 4 compartiments, plastique tressé, armature en fil métallique, brun-noir



	cm	↑ cm	Farbe / Colour	GN
11966	53 x 32,5	9		1/1



GN 1/1 Besteckbehälter

GN 1/1 cutlery dispenser
GN 1/1 dispensador de cubiertos
GN 1/1 bac à couverts

4 Mulden, Kunststoff-Geflecht, Drahtgestell, beige

4 troughs, plastic wickerwork, wire frame, beige

4 compartimentos, mimbre de plástico, marco de alambre, beige

4 compartiments, plastique tressé, structure métallique, beige



	cm	↑ cm	Farbe / Colour	GN
11965	53 x 32,5	10		1/1



GN 1/1 Besteckbehälter

GN 1/1 cutlery bin
GN 1/1 recipiente para cubiertos
GN 1/1 récipients pour couverts



4 Mulden

4 troughs
4 compartimentos
4 compartments

	cm	↑ cm	Farbe / Colour	GN
11954	53 x 32,5	10	■	1/1
11955	53 x 32,5	10	■	1/1

3 Mulden, 3 Köcher

3 troughs, 3 cutlery baskets
3 compartimentos, 3 cestas para cubiertos
3 compartments, 3 corbeilles à couverts

	cm	↑ cm	Farbe / Colour	GN
11960	53 x 32,5	10	■	1/1



Besteckbehälter

cutlery basket
recipiente para cubiertos
récipients pour couverts



4 Löcher inklusive 4 Edelstahl Köcher

4 holes including 4 stainless baskets
4 agujeros con 4 cestas de acero inoxidable
4 trous avec 4 corbeilles en acier inox

	cm	↑ cm	Farbe / Colour
93321	27 x 27	15	■



Besteckköcher

cutlery basket
cesta para cubiertos
corbeille à couverts



Polyethylen weiß / polyethylene white plastic / polietileno blanco / polyéthylène blanc

	Ø cm	↑ cm
11998	9,5	13,5

Edelstahl matt poliert / stainless steel matt polished / acero inoxidable pulido mate / acier inox poli mat

	Ø cm	↑ cm
11999	9,5	13,5



Besteckkasten „INDUSTRIAL“

cutlery box
caja para cubiertos
boîte pour couverts



Metall, schwarz

metal, black
metal, negro
métal, noir

	cm	↑ cm	litr.
40676	23,0 x 15,5	13,0	2,4

BUFFET STANDS

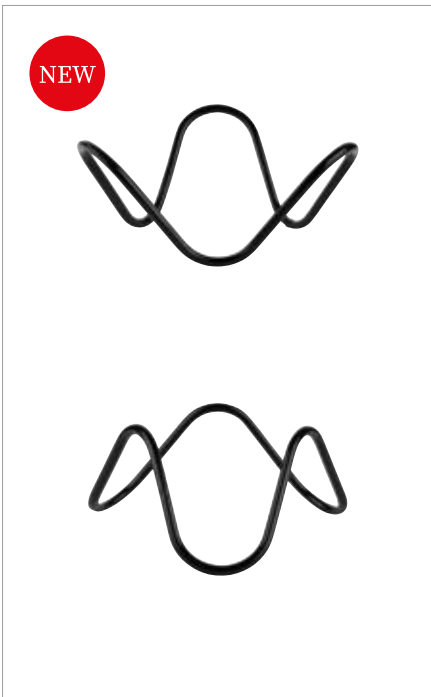

NEW

Buffetständer „WAVE“

buffet stand
soporte de buffet
support de buffet
mit Antirutschbeschichtung
with non-slip coating
con revestimiento antideslizante
avec revêtement antidérapant



	Ø cm	↑ cm
33306	20	9,5



Präsentationsmöglichkeit
presentation example

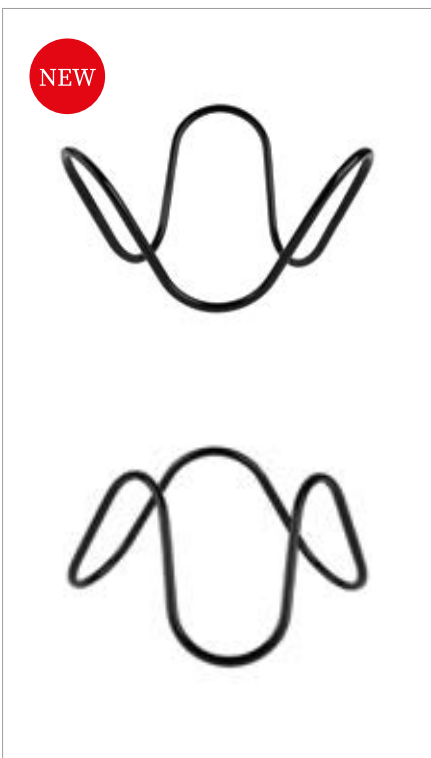

NEW

Buffetständer „WAVE“

buffet stand
soporte de buffet
support de buffet
mit Antirutschbeschichtung
with non-slip coating
con revestimiento antideslizante
avec revêtement antidérapant



	Ø cm	↑ cm
33307	24	13

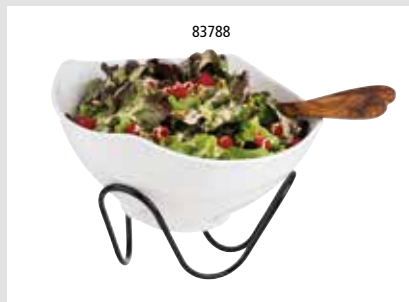

Präsentationsmöglichkeit
presentation example

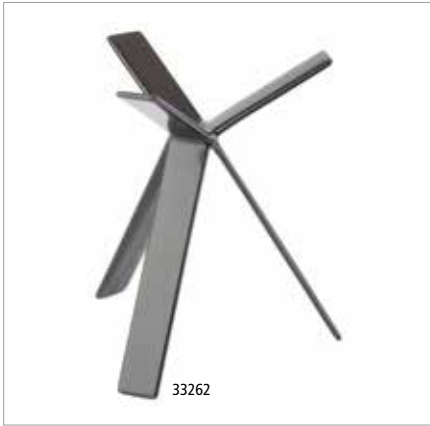

Buffetständer „STAR“

buffet stand
soporte para buffet
présentoire buffet

Metall, mit schwarzer Antirutschbeschichtung

metal, with black anti-slide coating
metal, con revestimiento antideslizante negro
métal, avec revêtement antidérapant noir



	↑ cm
33260	8
33261	12
33262	18



Buffetständer „MULTI“

buffet stand
soporte para buffet
présentoir buffet

Metall, mit schwarzer Antirutschbeschichtung

metal, with black anti-slide coating
metal, con revestimiento antideslizante negro
métal, avec revêtement antidérapant noir



	Ø cm	↑ cm
33269	15,5 / 18	8
33270	15,5 / 18	10
33271	15,5 / 18	18

	cm	↑ cm
33249	18 x 18	5
33250	18 x 18	8
33251	18 x 18	10
33252	18 x 18	18



Buffetständer „PRISMA“

buffet stand
soporte para buffet
présentoir buffet

Metall, mit schwarzer Antirutschbeschichtung

metal, with black anti-slide coating
metal, con revestimiento antideslizante negro
métal, avec revêtement antidérapant noir



	Ø cm	↑ cm
33272	20	10,5
33273	20	20,0



Buffetständer „KING“

buffet stand
soporte para buffet
présentoir buffet

kein Verrutschen, Arme und Boden sind mit Antirutschflächen ausgestattet, schwere standsichere Qualität, Fuß dient als Löffelablage

the arms and base are equipped with non-slip surfaces, stable quality, base serves as spoon holder

revestimiento antideslizante en las puntas de los brazos y en la base, estable y alta calidad, la base sirve como reposacuchara

revêtement antidérapant sur les extrémités des 3 pieds et sur la base, robuste, stable et bonne qualité, la base sert de support pour les couverts



	Ø cm	↑ cm
03622	15	14
03623	15	21

BUFFET STANDS

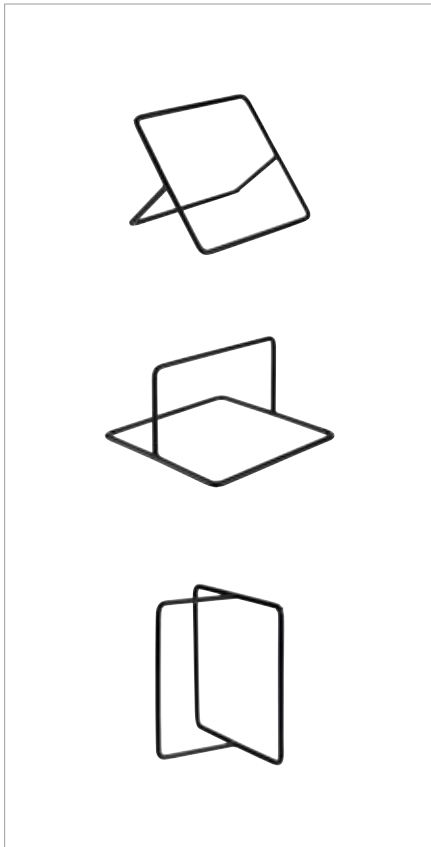

Buffetständer „SQUARE“

buffet stand
soporte para buffet
présentoir buffet

Metall, mit schwarzer Antirutschbeschichtung

metal, with black anti-slide coating
metal, con revestimiento antideslizante negro
métal, avec revêtement antidérapant noir



	cm	↑ cm
33305	12 x 12	7



Präsentationsmöglichkeit | presentation example



Buffetständer „PERFECTO“

buffet stand
soporte para buffet
présentoir buffet

Metall, mit schwarzer Antirutschbeschichtung

metal, with black anti-slide coating
metal, con revestimiento antideslizante negro
métal, avec revêtement antidérapant noir



	cm	↑ cm	fits to
33304	19 x 23	40,5	33202, 33303



Buffetständer „FRIDA“

buffet stand
soporte para buffet
présentoir buffet

Metall, mit schwarzer Antirutschbeschichtung

metal, with black anti-slide coating
metal, con revestimiento antideslizante negro
métal, avec revêtement antidérapant noir



	∅ cm	↑ cm	fits to
33282	23 / 30,5	17	85230, 85231

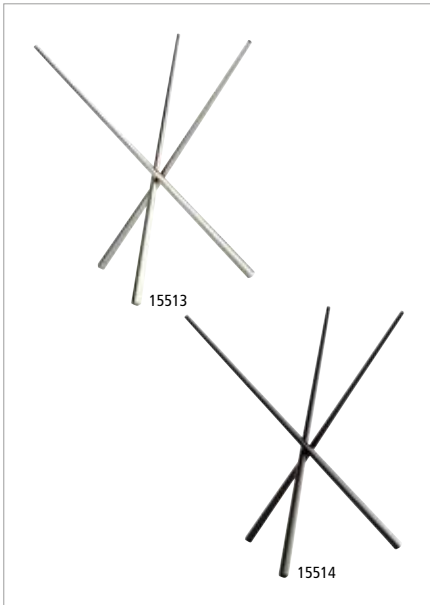

Buffetständer „ASIA PLUS“

buffet stand
soporte para buffet
présentoir buffet



	Ø cm	↑ cm	Farbe / Colour
15513	20,5 / 16,5	20	—
15514	20,5 / 16,5	20	—



Präsentationsmöglichkeit
presentation example



Buffetständer

buffet stand
expositor de buffet
présentoir buffet



Akazienholz
acacia wood
madera de acacia
bois d'acacia

	Ø cm	↑ cm
33255	15	10
33256	25	15



Präsentationsmöglichkeit
presentation example



Buffetständer „WOOD“

buffet stand
soporte para buffet
présentoire buffet



Akazienholz, liegend oder stehend, variable Nutzungsmöglichkeiten
acacia wood, usable by lying or standing, variable usage possibilities
madera de acacia, se puede usar tumbado o de pie, opciones de uso variable
bois d'acacia, possibilités d'utilisation variables

	cm	↑ cm	Farbe / Colour
33280	20 x 20	17,5	—
33281	20 x 20	17,5	—



liegend oder stehend, variable Nutzungsmöglichkeiten
vertically or horizontally, variable usage possibilities

NEW

MANGO



NEW



01050



01053



01056



01057

Schale

bowl
cuenco
bol

HOLZ
WOOD

MAX
40°C



Mangoholz, Epoxidharz, Motiv (innen): starry sky
mango wood, epoxy resin, design (inside): starry sky
madera de mango, resina epoxi, diseño (interior): starry sky
bois de manguier, résine époxy, design (intérieur): starry sky

	Ø cm	↑ cm	ltr.
01050	20	7,5	0,8
01053	24	7,5	1,1
01056	30	10,5	3,0
01057	37	9,0	4,0



handgefertigt
handmade

NEW



Tablett / Teller

tray / plate
bandeja / plato
plateau / assiette

HOLZ
WOOD

MAX
40°C



Mangoholz, Epoxidharz, Motiv (innen): starry sky
mango wood, epoxy resin, design (inside): starry sky
madera de mango, resina epoxi, diseño (interior): starry sky
bois de manguier, résine époxy, design (intérieur): starry sky

	Ø cm	↑ cm
01058	35,5	2,5

**Schale**bowl
cuenco
bol

Mangoholz, Epoxidharz, Motiv (innen): Sicily
 mango wood, epoxy resin, design (inside): sicily
 madera de mango, resina epoxi, diseño (interior): sicily
 bois de manguier, résine époxy, design (intérieur): sicily

	Ø cm	↑ cm	ltr.
01052	24	7,5	1,1
01055	30	10,5	3,0

handgefertigt
handmade**Schale**bowl
cuenco
bol

Mangoholz, Epoxidharz, Motiv (innen): weiß+blau
 mango wood, epoxy resin, design (inside): white+blue
 madera de mango, resina epoxi, diseño (interior): blanco+azul
 bois de manguier, résine époxy, design (intérieur): blanc+bleu

	Ø cm	↑ cm	ltr.
01051	24	7,5	1,1
01054	30	10,5	3,0

handgefertigt
handmade

ACACIA



00794 1,8 ltr.



00795 2,5 ltr.



00796 3,0 ltr.

Schale „ACACIA“

bowl
cuenco
bol

aus geöltem Akazienholz
made of oiled acacia wood
de madera de acacia aceitada
en bois d'acacia huilé



	Ø cm	↑ cm	ltr.
00794	21	8,5	1,8
00795	25	8,5	2,5
00796	27	8,5	3,0



3 Größen ineinander
3 sizes in each other



33269

Buffetständer „MULTI ROUND“

buffet stand
soporte para buffet
présentoir buffet

Metall, mit schwarzer Antirutschbeschichtung
metal, with black anti-slide coating
metal, con revestimiento antideslizante negro
métal, avec revêtement antidérapant noir



	Ø cm	↑ cm
33269	15,5 / 18	8
33270	15,5 / 18	10
33271	15,5 / 18	18

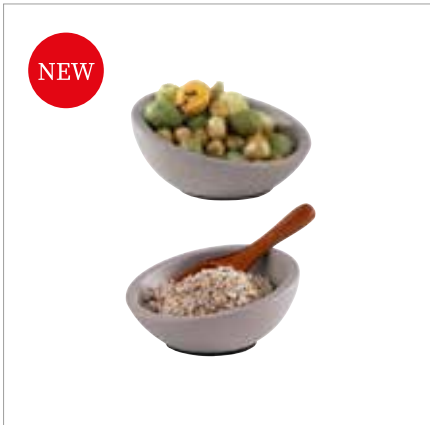

NEW

Schale, 3er Set „ELEMENT“

bowl, 3 pcs.
cuenco, set de 3
bol, set de 3



	Ø cm	↑ cm	ltr.	pcs.
30003	10	4,5	0,05	3



möbelschonende Unterseite
furniture-friendly underside



Schale „ELEMENT“

bowl
cuenco
bol



	Ø cm	↑ cm	ltr.
30000	22	6,0 / 10,5	1,1
30001	26	7,5 / 13,0	1,7
30002	29,5	8,5 / 14,5	2,5



möbelschonende Unterseite
furniture-friendly underside



Präsentationsmöglichkeiten
presentation example

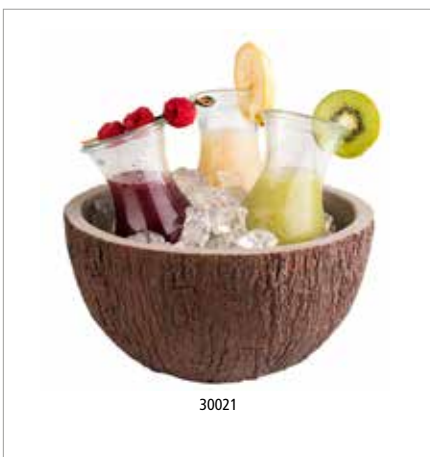

Schale „COCONUT“

bowl
cuenco
bol



	Ø cm	↑ cm	ltr.
30020	18	9,5	1
30021	23	12,5	2,2



möbelschonende Unterseite
furniture-friendly underside



Buffetständer

buffet stand
expositor de buffet
présentoir buffet



Akazienholz / acacia wood / madera de acacia / bois d'acacia

	Ø cm	↑ cm
33255	15	10
33256	25	15



CEREAL DISPENSERS



Cerealienspender „FRESH & EASY“

cereal dispenser
dispensador de cereales
distributeur de céréales



Behälter herausnehmbar, „Feierabend-Deckel“ für das aromadichte Lagern, portionieren durch einfaches Drehen

removable canister, special lid to keep the cereals fresh, easy to use, rotate the button to get the muesli

contenedor extraíble, tapa especial para mantener los cereales frescos, fácil de usar, se gira el pomo para servir los cereales

réipient amovible, couvercle spécial pour conserver les céréales, usage facile en tournant le bouton

	cm	↑ cm	ltr.	Farbe / Colour
11840	22 x 17,5	52	4,5	■



Cerealienspender Duo „FRESH & EASY“

cereal dispenser
dispensador de cereales
distributeur de céréales



Behälter herausnehmbar, „Feierabend-Deckel“ für das aromadichte Lagern, portionieren durch einfaches Drehen

removable canister, special lid to keep the cereals fresh, easy to use, rotate the button to get the muesli

contenedor extraíble, tapa especial para mantener los cereales frescos, fácil de usar, se gira el pomo para servir los cereales

réipient amovible, couvercle spécial pour conserver les céréales, usage facile en tournant le bouton

	cm	↑ cm	ltr.	Farbe / Colour
11841	22 x 35	52	2 x 4,5	■



4,5 ltr.

Cerealienspender „FRESH & EASY“

cereal dispenser
dispensador de cereales
distributeur de céréales



Behälter herausnehmbar, „Feierabend-Deckel“ für das aromadichte Lagern, portionieren durch einfaches Drehen

removable canister, special lid to keep the cereals fresh, easy to use, rotate the button to get the muesli
contenedor extraíble, tapa especial para mantener los cereales frescos, fácil de usar, se gira el pomo para servir los cereales
récipient amovible, couvercle spécial pour conserver les céréales, usage facile en tournant le bouton

	cm	↑ cm	ltr.
11805	22 x 17,5	52	4,5



2 x 4,5 ltr.

Cerealienspender Duo „FRESH & EASY“

cereal dispenser
dispensador de cereales
distributeur de céréales



Behälter herausnehmbar, „Feierabend-Deckel“ für das aromadichte Lagern, portionieren durch einfaches Drehen

removable canister, special lid to keep the cereals fresh, easy to use, rotate the button to get the muesli
contenedor extraíble, tapa especial para mantener los cereales frescos, fácil de usar, se gira el pomo para servir los cereales
récipient amovible, couvercle spécial pour conserver les céréales, usage facile en tournant le bouton

	cm	↑ cm	ltr.
11807	22 x 35	52	2 x 4,5



Cerealienspender „ROTATION“

cereal dispenser
dispensador de cereales
distributeur de céréales



matt poliert, drehbarer massiver Ständer, Behälter herausnehmbar, inklusive Frischhaltedeckel

matt polished, rotating food, canister removable, including airtight covers
pulido mate, giratorio, incluye tapas herméticas
poli mat, rotatif, inclut couvercles hermétiques

	Ø cm	↑ cm	ltr.
11970	38	54	3 x 4,5



Cerealienspender „ROTATION“

cereal dispenser
dispensador de cereales
distributeur de céréales



Buchenholz versiegelt, drehbarer massiver Ständer, Behälter herausnehmbar, inklusive Frischhaltedeckel

wood beech covered waterproof, rotating foot, canister removable, incl. airtight cover
tapa en madera de haya resistente al agua, pie giratorio, recipiente extraíble, incluye tapa hermética
couvercle en hêtre traitée contre l'humidité, pied rotatif, récipients démontables, inclut couvercles hermétiques

	Ø cm	↑ cm	ltr.
11975	38	54	3 x 4,5

CEREAL DISPENSERS



Cerealienspender „BRIDGE“

cereal dispenser
dispensador de cereales
distributeur de céréales



Behälter herausnehmbar, „Feierabend-Deckel“ für das aromadichte Lagern, portionieren durch einfaches Drehen

removable canister, special lid to keep the cereals fresh,
easy to use, rotate the button to get the muesli
contenedor extraíble, tapa especial para mantener los cereales frescos,
fácil de usar, se gira el pomo para servir los cereales
récipient amovible, couvercle spécial pour conserver les céréales,
usage facile en tournant le bouton

	cm	↑ cm	ltr.	Farbe / Colour	
13987	21 x 20	55,5	4,5		Ahorn



Cerealienspender „BRIDGE“

cereal dispenser
dispensador de cereales
distributeur de céréales



Behälter herausnehmbar, „Feierabend-Deckel“ für das aromadichte Lagern, portionieren durch einfaches Drehen

removable canister, special lid to keep the cereals fresh,
easy to use, rotate the button to get the muesli
contenedor extraíble, tapa especial para mantener los cereales frescos,
fácil de usar, se gira el pomo para servir los cereales
récipient amovible, couvercle spécial pour conserver les céréales,
usage facile en tournant le bouton

	cm	↑ cm	ltr.	Farbe / Colour	
14987	21 x 20	55,5	4,5		Wenge



Buffetständer „GOOD MORNING“

buffet stand
expositor de buffet
présentoir de buffet



4-teiliges Set: 1 Holzständer inklusive 3 Gläser mit luftdichtem Klappdeckel

4 pcs.: 1 wood stand including 3 glasses with airtight cover

set de 4: 1 soporte con 3 cuencos de cristal con cierre hermético

set de 4: 1 présentoir avec 3 bols en verre avec fermeture hermétique

	cm	Farbe / Colour	
13965	43 x 17		Ahorn
14965	43 x 17		Wenge

Glas mit luftdichtem Klappdeckel

glass with airtight cover
cristal, cierre hermético
verre, fermeture hermétique

	cm	↑ cm	ltr.
82328	12 x 12	22	2



Cerealien-Bar

cereal-bar
barra para dispensador de cereales
bar à céréales



5-teiliges Set: mit Ständerhöhe 4 oder 8 cm: 1 Ständer aus Acryl gefrostet und rutschfest + 2 Karaffen mit schwenkbarem Edelstahl-Deckel + 2 luftdichte Frischhaltedeckel

5 pcs.: with stand heights 4 or 8 cm: 1 stand acryl frosted and non-slip + 2 pitchers with stainless steel flap lid + 2 airtight covers

set de 5: stands a diferentes alturas, 4 u 8 cm: 1 stand acryl + 2 jarras con tapa de solapa de acero inoxidable + 2 tapas herméticas adicionales

set de 5: supports à différentes hauteurs: 4 ou 8 cm - 1 support acrylique satiné antidérapant + 2 pichets à céréales avec couvercle à charnière inox + 2 couvercles hermétiques

	cm	↑ cm	ltr.
11971	26 x 17	28,5	2 x 1,5
11972	26 x 17	32,5	2 x 1,5



ideal für Stufenpräsentation
best for staged presentations



Cerealien-Bar

cereal-bar
barra para dispensador de cereales
bar à céréales



7-teiliges Set: mit Ständerhöhe 4 oder 8 cm: 1 Ständer aus Acryl gefrostet und rutschfest + 3 Karaffen mit schwenkbarem Edelstahl-Deckel + 3 luftdichte Frischhaltedeckel

7 pcs.: with stand heights 4 or 8 cm: 1 stand acryl frosted and non-slip + 3 pitchers with stainless steel flap lid + 3 airtight covers

set de 7: con stands a diferentes alturas, 4 u 8 cm: 1 stand acryl + 3 jarras con tapa de solapa de acero inoxidable + 3 tapas herméticas adicionales

set de 7: supports à différentes hauteurs: 4 ou 8 cm - 1 support acrylique satiné antidérapant + 3 pichets à céréales avec couvercle à charnière inox + 3 couvercles hermétiques

	cm	↑ cm	ltr.
11973	38 x 17	28,5	3 x 1,5
11974	38 x 17	32,5	3 x 1,5

Cerealienkaraffe

cereal pitcher
jarra de cereales
pichet à céréales



schwenkbarer Edelstahl-Deckel, inklusive luftdichtem Frischhaltedeckel

stainless steel flap lid, incl. 1 airtight cover

tapa giratoria de acero inoxidable con tapa hermética para mantener los alimentos frescos

couvercle pivotant en acier inox avec couvercle hermétique pour conserver les aliments

	Ø cm	↑ cm	ltr.
10778	10	28	1,5

Frischhaltedeckel / conservation lid / tapa de conservación / couvercle de conservation

10668



BUFFET LADDER



Buffetleiter „BIG“

buffet ladder
dispensador en escalera
présentoir buffet en escalier



12-teiliges Set: 4 Glasschalen Ø 23 cm 2,5 Liter, 4 klappbare Schutzdeckel mit Beschriftungsfenster, 1 Leiter, 1 Doppelring, 2 Einzelringe, einfach und individuell zusammensetzbar

12 pcs. set: 4 glass bowls Ø 23 cm 2.5 litres, 4 hinged covers with card for inscription, 1 ladder, 1 double ring, 2 single rings, easy to fix and individual to use
set de 12: 4 cuencos de vidrio Ø 23 cm 2,5 l, 4 tapas abatibles con ventana para etiqueta, 1 soporte escalera, 1 aro doble, 2 aros sencillos, fácil de montar, posible usar individualmente
set de 12: 4 bols en verre Ø 23 cm 2,5 l, 4 couvercles à charnière et fenêtre pour étiquette, 1 support escalier, 1 cercle double, 2 cercles simples, montage facile, utilisable individuellement

	cm	↑ cm
11598	39 x 31	66



Buffetleiter „BIG“

buffet ladder
dispensador en escalera
présentoir buffet en escalier



11-teiliges Set: 6 Glasschalen Ø 23 cm 2,5 Liter, 1 Leiter, 2 Doppelringe, 2 Einzelringe, einfach und individuell zusammensetzbar

11 pcs. set: 6 glass bowls Ø 23 cm 2.5 litres, 1 ladder, 2 double rings, 2 single rings, easy and individual to use
set de 11: 6 cuencos de vidrio Ø 23 cm 2,5 l, 1 soporte escalera, 2 aros dobles, 2 aros sencillos, fácil montar, se puede usar individualmente
set de 11: 6 bols en verre Ø 23 cm 2,5 l, 1 support escalier, 2 cercles doubles, 2 cercles simples, montage facile, utilisable individuellement

	cm	↑ cm
11599	39 x 31	66

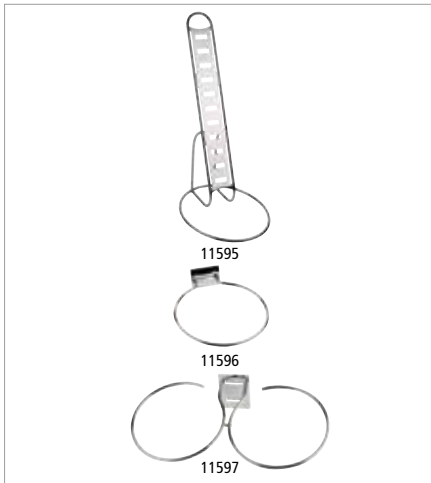

Einzelteile / spare parts / piezas de recambio / pièces détachées

Leitergestell / frame / marco solo / échelle support

	cm	↑ cm
11595	39 x 31	66

Einzelring / single ring / aro sencillo / cercle simple

	Ø cm
11596	23,5

Doppelring / double ring / aro doble / cercle double

	cm
11597	48 x 23,5



Schale

bowl
cuenco
bol



	Ø cm	↑ cm	ltr.
11875	23	10,5	2,5



Schutzdeckel mit Löffelaussparung

cover
tapa
couvercle



	Ø cm
11878	23,5



Buffeteleiter „LITTLE“

buffet ladder
dispensador en escalera
présentoir buffet en escalier



12-teiliges Set: 4 Glasschalen Ø 14 cm 0,5 Liter, 4 klappbare Schutzdeckel mit Beschriftungsfenster, 1 Leiter, 1 Doppelring, 2 Einzelringe, einfach und individuell zusammensetzbar

12 pcs. set: 4 glass bowls Ø 14 cm 0.5 litres, 4 hinged covers with card for inscription, 1 ladder, 1 double ring, 2 single rings, easy and individual to use
set de 12: 4 cuencos de vidrio Ø 14 cm 0,5 l, 4 tapas abatibles con ventana para etiqueta, 1 soporte escalera, 1 aro doble, 2 aros sencillos, fácil montaje, se puede usar individualmente
set de 12: 4 bols en verre Ø 14 cm 0,5 l, 4 couvercles à charnière et fenêtre pour étiquette, 1 support escalier, 1 cercle double, 2 cercles simples, montage facile, utilisable individuellement

	cm	↑ cm
11498	30 x 30	48



Buffeteleiter „LITTLE“

buffet ladder
dispensador en escalera
présentoir buffet en escalier



11-teiliges Set: 6 Glasschalen Ø 14 cm 0,5 Liter, 1 Leiter, 2 Doppelringe, 2 Einzelringe, einfach und individuell zusammensetzbar

11 pcs. set: 6 glass bowls Ø 14 cm 0.5 litres, 1 ladder, 2 double rings, 2 single rings, easy and individual to use
set de 11: 6 cuencos de vidrio Ø 14 cm 0,5 l, 1 soporte escalera, 2 aros dobles, 2 aros sencillos, fácil montaje, se puede usar individualmente
set de 11: 6 bols en verre Ø 14 cm 0,5 l, 1 support escalier, 1 cercles doubles, 2 cercles simples, montage facile, utilisable individuellement

	cm	↑ cm
11499	30 x 30	48

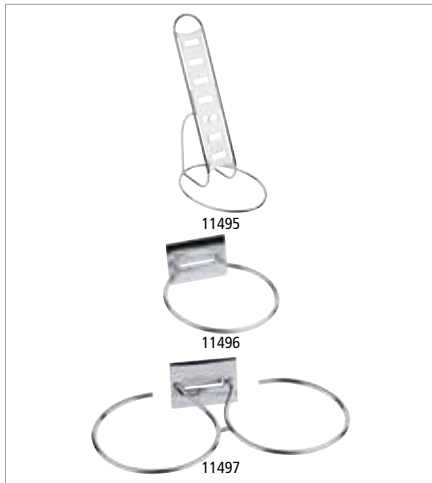

Einzelteile / spare parts / piezas de recambio / pièces détachées

Leitergestell / frame / marco solo / échelle support

	Ø cm	↑ cm
11495	30	48

Einzelring / single ring / aro sencillo / cercle simple

	Ø cm
11496	14

Doppelring / double ring / aro sencillo / cercle double

	cm	cm
11497	29,5 x 14,5	48



Schale

bowl
cuenco
bol



	Ø cm	↑ cm	ltr.	VE / unit
11865	14	6,5	0,5	6



Schutzdeckel mit Löffelaussparung

cover
tapa
couvercle



	Ø cm
11868	14,5

BUFFET DISPLAY



Buffetgestell „SUNDAY“

buffet stand
expositor buffet
présentoir buffet



7-teiliges Set: 3 Glasschalen Ø 23 cm (2,5 Liter), 3 klappbare Schutzdeckel, 1 Gestell

7 pcs. set: 3 glass bowls Ø 23 cm (2,5 litres), 3 hinged covers, 1 stand

set de 7: 3 cuencos de cristal Ø 23 cm (2,5 litro), 3 tapas con bisagra, 1 soporte

set de 7: 3 bols en verre Ø 23 cm (2,5 litre), 3 couvercles à charnière, 1 support

	cm	↑ cm
11795	61 x 24	35



Schälchenspender „MINI“

bowl holder
rack dispensador para cuencos
porte-bols



geeignet für Schalen Ø 6 cm, bestückbar mit bis zu 36 Schalen

for bowls Ø 6 cm, suitable for 36 bowls

para cuencos de Ø 6 cm, apto para 36 cuencos

pour bols de Ø 6 cm, pour 36 bols

	Ø cm	↑ cm	
11981	14	25,5	Ständer inklusive 36 Glasschalen, Ø 6 cm frame with 36 bowls, Ø 6 cm
11986	14	25,5	Ständer inklusive 36 Melaminschalen, Ø 6 cm frame with 36 melamine bowls, Ø 6 cm

Schälchenspender „MINI“ / bowl holder / rack dispensador para cuencos / porte-bols

	Ø cm	↑ cm	
11980	14	25,5	Ständer ohne Schalen / frame without bowls soporte sin cuencos / support sans bols



Serviergestell „WECK“

serving stand
expositor
présentoir

ohne Gläser
without glasses
sin tarros
sans verrines



	Ø cm	↑ cm	
33246	22	59	12 x Ø 6 cm

passende Gläser / matching glasses / tarros adecuados / verrines appropriées

	Ø cm	↑ cm	ltr.	pcs
82310	6	5,5	0,08	12
82312	6	7,0	0,14	12
82314	6	8,0	0,16	12

NEW



Buffet Box

buffet box
caja buffet
boîte à buffet

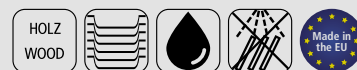

Eichenholz, geölt, Innenmaße: 15,5 x 10 cm

oak wood oiled, interior dimensions: 15,5 x 10 cm
madera de roble aceitada, medidas int.: 15,5 x 10 cm
bois de chêne huilé, dimensions int.: 15,5 x 10 cm

	cm	↑ cm
11728	17,5 x 15,5	12,5

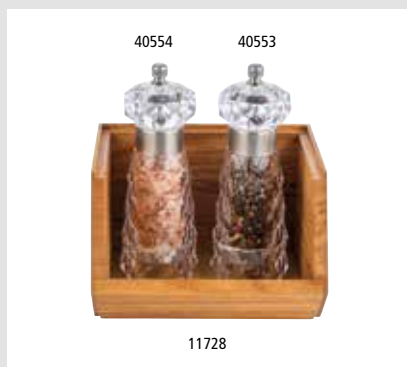

Präsentationsmöglichkeit
presentation example



stapelbar
stackable

NEW



Buffet Box

buffet box
caja buffet
boîte à buffet



aus geöltem Eichenholz, 2 Fächer je: 25 x 16 cm, mit 2 Griffmulden

made of oiled oak wood, 2 compartments: each 25 x 16 cm, with 2 recessed grips
de madera de roble aceitada, 2 compartimentos de 25 x 16 cm, con 2 asas empotradas
en bois de chêne huilé, 2 compartiments: chacun 25 x 16cm, avec 2 poignées encastrées

	cm	↑ cm
11729	35 x 31	12,5



Präsentationsmöglichkeit
presentation example



stapelbar
stackable

BUFFET LADDER GN



Buffetleiter „LITTLE GN 1/3“

buffet ladder
dispensador en escalera
présentoir buffet en escalier

4-teilig: 1 Leiter-Gestell, 3 GN 1/3 Rahmen

4 pcs.: 1 ladder, 3 single rings GN 1/3

set de 4: 1 soporte escalera, 3 aros sencillos GN 1/3

set de 4: 1 support escalier, 3 cercles simples GN 1/3



	cm	↑ cm	fits to
11526	31,5 x 32	48	baskets / pans GN 1/3



Buffetleiter „LITTLE GN 1/2“

buffet ladder
dispensador en escalera
présentoir buffet en escalier

4-teilig: 1 Leiter-Gestell, 3 GN 1/3 Rahmen

4 pcs.: 1 ladder, 3 single rings GN 1/3

set de 4: 1 soporte escalera, 3 aros sencillos GN 1/3

set de 4: 1 support escalier, 3 cercles simples GN 1/3



	cm	↑ cm	fits to
11527	31,5 x 41,5	48	baskets / pans GN 1/2

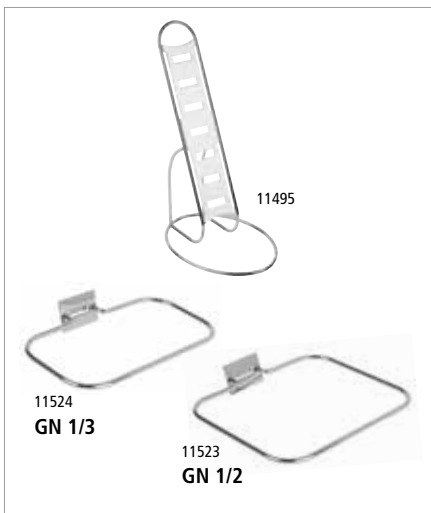

Einzelteile / spare parts / piezas sueltas / pièces détachées

Leitergestell / frame / marco de escalera / échelle support

11495

Einzelring GN 1/3 / single ring GN 1/3 / aro sencillo GN 1/3 / cercle simple GN 1/3

11524

Einzelring GN 1/2 / single ring GN 1/2 / aro sencillo GN 1/2 / cercle simple GN 1/2

11523



2x 84304
GN 1/4

1x 83757
GN 1/2

1x 83757
GN 1/2

1x 83757
GN 1/2

4 tlg.
4 pcs.

Buffetleiter „BIG GN 1/2“
buffet ladder
dispensador en escalera
présentoir buffet en escalier

5-teilig: 1 Leiter-Gestell, 4 GN 1/2 Rahmen
5 pcs.: 1 ladder, 4 single rings GN 1/2
set de 5: 1 soporte escalera, 4 aros sencillos GN 1/2
set de 5: 1 support escalier, 4 cercles simples GN 1/2

	cm	↑ cm	fits to
11528	31,5 x 56	66	baskets / pans GN 1/2

METALL
VERCHROMT

3x 83753
GN 1/3

2x 83757
GN 1/2

1x 83759
GN 1/1

4 tlg.
4 pcs.

Buffetleiter „BIG GN 1/1“
buffet ladder
dispensador en escalera
présentoir buffet en escalier

4-teilig: 1 Leiter-Gestell, 3 GN 1/1 Rahmen
4 pcs.: 1 ladder, 3 single rings GN 1/1
set de 4: 1 soporte escalera, 3 aros sencillos GN 1/1
set de 4: 1 support escalier, 3 cercles simples GN 1/1

	cm	↑ cm	fits to
11529	52 x 59	66	baskets / pans GN 1/1

METALL
VERCHROMT

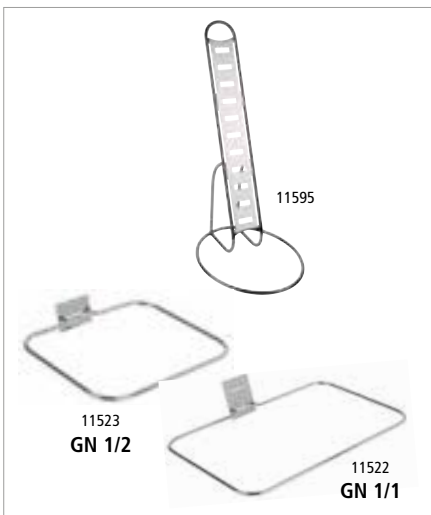

Einzelteile / spare parts / piezas sueltas / pièces détachées

Leitergestell / frame / marco de escalera / échelle support

11595

Einzelring GN 1/2 / single ring GN 1/2 / aro sencillo GN 1/2 / cercle simple GN 1/2

11523

Einzelring GN 1/1 / single ring GN 1/1 / aro sencillo GN 1/1 / cercle simple GN 1/1

11522



BEVERAGE DISPENSERS



Getränkespender „INDUSTRIAL“

beverage dispenser
dispensador de bebidas
distributeur de boissons



Behälter aus Glas, Zapfhahn aus Edelstahl, Fuß und Deckel aus Metall, schwarz, Antirutschmatte aus Silikon

glass container, stainless steel tap, base and lid in black metal, silicone non-slip mat
recipiente de vidrio, grifo de acero inoxidable, base y tapa de metal negro, tapete antideslizante de silicona

réceptien en verre, robinet en acier inox, pied et couvercle en métal noir, tapis antidérapant en silicone

	Ø cm	↑ cm	ltr.	
10450	20	45	7	inkl. Gestell / incl. stand



Antirutschmatte aus Silikon
silicone anti-slip mat



Getränkespender „URBAN“

beverage dispenser
dispensador de bebidas
distributeur de boissons



Behälter aus Glas, Zapfhahn aus Edelstahl, Fuß und Deckel aus Metall, schwarz, Antirutschmatte aus Silikon

glass container, stainless steel tap, base and lid in black metal, silicone non-slip mat
recipiente de vidrio, grifo de acero inoxidable, base y tapa de metal negro, tapete antideslizante de silicona

réceptien en verre, robinet en acier inox, pied et couvercle en métal noir, tapis antidérapant en silicone

	Ø cm	↑ cm	ltr.	
10451	22	45	7	inkl. Gestell / incl. stand



Antirutschmatte aus Silikon
silicone anti-slip mat



Eiswasserröhre

ice cube cooling tube
tubo enfriador para cubitos
tube pour glaçons



	Ø cm	↑ cm	passend für Getränkenspender / fits to drink dispenser
10849	11	24	10400, 10403, 10450, 10451, 10855



Getränkespender
beverage dispenser
dispensador de bebidas
distributeur de boissons



Eichenholz (wasserfest lackiert), Zapfhahn aus Edelstahl, Untersetzer aus Melamin, Bodenplatte (Abtropfgitter) herausnehmbar

oak wood (waterproof lacquered), Stainless steel tap, melamine coaster, removeable base plate
madera de roble (lacado impermeable), grifo de acero inoxidable, posavasos de melamina, placa base desmontable
bois de chêne (vernis imperméable), binet en acier inoxydable, dessous de verre en mélamine, plaque de fond amovible

	cm	↑ cm	ltr.
14015	21 x 21	46,5	7
14016	43,5 x 21	46,5	2 x 7



Getränkespender „ASIA“
beverage dispenser
dispensador de bebidas
distributeur de boissons



Behälter aus Glas, Zapfhahn aus Edelstahl, Fuß und Deckel aus Holz

glass container, stainless steel tap, wooden stand and lid
recipiente de vidrio, grifo de acero inoxidable, soporte y tapa de madera
récipient en verre, robinet en acier inox, support et couvercle en bois

	Ø cm	↑ cm	ltr.
10403	24,5	45,5	7

inkl. Gestell / incl. stand

Ersatz-Fuß / base / soporte de recambio / support de remplacement

	Ø cm	↑ cm
10404	24,5	15

Ersatz-Deckel / replacement lid / tapa de recambio / couvercle de rechange

	Ø cm	↑ cm
10405	14,0	5



Getränkespender „ELEMENT“
beverage dispenser
dispensador de bebidas
distributeur de boissons



Behälter aus Glas, Zapfhahn aus Edelstahl, Fuß und Deckel aus Beton

glass container, stainless steel tap, stand and lid made of concrete
recipiente de vidrio, grifo de acero inoxidable, soporte y tapa de hormigón
récipient en verre, robinet en acier inox, support et couvercle en béton

	Ø cm	↑ cm	ltr.
10400	22	45	7

inkl. Gestell / incl. stand

BEVERAGE DISPENSERS



Getränkespender

beverage dispenser
dispensador de bebidas
distributeur de boissons



Behälter aus Glas, Zapfhahn aus Edelstahl, Deckel aus Edelstahl

glass container, stainless steel tap, lid in stainless steel

recipiente de vidrio, grifo de acero inoxidable, tapa de acero inoxidable

réipient en verre, robinet en acier inox, couvercle en acier inox

	Ø cm	↑ cm	ltr.
10818 NEW	16	25	3,8
10855	20	30,5	7



Präsentationsmöglichkeit
presentation example



Unterteller

saucer
plattillo
sous-assiette



mit Antirutsch-Füßchen, passend zu Getränkenspender Nr. 10855

with non-slip feet, suitable for drinkdispenser art. 10855

con pies antideslizantes, para distribuidor de bebidas art. 10855

pour distributeur de boissons art. 10855

	Ø cm	↑ cm	Farbe / Colour
85232	19	1	■



Tropfenschale, 2-teilig

drip tray, 2 pcs.
aros anti-goteo, set de 2
anneaux coupe-gouttes, set de 2



	Ø cm	↑ cm	Farbe / Colour
10851	9,5	1,5	■ white
10853	9,5	1,5	■ anthracite
10841 NEW	9,5	1,5	■ black



Getränkespender „OLD FASHIONED“

beverage dispenser
dispensador de bebidas
distributeur de boissons



Behälter aus Glas, Zapfhahn aus Edelstahl, Gestell schwarz

glass container, stainless steel tap, black stand

recipiente de vidrio, grifo de acero inoxidable, soporte negro

réipient en verre, robinet en acier inox, support noir

	Ø cm	↑ cm	ltr.
10409	27	50,5	7

inkl. Gestell / incl. stand
Ersatz-Gestell / stand / soporte de recambio / support de remplacement

	Ø cm	↑ cm
10410	27	31,5

Ersatz-Glas / replacement glass / cristal de recambio / vitre de rechange

	Ø cm	↑ cm	ltr.
10411	19	36,5	7

Ersatz-Zapfhahn / replacement tap

10718



10,5 ltr.

Trinkglas „BEACH“
300 ml 10505

Getränkespender „FRUITS“

beverage dispenser
dispensador de bebidas
distributeur de boissons



Behälter aus Glas, Zapfhahn aus Edelstahl, Gestell schwarz

glass container, stainless steel tap, black stand
recipiente de vidrio, grifo de acero inoxidable, soporte negro
récipient en verre, robinet en acier inox, support noir

	Ø cm	↑ cm	ltr.	
10415	25	58	10,5	inkl. Gestell / incl. stand

Ersatz-Deckel / replacement glass / cristal de recambio / vitre de rechange

	Ø cm	↑ cm
10418	14	12

Ersatz-Glas inklusive Deckel, ohne Zapfhahn / replacement glass with lid without tap / cristal de recambio con tapa sin grifo / vitre de rechange avec couvercle sans robinet

	Ø cm	↑ cm	ltr.
10417	25	42	10,5

Ersatz-Zapfhahn / replacement tap / grifo de recambio / robinet de rechange

10718

Ersatz-Gestell / stand / soporte de recambio / support de remplacement

	Ø cm	↑ cm
10416	26	19



4 ltr. / 6 ltr.
10870

Saftdispenser „BRIDGE“

juice dispenser
dispensador de zumo
distributeur à jus



Kühlung durch 2 Kühllakkus von oben und unten

cooling with 2 coolers from the top and base
2 acumuladores de frío: 1 en la base y 1 en la tapa
2 accumulateurs de froid: 1 dans le couvercle, 1 dans le socle

	cm	↑ cm	ltr.	Farbe / Colour
10870	31,0 x 20	42	4	
10871	35,5 x 22	50	6	



inklusive 3 Magnetschilder: ORANGE, APPLE, GRAPEFRUIT
including 3 magnetic signs: ORANGE, APPLE, GRAPEFRUIT



4 ltr. / 6 ltr.
10873

Saftdispenser „BRIDGE“

juice dispenser
dispensador de zumo
distributeur à jus



Kühlung durch 2 Kühllakkus von oben und unten

cooling with 2 cooling elements from the top and base
2 acumuladores de frío: 1 en la base y 1 en la tapa
2 accumulateurs de froid: 1 dans le couvercle et 1 dans le socle

	cm	↑ cm	ltr.	Farbe / Colour
10872	31,0 x 20	42	4	Wenge / wenge
10873	35,5 x 22	50	6	Wenge / wenge



inklusive 3 Magnetschilder: ORANGE, APPLE, GRAPEFRUIT
including 3 magnetic signs: ORANGE, APPLE, GRAPEFRUIT



Getränkespender „NORDIC WOOD“

beverage dispenser
dispensador de bebidas
distributeur de boissons



Behälter mit Edelstahlzapfhahn und Holzdeckel, stabiles Glas, inklusive weißem Holzstandfuß und Kork-Untersetzer

container with stainless steel tap and wooden cover, solid glas, including white wooden base and cork coaster

recipiente con grifo de acero inoxidable y tapa de madera, cristal sólido, pie de madera blanca y posavasos de corcho

réipient avec robinet en acier inox et covercle en bois, verre robuste, pied en bois blanc et soucoupes de liège

	cm	↑ cm	ltr.
10435	23 x 23	60,5	7,5

Trinkbecher „CRYSTAL“
drinking cup / vaso / gobelet



	Ø cm	↑ cm	ltr.	VE
10501	8	12,5	0,3	48

Ersatzteile Getränkspender „NORDIC WOOD“

parts beverage dispenser
recambios dispensador de bebidas
pièces distributeur de boissons

Ersatz-Deckel / replacement lid / tapa de recambio / couvercle de rechange

	Ø cm	↑ cm
10428	11,5	1,5

Ersatz-Glas inklusive Zapfhahn / replacement glass with tap / cristal de recambio con grifo / vitre de rechange avec robinet

	Ø cm	↑ cm	ltr.
10427	17	46	7,5

Ersatz-Untersetzer aus Kork / replacement cork coaster / posavasos de corcho de recambio / soucoupes de liège de rechange

	Ø cm	↑ cm
10424	16,5	1,5

Ersatz-Gestell / stand for / soporte de recambio / support de remplacement

	cm	↑ cm	Farbe / Colour
10426	23 x 23	14	



Getränkespender „FRESH WOOD“

beverage dispenser
dispensador de bebidas
distributeur de boissons



Behälter mit Edelstahlzapfhahn und Korkdeckel, stabiles Glas, inklusive Holzstandfuß und Kork-Untersetzer

container with stainless steel tap and cork cover, solid glas, including wooden base and cork coaster

recipiente con grifo de acero inoxidable y tapa de corcho, cristal sólido, pie de madera y posavasos de corcho

réipient avec robinet en acier inox et covercle de liège, verre robuste, pied en bois et soucoupes de liège

	cm	↑ cm	ltr.
10430	23 x 23	56,5	4,5

Trinkbecher „CRYSTAL“
drinking cup / vaso / gobelet



	Ø cm	↑ cm	ltr.	VE
10501	8	12,5	0,3	48

Tropfenschale / drip tray / aro anti-goteo / anneau coupe-gouttes



	Ø cm	↑ cm	Farbe / Colour
10851	9,5	1,5	White

Ersatzteile Getränkspender „FRESH WOOD“

spare parts beverage dispenser
recambios dispensador de bebidas
pièces distributeur de boissons

Ersatz-Deckel / replacement lid / tapa de recambio / couvercle de rechange

	Ø cm	↑ cm	Farbe / Colour
10428	11,5	1,5	Orange

Ersatz-Glas inklusive Zapfhahn / replacement glass with tap / cristal de recambio con grifo / vitre de rechange avec robinet

	Ø cm	↑ cm	ltr.
10422	15,5	42,0	4,5

Ersatz-Untersetzer aus Kork / replacement cork coaster / posavasos de corcho de recambio / soucoupes de liège de rechange

	Ø cm	↑ cm
10424	16,5	1,5

Ersatz-Gestell / stand for / soporte de recambio / support de remplacement

	cm	↑ cm	Farbe / Colour
10426	23 x 23	14	Orange



BEVERAGE DISPENSERS



Saftdispenser „TOWER“

juice dispenser
dispensador de zumo
distributeur à jus de fruit

aus Edelstahl, inklusive Crushed Ice Röhre

made of stainless steel, inclusive crushed ice tube
de acero inoxidable con tubo para hielo picado
en acier inox avec tube de glace pilée



	cm	↑ cm	ltr.
10440	35 x 23	75	5



Edelstahl Zapfhahn
stainless steel tap



Milchdispenser „BRIDGE“

milk dispenser
dispensador de leche
distributeur à lait

massives Buchenholz gebeizt, Edelstahldispenser mit 1 Kühlakku im Standfuß inklusive touchless adapter

solid beech wood, stained, stainless steel dispenser with 1 cooler in stand including touchless adapter

madera de haya maciza teñida, dispensador de acero inoxidable con 1 acumulador de frío en la base y con adaptador sin contacto para grifo

bois de hêtre massif teinté, distributeur en acier inox avec 1 accumulateur de froid dans le socle et avec adaptateur sans contact manuel



	cm	↑ cm	ltr.	Farbe / Colour
10837	31 x 20	39	3	■
10839	39 x 22	45	5	■



Milchdispenser „BRIDGE“

milk dispenser
dispensador de leche
distributeur à lait

massives Ahornholz, Edelstahldispenser mit 1 Kühlakku im Standfuß inklusive touchless adapter

solid maple wood, stainless steel dispenser with 1 cooler in stand including touchless adapter
madera maciza de arce, dispensador de acero inoxidable con 1 acumulador de frío en la base y con adaptador sin contacto para grifo

bois d'érable massif, distributeur en acier inox avec 1 accumulateur de froid dans le socle et avec adaptateur sans contact manuel



	cm	↑ cm	ltr.	Farbe / Colour
10836	31 x 20	39	3	■
10838	39 x 22	45	5	■



Milchkanne „TOP FRESH“

milk dispenser
dispensador de leche
distributeur à lait



hochglanzpoliert, 1 Kühlakku im Standfuß, „original Milchkanne mit Henkel“
mirror polished, 1 cooler in base, original milkcan
pulido brillante, 1 acumulador de frío en la base, recipiente „lechera“
poli brillant, 1 accumulateur de froid dans le socle, design „pot à lait“

	cm	↑ cm	ltr.
10830	21 x 32	39	3
10750	23 x 35	45	5

Milchkanne ohne Zapfhahn / milkcan without tap / jarra de leche sin grifo / récipient à lait sans robinet

	Ø cm	↑ cm	ltr.
10833	16	22	3
10663	22	26	5



Milchkanne „TOP FRESH“

milk dispenser
dispensador de leche
distributeur à lait



inklusive Porzellanschild zum Beschriften, 1 Kühlakku im Fuß
including porcelain sign, 1 cooler in base
incluye cartelito en porcelana, 1 acumulador de frío en la base
indicateur en porcelaine inclus, 1 accumulateur de froid dans le socle

	cm	↑ cm	ltr.
10850	31 x 21	42	4



Milchkanne „TOP FRESH“

milk dispenser
dispensador de leche
distributeur à lait



Buchenholz versiegelt, inklusive Porzellanschild zum Beschriften, 1 Kühlakku im Fuß
beech wood, waterproof, incl. porcelain sign, 1 cooler in base
madera de haya, resistente al agua, incluye placa de porcelana, 1 acumulador de frío en la base
socle bois hêtre traité, indicateur en porcelaine inclus, 1 accumulateur de froid dans le socle

	cm	↑ cm	ltr.
10840	23 x 32,0	42	4
10757	27 x 38,5	45	8

BEVERAGE DISPENSERS



Saftdispenser „TOP FRESH“

juice dispenser
dispensador de zumo
distributeur à jus de fruit



hochglanzpoliert, Kühlung durch 2 Kühllakkus von oben und unten
mirror polished, cooling with 2 cooling elements from the top and base

pulido brillante, con 2 acumuladores de frío, 1 arriba y 1 en la base
poli brillant, 2 accumulateurs de froid, 1 dans le couvercle, 1 dans le socle

	cm	↑ cm	ltr.
10800	21 x 32	43	4
10700	23 x 35	52	6



Saftdispenser DUO „TOP FRESH“

juice dispenser
dispensador de zumo
distributeur à jus de fruit



hochglanzpoliert, Kühlung durch 2 Kühllakkus von oben und unten

mirror polished, cooling with 2 cooling elements from the top and base

pulido brillante, con 2 acumuladores de frío, 1 arriba y 1 en la base
poli brillant, 2 accumulateurs de froid, 1 dans le couvercle, 1 dans le socle

	cm	↑ cm	ltr.
10720	42 x 32	52	2 x 6



Saftdispenser „INOX STAR“

juice dispenser
dispensador de zumo
distributeur à jus de fruit



Edelstahl-Crushed Ice Röhre herausnehmbar

removable stainless steel crash ice tube
con tubo inox refrigerante extraíble para hielo picado
avec tube inox réfrigérant amovible pour glace pilée

	cm	↑ cm	ltr.
10795	36 x 26	55	8

Behälter / container / recipiente / récipient

	Ø cm	ltr.
10796	22	8



Iso-Dispenser

insulated dispenser
dispensador isotérmico
distributeur de boisson isothermique



für heiße und kalte Getränke

for hot and cold drinks
para bebidas frías y calientes
pour boissons chaudes ou froides

	Ø cm	↑ cm	ltr.
10788	24	42	9,5

Hahn / tap / grifo / robinet

10789			
-------	--	--	--

einklappbare Füße
foldable feet



1) Deckel / cover / tapa / couvercle

für ltr. / for ltr. / para ltr. / pour ltr.

10701	6
10801	4

2) Kühlakku / cooler / acumulador de frío / accumulateur de froid

für ltr. / for ltr. / para ltr. / pour ltr.

10777	4 / 6
-------	-------

3) Behälter inklusive Zapfhahn / container incl. tap
recipiente con grifo / récipient avec robinet

für ltr. / for ltr. / para ltr. / pour ltr.

10703	6
10803	4

3) Behälter ohne Zapfhahn / container without tap
recipiente sin grifo / récipient sans robinet

für ltr. / for ltr. / para ltr. / pour ltr.

10704	6
10804	4

4) Non-Drip Hahn / non-drip tap / grifo anti-goteo / robinet anti-goutte

für ltr. / for ltr. / para ltr. / pour ltr.

10707	6
10807	4

5) Einsatz / insert / aro inox / cercle inox

für ltr. / for ltr. / para ltr. / pour ltr.

10708	6
10808	4

6) Standfuß 18/10 Edelstahl / column 18/10 stainless steel
base inox 18/10 / socle inox 18/10

für ltr. / for ltr. / para ltr. / pour ltr.

10709	6
10809	4

7) Tropfgitter 18/10 Edelstahl / drip lattice 18/10 stainless steel
rejilla recoge gotas 18/10 / grille ramasse-gouttes 18/10

für ltr. / for ltr. / para ltr. / pour ltr.

10712	6
10713	DUO
10812	4

8) Bodenplatte 18/10 Edelstahl / footing 18/10 stainless steel
base de 18/10 acero / socle inox 18/10

für ltr. / for ltr. / para ltr. / pour ltr.

10710	6
10711	DUO / 6 + 6
10814	4

1 x Dichtung, 2 x Dichtungsring (transparent), 1 x Dichtungsring (s / w)
1 x seal, 2 x sealing ring (transparent), 1 x sealing ring (b / w)

Zubehör / Reinigungsset - für die regelmäßige Reinigung

10714	für Zapfhahn 10707
10715	für Zapfhahn 10807
10716	für Zapfhahn 10907
10717	für Zapfhahn 10867



BEVERAGE DISPENSERS

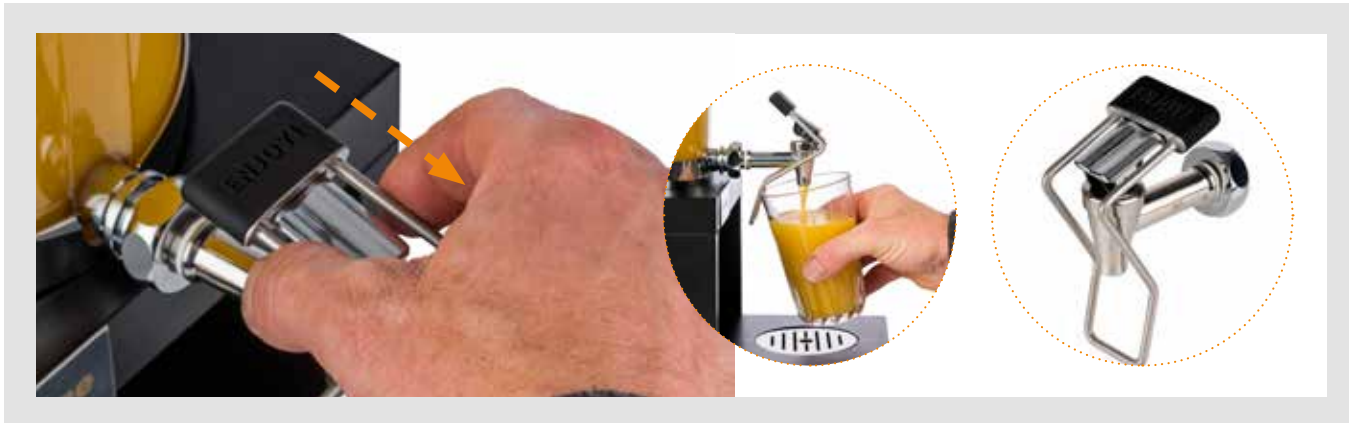

Der Adapter passt auf alle Dispenser der Serien TOP FRESH, BRIDGE und SUNDAY und kann ganz einfach installiert werden.

The adapter fits all dispensers of the series TOP FRESH, BRIDGE and SUNDAY and can be installed very easily.

El adaptador se adapta a todos los dispensadores de las series TOP FRESH, BRIDGE y SUNDAY y puede ser instalado fácilmente.

L'adaptateur s'adapte à tous les distributeurs des séries TOP FRESH, BRIDGE et SUNDAY et peut être installé très facilement.



Adapter „TOP FRESH“

adapter
adaptador
adaptateur

EDELSTAHL
STAINLESS
INOX
18/8

SILIKON
SILICON



handkontaktloser Adapter, einfach zu installieren

adapter touchless for tap, easy to install

adaptador sin contacto para grifo

adaptateur sans contact manuel, facile à installer

	cm	↑ cm
10802	12 x 4,5	5,5



Einfach den Adapter an der dafür vorgesehenen Öffnung auf den Hebel des Zapfhahns stecken.

Simply plug the adapter onto the lever of the tap at the opening provided.



Anschließend den Adapter nach unten festziehen. Durch das Nachvorne-Drücken des unteren Edelstahlbügels mit Hilfe des Glases, wird der Hebel des Zapfhahns betätigt und das Getränk fließt völlig handkontaktlos in das Glas.

Then tighten the adapter downwards. By pushing the lower stainless steel bracket forward with the help of the glass, the lever of the tap is activated and the drink flows into the glass completely without hand contact.

passend für / suitable for:



10700
6 ltr.

Saftdispenser „TOP FRESH“
Katalog Seite 118
juice dispenser,
catalogue page 118



10830
3 ltr.

Milchkanne „TOP FRESH“
Katalog Seite 117
milk dispenser,
catalogue page 117

NEW

DRINKING BOTTLES



NEW



66907 0,55 ltr



66908 0,75 ltr



66909 1 ltr

Trinkflasche
drinking bottle
botella para beber
gourde

Glas mit Schraubverschluss aus 18/8 Edelstahl
screw cap made of 18/8 stainless steel
tapón de rosca de 18/8 acero inoxidable
bouchon à vis en 18/8 acier inox

GLAS
GLASS

EDELSTAHL
STAINLESS
INOX
18/8

PP
POLYPROPYLEN

SILIKON
SILICON



	∅ cm	↑ cm	ltr.
66907	6,5	23,5	0,55
66908	7	26,5	0,75
66909	7,5	28,5	1



66907

66908

66909



...immer dabei



mit Schraubverschluss
with screw cap

66907

0,55 ltr

66908

0,75 ltr

66909

1 ltr

CARAFES



Glaskaraffe

glass carafe
jarra de vidrio
pichet en verre



der Deckel öffnet sich beim Ausgießen automatisch
cover opens automatically while pouring
la tapa se abre automáticamente durante el vertido
le couvercle s'ouvre seul pendant le service

	Ø cm	↑ cm	ltr.
10766	9,5	29	1



Saft- / Wasserkanne

juice / water pitcher
jarra de zumo / agua
pichet à eau ou jus de fruit



Deckel aus Edelstahl matt poliert, Ausgießer für tropffreies Ausgießen
stainless steel cover, matt polished, spout for drip-free pouring
tapa de acero inoxidable pulido mate, pico para verter sin gotear
couvercle en acier inox poli mat, bec verseur pour verser sans goutter

	Ø cm	↑ cm	ltr.
10764	9,5	27	1,5



Saft- / Wasserkanne

juice / water pitcher
jarra de zumo / agua
pichet à eau ou jus de fruit



Deckel aus Edelstahl matt poliert, mit integriertem Auffangsieb für Kerne oder Eis
lid made of matt polished stainless steel, with integrated strainer for cores or ice
tapa de acero inoxidable pulido mate, con filtro integrado para los huesos o el hielo
couvercle en acier inox poli mat, avec filtre intégré pour les pépins ou la glace

	Ø cm	↑ cm	ltr.
10792	10	26	1,5

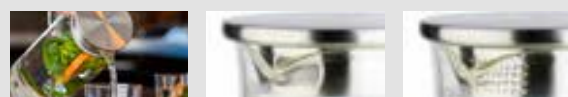

Deckel mit Doppelfunktion
lid with double function



Podest für Glaskaraffe
 pedestal for glass carafe
 pedestal para jarra de vidrio
 podium pour pichet en verre



Eichenholz (wasserfest lackiert)
 oak wood (waterproof lacquered)
 madera de roble (lacado impermeable)
 bois de chêne (vernis imperméable)

	cm	↑ cm	fits to
14019	15 x 15	12	10738, 10739, 10741, 10742, 10721, 10722

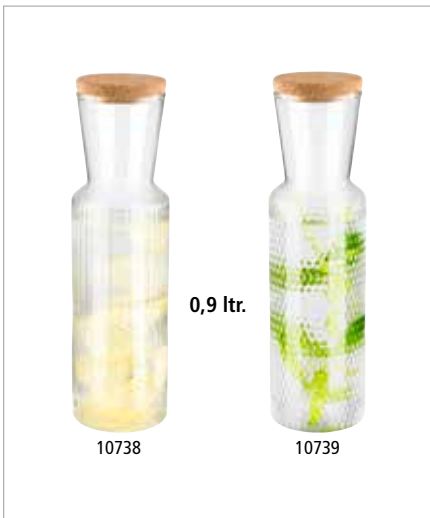

Glaskaraffe
 glass carafe
 jarra de vidrio
 carafe en verre



	Ø cm	↑ cm	ltr.	Design
10738	8	27	0,9	LINES
10739	8	27	0,9	DOTS



Detailansicht
 detail view „LINES“



Detailansicht
 detail view „DOTS“



inklusive Korkdeckel
 incl. cork cover



Glaskaraffe
 glass carafe
 jarra de vidrio
 carafe en verre



	Ø cm	↑ cm	ltr.	Design
10741	8	28	0,8	COMB
10742	8	28	0,8	DIAMOND



Detailansicht
 detail view „COMB“



Detailansicht
 detail view „DIAMOND“



inklusive Holzkorken mit Silikondichtung
 including wooden cork with silicone gasket



Glaskaraffe
 glass carafe
 jarra de vidrio
 carafe en verre



Deckel aus Edelstahl matt poliert, Ausgießer für tropffreies Ausgießen
 lid made of matt polished stainless steel, spout for drip-free pouring
 tapa de acero inoxidable pulido mate, pico para verter sin gotear
 couvercle en acier inox poli mat, bec verseur pour verser sans goutter

	Ø cm	↑ cm	ltr.
10721	8	25	1,0
10722	8	32	1,3

CARAFES



1,8 ltr.

Saft- / Wasserkanne

juice / water pitcher
jarra de zumo / agua
pichet à eau ou jus de fruit



Deckel mit Auffangsieb für Kerne oder Eis

lid with integrated strainer for cores or ice
tapa con filtro integrado para los huesos o el hielo
couverture avec filtre intégré pour les pépins ou la glace

	Ø cm	↑ cm	ltr.
10691	12	26	1,8



2 tlg.
2 pcs.

1,0 ltr.

300 ml

Glaskaraffe „OLD FASHIONED“, 2 teilig

glass carafe, 2 pcs.
jarra de vidrio, set de 2
carafe en verre, set de 2



1 Flasche 1,0 ltr., 1 Glas 0,3 ltr.

1 bottle 1,0 ltr., 1 glass 0,3 ltr.

1 botella 1,0 ltr., 1 vaso 0,3 ltr.

1 bouteille 1,0 ltr., 1 verre 0,3 ltr.

	Ø cm	↑ cm	ltr.
10690	9,5	31	1,0

Ersatzglas / replacement glass / vaso de recambio / verre de remplacement

	Ø cm	↑ cm	ltr.	VE / unit
10520	8	12,5	0,3	6



11705

11706

Buffetbrett

buffet board
tabla de buffet
planche de buffet



für Karaffen, mit 3 Einsätzen Ø 11 cm aus Kunstleder, aus geöltem Eichenholz

for carafes, with 3 leatherette inserts Ø 11 cm, made of oiled oak wood

para jarras, con 3 inserciones de imitación de cuero Ø 11 cm, de madera de roble aceitada

pour pichets, avec 3 inserts en similicuir Ø 11 cm, en bois de chêne huilé

	cm	↑ cm	Farbe / Colour
11705	47 x 19	2	 natural oak
11706	47 x 19	2	 dark oak

6 Einsätze aus Kunstleder / 6 leatherette inserts / 6 inserciones de imitación de cuero / 6 inserts en similicuir

	Ø cm	Farbe / Colour	pcs.
35716	11	 anthracite	6



Kunstledereinsatz herausnehmbar
removable leatherette insert



3,0 ltr.

Saft- / Wasserkanne

juice / water pitcher
jarra de zumo / agua
pichet à eau ou jus de fruit



mit Eiswasserröhre

with water ice tube

con tubo para hielo

avec tube à glaçons plongeant pour réfrigérer



	Ø cm	↑ cm	ltr.
10770	18	29	3

NEW



10692 1 ltr.

Soft- / Wasserkanne

juice / water pitcher
jarra de zumo / agua
pichet à jus de fruit / eau

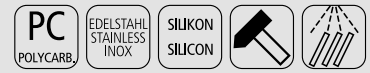

Deckel aus Edelstahl mit Silikondichtung, mit integriertem Auffangsieb für Kerne oder Eis

stainless steel lid with silicone seal, with integrated strainer for cores or ice
tapa de acero inoxidable con junta de silicona, con filtro integrado para los huesos o el hielo
couvercle en acier inox avec joint en silicone, avec filtre intégré pour les pépins ou la glace

	Ø cm	↑ cm	ltr.
10692	10	19	1
10693	11,5	24	1,8



Deckel mit Doppelfunktion
lid with double function



2,8 ltr.

Soft- / Wasserkanne

juice / water pitcher
jarra de zumo / agua
pichet à eau ou jus de fruit



mit Eiswasserröhre / with water ice tube / con tubo para hielo / avec tube d'eau glacée

	cm	↑ cm	ltr.
10769	19 x 13	27	2,8



10775 2,0 ltr. 10776 2,5 ltr.

Soft- / Wasserkanne

juice / water pitcher
jarra de zumo / agua
pichet à eau ou jus de fruit



	Ø cm	↑ cm	ltr.
10775	12	26	2
10776	14	29	2,5



1,6 ltr.

Karaffe

bottle
botella
bouteille



Schraubdeckel mit aromadichtem Verschluss

screwed lid, aroma-tight
tapón de rosca, impide la fuga de aromas
bouchon à visser, ne laisse pas passer les arômes

	Ø cm	↑ cm	ltr.	Farbe / Colour
10771	11	30	1,6	



10748 1 ltr. 10749 1 ltr.

Flaschenverschluss
bottle top

Flasche „STRIPES“

bottle
botella
bouteille



	Ø cm	↑ cm	ltr.	Farbe / colour
10748	9	28,5	1	
10749	9	28,5	1	

BEVERAGE BOWLS



Pitcher
pitcher
jarra
pichet



	Ø cm	↑ cm	ltr.
93090	12,5	17,5	1,0
93091	13,5	20,0	1,5

passende Deckel / fitting lids / tapa adecuadas / couvercles appropriées

	cm	↑ cm	fits to
93092	13,0	1,5	93090
93093	14,0	1,5	93091



Deckel mit Klappe
lid with flap



einfaches Ausgießen
easy pouring out



stapelbar
stackable



Pitcher
pitcher
jarra
pichet



	Ø cm	↑ cm	ltr.
93105	13	21	1,5



Kühlbox „FROSTY“
bottle cooler
enfriador de botellas
rafraichisseur de bouteilles



mit herausnehmbarem Einsatz für 4 Flaschen
with removable insert for 4 bottles
con inserto extraíble para 4 botellas
avec insert amovible pour 4 bouteilles



Abb. ohne Einsatz
illustration without insert

	cm	↑ cm	ltr.	hole ø cm
93230	27 x 27	15	7,5	11



Flaschenkühler „BIG BOWL“
bottle cooler
enfriador de botella
rafraichisseur de bouteille



gehämmerte Oberfläche, innen mattiert, herausnehmbarer Tropfeinsatz
hammered surface, matted inside, removable drip tray
superficie martillada, interior mate, bandeja de goteo extraíble
surface martelée, intérieur mat, bac de récupération amovible

	Ø cm	↑ cm	ltr.
36130	37	23	8





36111 7 ltr.

36112 7 ltr.

Wein- / Sektkühler „XL“

wine / champagne bowl
cubitera para vino y cava
seau à vin ou champagne

gehämmerte Oberfläche, mit 2 seitlichen Eingriffen

hammered surface, with 2 handles on the side

superficie martillada, con 2 asas

surface martelée, avec 2 poignées



	cm	↑ cm	ltr.	Farbe / Colour
36111	30 x 23,5	23	7	copper-look
36112	30 x 23,5	23	7	gunmetal-look



36109 3,9 ltr.

36108 3,9 ltr.

Wein- / Sektkühler „LARGE“

wine / champagne bowl
cubitera para vino y cava
seau à vin ou champagne

gehämmerte Oberfläche, mit 2 seitlichen Eingriffen, für 1-2 Flaschen

hammered surface, with 2 handles on the side, for 1-2 bottles

superficie martillada, con 2 asas, para 1-2 botellas

surface martelée, avec 2 poignées, pour 1-2 bouteilles



	cm	↑ cm	ltr.	Farbe / Colour
36108	25,5 x 19	20	3,9	copper-look
36109	25,5 x 19	20	3,9	gunmetal-look



36106 2,1 ltr.

36107 2,1 ltr.

Wein- / Sektkühler „SMALL“

wine / champagne bowl
cubitera para vino y cava
seau à vin ou champagne

gehämmerte Oberfläche, für 1 Flasche

hammered surface, for 1 bottle

superficie martillada, para 1 botella

surface martelée, pour 1 bouteille



	cm	↑ cm	ltr.	Farbe / Colour
36106	20,5 x 14	17	2,1	copper-look
36107	20,5 x 14	17	2,1	gunmetal-look



36100 11 ltr.

36095 11 ltr.

Getränkewanne „TIN“

beverage tub
barreño botellines
bassine à glace

Metall verzinkt, mit Kunststoffeinsatz

galvanised metal, with plastic insert

metal galvanizado, con inserto de plástico

métal galvanisé, avec insert en plastique



	cm	↑ cm	ltr.	Farbe / Colour
36100	40 x 28	22	11	copper-look
36101	40 x 28	22	11	black-metal-look
36095	40 x 28	22	11	metal-look
36096	50 x 23	23	18	metal-look



mit Kunststoffeinsatz
with plastic insert
con inserto de plástico
avec insert en plastique



71490

Kreidestift zum
Beschriften | chalk
marker for writing
S. 346

CONFERENCE



Flaschenkühler „CONFERENCE“

conference bottle cooler
enfriador múltiple
rafraîchisseur



inklusive Kühllakku, Flaschenöffner, Kronkorkenschale,
mit 6 Öffnungen Ø 6,7 cm für 0,25 - 0,5 Liter-Flaschen

incl. bottle cooler, bottle opener, small cap bowl,
with 6 holes Ø 6,7 cm for 0,25 to 0,5 liter bottles

con acumulador de frío, abridor, recuperador de chapas,
6 plazas Ø 6,7 cm, para botellas de 0,25 a 0,5 ltr.

avec accumulateur de froid, décapsuleur, bol récupérateur
de capsules, 6 places Ø 6,7 cm, pour bouteilles de 0,25 à 0,5 litres

	Ø cm	↑ cm	Farbe / Colour
00620	23	15	■
00621	23	15	■



Kühllakku

cooler
acumulador de frío
accumulateur de froid



	Ø cm	→ cm	Farbe / Colour
00615	7,5	11,5	■



Flaschenöffner

bottle opener
abridor
décapsuleur



	Ø cm	→ cm
00617	1	13,5



Kronkorkenschale

cap bowl
cuenco para chapas
bol récupérateur de capsules



	Ø cm	↑ cm	Farbe / Colour
00618	6,5	3	■
00619	6,5	3	■



10,5 ltr.

Kaffeedispenser „HAPPY HOUR“

coffee dispenser
dispensador de café
distributeur de café



hochglanzpoliert, für warme Getränke, stabil und standfest, inklusive 1 Brennpastenbehälter
mirror polished, for warm drinks, solid and stable, including 1 burner holder
pulido brillante, para bebidas calientes, sólido y estable, incluye un calentador
poli brillant, pour boissons chaudes, robuste et stable, avec 1 brûleur

	cm	↑ cm	ltr.
11672	31 x 33,5	54,5	10,5

Hahn / tap / grifo / robinet

11671

Elektro-Heizelement / heating unit / resistencia / résistance

	cm	↑ cm
12287	21 x 20	6



Pump-Isolierkanne „PREMIUM“

air pot
jarra termo
bouteille isotherme



matt poliert, doppelwandig, Tragegriff, Drehverschluss, Pumpmechanismus, Füllstandsanzeigefür heiße und kalte Getränke, inklusive 4 Beschriftungsclips, für 24 Tassen

matt polished, double-walled, carrying handle, screw cap, pump mechanism, fill level indicator, for hot and cold beverages, including 4 beverage signs, for 24 cups

pulido mate, doble pared, asa de transporte, tapón de rosca, mecanismo de bombeo, indicador de nivel para bebidas calientes y frías, con 4 clips para marcar, para 24 tazas

poli mat, double paroi, poignée de transport, fermeture rotative, mécanisme de pompage, indicateur de niveau pour boissons chaudes et froides, avec 4 clips d'inscriptions, pour 24 tasses

	Ø cm	↑ cm	ltr.	Anzahl der Tassen
10916	15	37	3	24

Tropfenfänger für Pump-Isolierkanne / drip tray for air pot / recoge-gotas para jarra termo / ramasse-gouttes pour bouteilles isotherme

	cm	↑ cm
10917	24 x 18,5	4



Pump-Isolierkanne „BUDGET“

air pot
jarra termo
bouteille isotherme



Edelstahl, Polypropylen, matt poliert, doppelwandig, Tragegriff, Dreh-Pumpknopf, für heiße und kalte Getränke, für 17 Tassen

stainless steel, polypropylene, matt polished, double-walled, carrying handle, push-button, for hot and cold beverages, for 17 cups

acero inoxidable, polipropileno, pulido mate, doble pared, asa de transporte, botón giratorio de la bomba, para bebidas calientes y frías, para 17 tazas

acier inox, polypropylène, poli mat, double paroi, poignée de transport, bouton de pompage rotatif, pour boissons chaudes et froides, pour 17 tasses

	Ø cm	↑ cm	ltr.	Anzahl der Tassen
10915	13,5	32,5	2,2	17

VACUUM JUGS



Isolierkanne „ADVANCED“

vacuum jug
jarra termo
bouteille isotherme



doppelwandig, spülmaschinenfest, Einhandautomatik, aufgeklappt passt die Kanne unter die gängigen Kaffeeautomaten, für heiße und kalte Getränke

double-walled, dishwasher-safe, easy pouring system, with flipped-back lid, the air pot fits under a wide range of coffee makers, for hot and cold beverages

doble pared, resistente al lavavajillas, se maneja con 1 mano, con la tapa abierta la jarra se puede usar con casi todas las cafeteras corrientes, para bebidas frías y calientes

double paroi, résistante au lave-vaisselle, usage à 1 main, avec la couvercle ouverte a

bouteille se peut user avec toutes les machines à café courantes, pour boissons chaudes ou froides

	Ø cm	↑ cm	ltr.	Anzahl der Tassen
10921	10,5	13,0	0,3	2,5
10922	10,5	18,0	0,6	5,0
10923	13,0	19,5	1,0	8,0
10924	13,0	23,5	1,5	12,0



Deckel klappbar
lid foldable



Isolierkanne „VEGAN ADVANCED“

vacuum jug
jarra termo
bouteille isotherme



doppelwandig, spülmaschinenfest, Einhandautomatik, aufgeklappt passt die Kanne unter die gängigen Kaffeeautomaten, für heiße und kalte Getränke, mit Gravur „VEGAN“

double-walled, dishwasher-safe, easy pouring system, with flipped-back lid, the air pot fits under a wide range of coffee makers, for hot and cold beverages, with engraving „VEGAN“

doble pared, resistente al lavavajillas, se maneja con 1 mano, con la tapa abierta la jarra se puede usar con casi todas las cafeteras corrientes, para bebidas frías y calientes, con grabado „VEGAN“

double paroi, résistante au lave-vaisselle, usage à 1 main, avec la couvercle ouverte a bouteille se peut user avec toutes les machines à café courantes, pour boissons chaudes ou froides, avec gravure „VEGAN“

	Ø cm	↑ cm	ltr.	Anzahl der Tassen
10353	10,5	18,0	0,6	5,0
10354	13,0	19,5	1,0	8,0



10912 2,0 ltr.

Isolierkanne „CLASSIC“

vacuum jug
jarra termo
bouteille isotherme



doppelwandig, Einhandautomatik, Drehverschluss, für heiße und kalte Getränke

double-walled, easy push-button pouring system, screw cap, for hot and cold drinks
doble pared, se maneja con 1 mano, con tapa a rosca, para bebidas frías y calientes
double paroi, usage à 1 main, couvercle à visser, pour boissons chaudes ou froides

	Ø cm	↑ cm	ltr.	Anzahl der Tassen
10910	14	19	1,0	8
10911	14	22	1,5	12
10912	14	25	2,0	16



Isolierkanne „VEGAN CLASSIC“

vacuum jug
jarra termo
bouteille isotherme



doppelwandig, Einhandautomatik, Drehverschluss, für heiße und kalte Getränke

double-walled, easy push-button pouring system, screw cap, for hot and cold drinks
doble pared, se maneja con 1 mano, con tapa a rosca, para bebidas frías y calientes
double paroi, usage à 1 main, couvercle à visser, pour boissons chaudes ou froides

	Ø cm	↑ cm	ltr.
10352	14	19	1,0

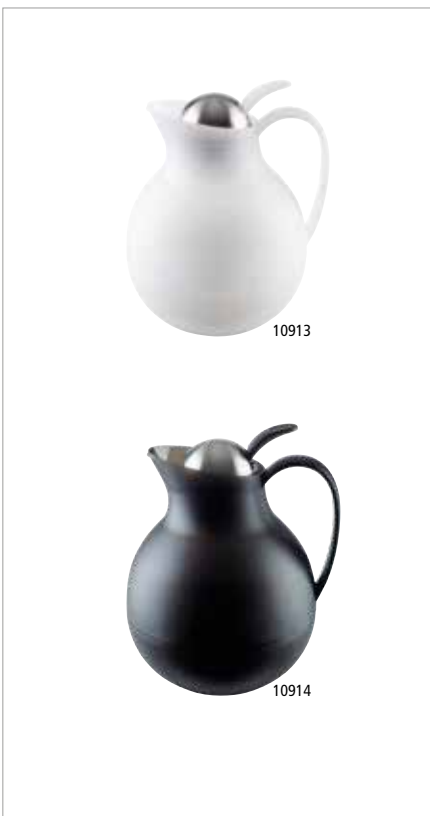

10913

10914

Isolierkanne „ECONOMY“

vacuum jug
jarra termo
bouteille isotherme



robuste Umhüllung mit Polypropylen-Kunststoff, Stabilglaseinsatz, Drehverschluss mit Drucktasten-Bedienung für heiße und kalte Getränke, 8 Tassen

double-walled with glass liner, screw cap with easy push-button pouring system, for hot and cold beverages, 8 cups

exterior de plástico polipropileno, interior aislante de vidrio, con tapa a rosca con cierre dosificador para bebidas frías y calientes, 8 tazas

extérieur en plastique polypropylène, intérieur avec plaque de verre, couvercle à visser, pour boissons chaudes ou froides, 8 tasses

	Ø cm	↑ cm	ltr.	Farbe / Colour
10913	16	20	1	White
10914	16	20	1	Black

TEAPOTS



Teekanne „ASIA“

teapot
tetera
théière



aus Gusseisen, innen emailliert, abnehmbarer Deckel, mit Teesieb aus Edelstahl

made of cast iron, enamelled inside, removable lid, with tea strainer made of stainless steel
hierro fundido, interior esmaltado, tapa extraíble, con colador de té de acero inoxidable
en fonte, émaillé à l'intérieur, couvercle amovible, avec une passoire à thé en acier inox

	cm	↑ cm	ltr.	Farbe / Colour
10995	17 x 14	17	0,8	■
10996	17 x 14	17	0,8	■



Teekanne „ASIA“

teapot
tetera
théière



aus Gusseisen, innen emailliert, abnehmbarer Deckel, mit Teesieb aus Edelstahl

made of cast iron, enamelled inside, removable lid, with tea strainer made of stainless steel
hierro fundido, interior esmaltado, tapa extraíble, con colador de té de acero inoxidable
en fonte, émaillé à l'intérieur, couvercle amovible, avec une passoire à thé en acier inox

	cm	↑ cm	ltr.	Farbe / Colour
10991	19,5 x 18	15	0,8	■
10992	19,5 x 18	15	0,8	■



Teekanne „ASIA“

teapot
tetera
théière



aus Gusseisen, innen emailliert, mit abnehmbarem Deckel, ohne Teesieb aus Edelstahl
made of cast iron, enamelled inside, with removable lid, without tea strainer made of stainless steel

hierro fundido, interior esmaltado, con tapa extraíble, sin colador de té de acero inoxidable
en fonte, émaillé à l'intérieur, avec couvercle amovible, sans une passoire à thé en acier inox

	cm	↑ cm	ltr.	Farbe / Colour
10990	12,5 x 11	12,5	0,3	■



10994



10993

Stövchen „ASIA“

teapot warmer
calentador de tetera
chauffe-théière



1-flammiges Stövchen aus Gusseisen mit abnehmbarem Deckel (Lieferung ohne Teelicht).

1-flame cast iron warmer with removable lid (delivery without tealight).

calentador de tetera de hierro fundido con 1 quemador con tapa extraíble (se entrega sin vela).

chauffe-théière en fonte à 1 brûleur avec couvercle amovible (livraison sans bougie).

	Ø cm	↑ cm	Farbe / Colour
10994	13	7,5	■

Untersetter aus Gusseisen mit Antirutschfüßchen / cast iron coaster with non-slip feet

	Ø cm	↑ cm	Farbe / Colour
10993	13,5	1,5	■



11575

Teebox

tea-box
caja para té
boîte à thés et infusions



Box aus Rubberwood mit Sichtfenster, mit Aufschrift „Tee“, 4 Kammern können mit je 30 kuvertierten Teebeuteln bestückt werden

rubber wood box with clear transparent window, with inscription „Tee“, 4 chambers for approx. 30 tea bags each

caja de madera de goma clara con ventana transparente, con inscripción „Tee“, 4 compartimentos, y cada uno para aproximadamente 30 bolsitas de té

en bois d'hévéa clair avec fenêtre, avec inscription „Tee“, 4 compartiments, pour environ 30 sachets chacun

	cm	↑ cm	Farbe / Colour
11575	33,5 x 20	9	■
11574	33,5 x 20	9	■

	cm	↑ cm	Farbe / Colour	
11576	33,5 x 20	9	■	ohne Aufschrift / without inscription sin inscripción / sans inscription



11776

Teebox

tea-box
caja para té
boîte à thés et infusions



Box aus Rubberwood mit Sichtfenster, mit Aufschrift „Tee“, 12 Kammern können mit je 12 kuvertierten Teebeuteln bestückt werden

rubber wood box with clear transparent window, with inscription „Tee“, 12 chambers for approx. 12 tea bags each

caja de madera de goma clara con ventana transparente, con inscripción „Tee“, 12 compartimentos, y cada uno para aproximadamente 12 bolsitas de té

en bois d'hévéa clair avec fenêtre, avec inscription „Tee“, 12 compartiments, pour environ 12 sachets chacun

	cm	↑ cm	Farbe / Colour
11775	31 x 28	9	■
11776	31 x 28	9	■

**Teebox / Multibox**

tea caddy
caja para té
boîte à thés et infusions



3 Fächer für kuvertierte Teebeutel, 1 Fach für Zucker, Kekse, etc., Deckel aufklappbar

3 compartments for tea bags, 1 compartment for sugar, biscuits, etc., hinged lid

3 compartimentos para bolsitas de té, 1 compartimento para azúcar, galletas, etc. tapa abatible

3 compartiments pour sachets de thé, 1 compartiment pour sucre, biscuits, etc., couvercle abatible

	cm	↑ cm
11563	22 x 17	9

NEW SAMOWAR

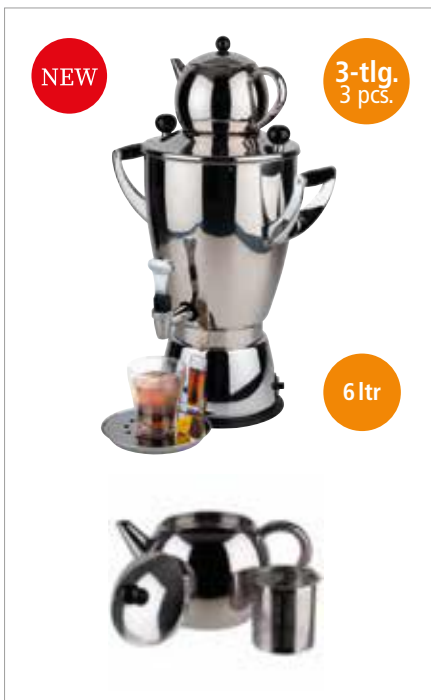

Samovar

samovar
samovar
samovar



3-teiliges Set:

- 1 Samovar, 230V, 50/60Hz, 1.800W (6 Liter)
- 1 Teekanne (1,1 Liter)
- 1 Tropfenschale

3 pcs. set:

- 1 samovar, 230V, 50/60Hz, 1.800W (6 ltr.)
- 1 teapot (1,1 ltr.)
- 1 drip tray

set de 3:

- 1 samovar, 230V, 50/60Hz, 1.800W (6 L.)
- 1 tetera (1,1 L.)
- 1 bandeja recogegotas

set de 3:

- 1 samovar, 230V, 50/60Hz, 1.800W (6 L.)
- 1 théière (1,1 L.)
- 1 bac ramasse-gouttes

	cm	↑ cm	ltr.
12315	35 x 21	58	6

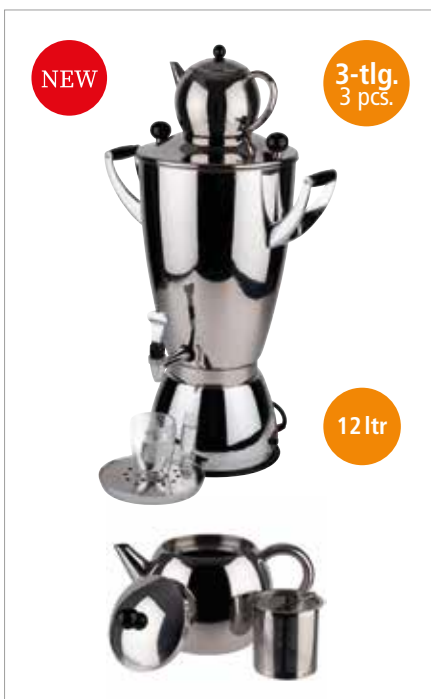

Samovar

samovar
samovar
samovar



3-teiliges Set:

- 1 Samovar, 230V, 50/60Hz, 1.800W (12 Liter)
- 1 Teekanne (1,3 Liter)
- 1 Tropfenschale

3 pcs. set:

- 1 samovar, 230V, 50/60Hz, 1.800W (12 ltr.)
- 1 teapot (1,3 ltr.)
- 1 drip tray

set de 3:

- 1 samovar, 230V, 50/60Hz, 1.800W (12 L.)
- 1 tetera (1,3 L.)
- 1 bandeja recogegotas

set de 3:

- 1 samovar, 230V, 50/60Hz, 1.800W (12 L.)
- 1 théière (1,3 L.)
- 1 bac ramasse-gouttes

	cm	↑ cm	ltr.
12316	42 x 26	75	12

NEW TWINZ



NEW



„espresso size“

Gläser, 2er Set „TWINZ“

glasses, 2 pcs. set
vasos, set de 2
verres, set de 2

doppelwandig, ideal für Espresso

glass, double-walled, ideal for espresso
vidrio, doble pared, ideal para espresso
verre, à double paroi, idéal pour l'espresso

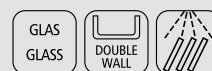

	Ø cm	↑ cm	ltr.	pcs.
10370	6	6,5	0,08	2

NEW



„coffee and tea size“

Gläser, 2er Set „TWINZ“

glasses, 2 pcs. set
vasos, set de 2
verres, set de 2

doppelwandig, ideal für Kaffee oder Tee

glass, double-walled, ideal für coffee or tea
vidrio, doble pared, ideal para café o té
verre, à double paroi, idéal pour le café ou le thé

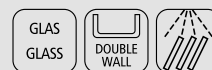

	Ø cm	↑ cm	ltr.	pcs.
10371	8,5	8,5	0,23	2

NEW



„latte macchiato size“

Gläser, 2er Set „TWINZ“

glasses, 2 pcs. set
vasos, set de 2
verres, set de 2

doppelwandig, ideal für Latte Macchiato

glass, double-walled, ideal for Latte Macchiato
vidrio, doble pared, ideal para latte macchiato
verre, à double paroi, idéal pour le latte macchiato

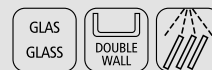

	Ø cm	↑ cm	ltr.	pcs.
10372	8,5	14	0,38	2

NEW SNUG



Espressotasse „SNUG“

espresso cup
taza de espresso
tasse à espresso



Porzellan, Griff: 2 cm / porcelain, handle: 2 cm / porcelana, asa: 2 cm / porcelaine, poignée: 2 cm

	Ø cm	↑ cm	ltr.	Farbe / Colour	VE / unit
16000	6	5,5	0,08		6
16001	6	5,5	0,08		6
16002	6	5,5	0,08		6



Espressountertasse „SNUG“

espresso saucer
platillo de espresso
soucoupe à espresso



Porzellan / porcelain / porcelana / porcelaine

	Ø cm	↑ cm	Farbe / Colour	VE / unit
16009	11,5	2		6
16010	11,5	2		6
16011	11,5	2		6





Kaffeetasse „SNUG“

coffee cup
taza de café
tasse à café



Porzellan, Griff: 2 cm / porcelain, handle: 2 cm / porcelana, asa: 2 cm / porcelaine, poignée: 2 cm

	Ø cm	↑ cm	ltr.	Farbe / Colour	VE / unit
16003	9,5	6	0,2		6
16004	9,5	6	0,2		6
16005	9,5	6	0,2		6



Kaffeuntertasse „SNUG“

coffee saucer
platillo de café
soucoupe à café



Porzellan / porcelain / porcelana / porcelaine

	Ø cm	↑ cm		Farbe / Colour	VE / unit
16012	14,5	2,5			6
16013	14,5	2,5			6
16014	14,5	2,5			6



Cappuccinotasse „SNUG“

cappuccino cup
taza de cappuccino
tasse à cappuccino



Porzellan, Griff: 3 cm / porcelain, handle: 3 cm / porcelana, asa: 3 cm / porcelaine, poignée: 3 cm

	Ø cm	↑ cm	ltr.	Farbe / Colour	VE / unit
16006	10,5	6,5	0,3		6
16007	10,5	6,5	0,3		6
16008	10,5	6,5	0,3		6



Cappuccinountertasse „SNUG“

cappuccino saucer
platillo de cappuccino
soucoupe cappuccino



Porzellan / porcelain / porcelana / porcelaine

	Ø cm	↑ cm		Farbe / Colour	VE / unit
16015	15,5	2,5			6
16016	15,5	2,5			6
16017	15,5	2,5			6

HOCHSTAPLER

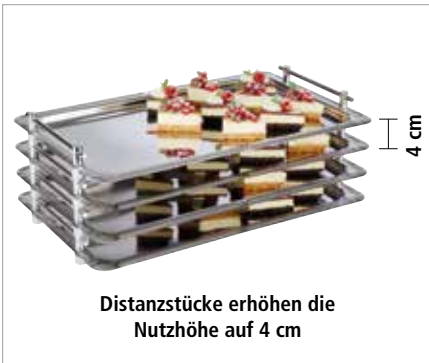

GN 1/1 System-Tablett „PROFI LINE“

GN 1/1 tray
GN 1/1 bandeja
GN 1/1 plateau



Dekorrand, hochglanzpoliert, Griffe verchromt, Distanzstücke erhöhen die Nutzhöhe auf 4 cm
decor edge, mirror polished, chrome plated handles, spacers increase the useful height to 4 cm
borde decorado pulido brillante, asas cromadas, los separadores aumentan la altura útil a 4 cm
bord avec reliefs poli brillant, poignées chromées, les entretoises portent la hauteur utile à 4 cm

	cm	↑ cm	GN
11300	53 x 32,5	5,5	1/1



GN 1/1 System-Tablett „BUFFET-STAR“

GN 1/1 tray
GN 1/1 bandeja
GN 1/1 plateau



Rand hochglanzpoliert, Distanzstücke erhöhen die Nutzhöhe auf 4 cm
mirror polished edge, spacers increase the useful height to 4 cm
borde pulido brillante, los separadores aumentan la altura útil a 4 cm
bord poli brillant, les entretoises portent la hauteur utile à 4 cm

	cm	↑ cm	GN	Griff / handle
11150	53 x 32,5	6,5	1/1	silver
11155	53 x 32,5	6,5	1/1	gold



GN 1/1 System-Tablett „CLASSIC“

GN tray
GN bandeja
GN plat empilable système catering



Rand hochglanzpoliert, Distanzstücke erhöhen die Nutzhöhe auf 4 cm
mirror polished edge, spacers increase the useful height to 4 cm
borde pulido brillante, los separadores aumentan la altura útil a 4 cm
bord poli brillant, les entretoises portent la hauteur utile à 4 cm

	cm	↑ cm	GN
11295	53 x 32,5	5,0	1/1



GN 1/1 Haube „HOCHSTAPLER“

GN 1/1 cover
GN 1/1 campana
GN 1/1 cloche



glasklarer Kunststoff, Haube fixiert sich auf dem Tablett, nahezu bruchfest
clear plastic, cover fixes itself on the tray, nearly unbreakable
plástico transparente, la tapa se fija a la bandeja para que no se deslice, resistente a la rotura
en plastique transparent, la cloche se fixe sur le dessous du plateau, résistant à la casse

	cm	↑ cm	fits to	GN
11305	53 x 32,5	9	11300, 11295	1/1



GN Behälter „PROFI LINE“

GN pan
GN cubeta
GN bac



	cm	↑ cm	GN	ltr.
11020	53,0 x 32,5	2,0	1/1	1,7
11040	53,0 x 32,5	4,0	1/1	3,4
11065	53,0 x 32,5	6,5	1/1	7,0
12065	32,5 x 26,5	6,5	1/2	3,3



GN Tablett „PROFI LINE“

GN tray
GN bandeja
GN plateau



mit glattem Rand / with smooth edge / borde liso / bord lisse

	cm	↑ cm	GN
11100	53,0 x 32,5	1,5	1/1
12100	32,5 x 26,5	1,5	1/2

mit Dekor-Rand / with decor-edge / con borde decorado / bords avec relief

	cm	↑ cm	GN
11000	53,0 x 32,5	1,5	1/1
12000	32,5 x 26,5	1,5	1/2

glatter schmaler Rand / smooth narrow edge / borde estrecho liso / bord étroit lisse

	cm	↑ cm	GN
11110	53,0 x 32,5	1,0	1/1



Tablett „PROFI LINE“

tray
bandeja
plateau



Dekorrand hochglanzpoliert
decor edge mirror polished
borde decorado pulido brillante
contour relief poli brillant

	Ø cm	↑ cm
11032	32	2,5



GN Abdeckhaube

GN cover
GN campana
GN cloche



	cm	↑ cm	✱ mm	GN
11041	32,5 x 26,5	9,5	3	1/2
11042	53,0 x 32,5	9,5	3	1/1
11043	32,5 x 17,6	10,5	3	1/3
11044	53,0 x 16,2	10,5	3	2/4

TRAYS STAINLESS STEEL



Tablett „SCHÖNER ESSEN“

tray
bandeja
plateau



mit Dekorrand, Griffe Zinkdruckguss verchromt, genietet

with decor edge, handles zinc alloy chrome plated, riveted

borde decorado, asas de fundición inyectada de cinc cromado, remachadas

bord décor, poignées en zamac chromé, rivetées

	cm	↑ cm
00082	52 x 31,0	3,0
00081	60 x 36,0	3,0
00084	75 x 44,5	3,0



Tablett „SCHÖNER ESSEN“

tray
bandeja
plateau



	cm	↑ cm	GN
00383	35,0 x 24,0	1,0	
00382	42,0 x 31,0	1,0	
00381	50,0 x 36,0	1,0	
00384	63,5 x 44,5	1,0	
00385	60,0 x 40,0	1,0	
00388	53,0 x 32,5	1,0	1/1

leichte Ausführung 0,5 mm / light model / modelo ligero / qualité légère

	cm	↑ cm
03824	42,0 x 31,0	1,0



Tablett mit Haube „SCHÖNER ESSEN“

tray with cover
bandeja con campana
plateau avec cloche



	cm	↑ cm
38202	42 x 31	8

Haube / cover / campana / cloche

	cm	↑ cm
08201	36,5 x 26,0	7,5



Tablett „FINESSE“

tray
bandeja
plateau

verchromte Messinggriffe / chrome plated brass handles / asas plateadas de latón / poignées en laiton chromées



	cm	↑ cm
01712	44 x 31	1,5



Tablett „FINESSE“

tray
bandeja
plateau



	cm	↑ cm
01322	42 x 30	2,5
01323	50 x 36	2,5
01324	60 x 41	2,5



Tablett „FINESSE“

tray
bandeja
plateau



	Ø cm	↑ cm
01332	32,0	1,0
01335	35,0	1,0
01338	38,0	1,0
01348	48,0	1,0



Tablett „FINESSE“

tray
bandeja
plateau



	cm	↑ cm
01314	30 x 24	1,0
01313	35 x 24	1,0
01317	39 x 26	1,0
01312	42 x 31	1,0
01318	48 x 30	1,0
01311	50 x 38	1,0
01310	58 x 42	1,0
01309	68 x 48	1,0

TRAYS STAINLESS STEEL



Schale

bowl
cuenco
bol

ingerollter Rand

rolled edge
borde enrollado
bord roulé



	cm	↑ cm	ltr.
40110	26,5 x 18,5	4,0	0,8



Servierpfanne

pan
fuente para la mesa
plat pour la table

mit vergoldeten Edelstahlgriffen, 1 mm dick

with gold-plated stainless steel handles, 1 mm thick
con asas doradas de acero inoxidable de 1 mm de grosor
avec poignées dorées en acier inox, 1 mm d'épaisseur



	cm	↑ cm	ltr.
61190	19	3,5	0,7
61280	28	4,0	2,0
61400	40	5,0	4,5
60270	26,5 x 19,5	3	0,8
60310	31,0 x 21,5	3	1,2



Edelstahltablett „FOCUS“

tray
bandeja
plateau



	cm	↑ cm
09010	43,5 x 32,5	1,5

Rolltophaube „FOCUS“ / rolltop cover / campana abatible / cloche basculante

	cm	↑ cm
09013	44 x 33,5	17



Tablett „ELEGANCE“

tray
bandeja
plateau



	cm	↑ cm
02311	48 x 30	1,0



Tablett „VINTAGE“

tray
bandeja
plateau

Antik-Edelstahl-Look
stainless steel antique look
acero estilo antiguo
acier style antique



	cm	↑ cm
30130	26,0 x 13,5	1,5
30131	34,0 x 18,0	1,5
30132	38,0 x 26,5	1,5
30133	25,5 x 16,0	3,0
30134	32,5 x 21,5	2,0

passende Schälchen / fitting bowls / cuencos adecuados / bols appropriés



	Ø cm	↑ cm	ltr.
40655	7,5	5,5	0,17
40656	7,5	10,0	0,35

Wachspapier / greaseproof paper squares / papel alimenticio / papier alimentaire

	cm	pcs.	Motiv:
40670	42 x 25	500	Zeitung

Seite 264
page 264



Servierbeispiel
presentation example



Tablett „TREND“

baking sheet
bandeja
plateau

ein Backblech wird zum Serviertablett
a baking sheet which becomes a serving tray
una bandeja de hornear que se convierte en una bandeja de servir
un moule qui devient un plateau de service



	cm	↑ cm
13380	32 x 21,5	2

TRAYS STAINLESS STEEL



Serviertablett „KAFFEEHAUS“

tray
bandeja
plateau

hochglanzpoliert, stabiler Rand eingerollt
mirror polished, stable edge rolled in
pulido brillante, borde estable enrollado
poli brillant, bord stable enroulé



	cm	↑ cm
30148	Ø 27	1,5
30149	30 x 15,5	1,5

passende Hauben / cover / campana / cloche



	cm	↑ cm	suitable for
11055	Ø 23	12,0	30148
11056	26 x 12	10,0	30149



Servierbeispiel
presentation example



Serviertablett „KAFFEEHAUS“

tray
bandeja
plateau

matt poliert, oval, Rand eingerollt
matt polished, oval, rolled edge
pulido mate, oval, borde enrollado
poli mat, ovale, bord enroulé



	cm	↑ cm	
30111	20,0 x 14,5	0,5	für Zucker und Sahne / for sugar and cream
30112	26,5 x 19,5	0,5	für eine Tasse / for one cup
30113	29,0 x 22,0	0,5	für zwei Tassen / for two cups

Antik-Edelstahl-Look
stainless steel antique look
acero estilo antiguo
acier style antique

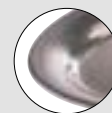

	cm	↑ cm	
30140	20,0 x 14,5	1,0	für Zucker und Sahne / for sugar and cream
30141	26,5 x 19,5	1,0	für eine Tasse / for one cup
30142	29,0 x 22,0	1,0	für zwei Tassen / for two cups



Serviertablett „KAFFEEHAUS“

tray
bandeja
plateau

hochglanzpoliert, oval, Rand eingerollt
mirror polished, oval, rolled edge
pulido brillante, ovalado, borde enrollado
poli brillant, ovale, bord enroulé



	cm	↑ cm	
30115	20,0 x 14,5	0,5	für Zucker und Sahne / for sugar and cream para azúcar y crema / pour le sucre et la crème
30116	26,5 x 19,5	0,5	für eine Tasse / for one cup para una taza / pour une tasse
30117	29,0 x 22,0	0,5	für zwei Tassen / for two cups para dos tazas / pour deux tasses



Serviertablett „KAFFEEHAUS“

tray
bandeja
plateau

matt poliert, Rand eingerollt

matt polished, rolled edge
pulido mate, borde enrollado
poli mat, bord enrollé



	cm	↑ cm
30118	21,5 x 13	1,5
30119	23,0 x 23	1,5



Serviertablett „KAFFEEHAUS“

tray
bandeja
plateau



	cm	↑ cm	Farbe / Colour
84251	26,0 x 20,0	1,5	■
84253	28,5 x 21,5	1,5	■



Serviertablett „KAFFEEHAUS“

tray
bandeja
plateau

Innenfläche ziseliert, Rand eingerollt

chiselled inner surface, rolled edge
superficie interior cincelada, borde enrollado
surface intérieure ciselée, bord enrollé



	cm	↑ cm	VE / unit
30114	30 x 22	1,0	48

TRAYS



Tablett mit Haube „FINESSE“

tray with cover
bandeja con campana
plateau avec cloche

2-teilig: Tablett aus Edelstahl + Haube

2 pcs.: stainless steel tray + cover
set de 2: bandeja de acero inoxidable + campana
set de 2: plateau en acier inox + cloche



	cm	↑ cm
13122	42 x 31	8,5



Tablett mit Haube „FINESSE“

tray with cover
bandeja con campana
plateau avec cloche

2-teilig: Tablett aus Edelstahl + Haube

2 pcs.: stainless steel tray + cover
set de 2: bandeja de acero inoxidable + campana
set de 2: plateau en acier inox + cloche



	Ø cm	↑ cm
13622	22	9,5



Tablett mit Haube „FINESSE“

tray with cover
bandeja con campana
plateau avec cloche

2-teilig: Tablett aus Edelstahl + Haube

2 pcs.: stainless steel tray + cover
set de 2: bandeja de acero inoxidable + campana
set de 2: plateau en acier inox + cloche



	Ø cm	↑ cm	Ø cm Hauben / cover
13382	38	12	30
13385	38	13	33



Tablett mit Haube

tray with cover
bandeja con campana
plateau avec cloche

2-teilig: Tablett aus Edelstahl, hochglanzpoliert + Haube

2 pcs.: stainless steel tray, mirror polished + cover
set de 2: bandeja de acero inoxidable, pulido brillante + campana
set de 2: plateau en acier inox, poli brillant + cloche



	Ø cm	↑ cm
00827	27	12,5



Tablett mit Haube

tray with cover
bandeja con campana
plateau avec cloche

2-teilig: Tablett aus Edelstahl, hochglanzpoliert + Haube

2 pcs.: stainless steel tray, mirror polished + cover
set de 2: bandeja de acero inoxidable, pulido brillante + campana
set de 2: plateau en acier inox, poli brillant + cloche



	cm	↑ cm
00828	30 x 15,5	10,5



Tablett mit Haube „ELEGANCE“

tray with cover
bandeja con campana
plateau avec cloche



2-teilig: Tablett aus Edelstahl + Haube

2 pcs.: stainless steel tray + cover
set de 2: bandeja de acero inoxidable + campana
set de 2: plateau en acier inox + cloche

	cm	↑ cm
00064	33 x 17	10
00067	25 x 19	7

Haube für 00064 / cover for 00064 / campana para 00064 / cloche pour 00064

06401

Haube für 00067 / cover for 00067 / campana para 00067 / cloche pour 00067

06701



Tortenplatte

cake plate
bandeja tartas
plat à gâteau



2-teilig: Tablett aus Edelstahl + Haube

2 pcs.: stainless steel tray + cover
set de 2: bandeja de acero inoxidable + campana
set de 2: plateau en acier inox + cloche

	Ø cm	↑ cm	
00065	30	11	mit 1 Haube / with 1 cover
00652	30	7 + 11	mit 2 Hauben / with 2 cover



Tortenplatte „BAROCK“

cake plate
bandeja tartas
plat à gâteau



2-teilig: Tortenplatte mit Barock-Rand + Haube

2 pcs.: cake plate with decor edge „Barock“ + cover
set de 2: porta tartas, borde decor „Barock“ + campana
set de 2: plateau bord décor „Barock“ + cloche

	Ø cm	↑ cm
06503	32	10

Frischhaltehaube / cover / campana / cloche

	Ø cm	↑ cm
06510	30	11,5

TRAYS



2 tlg.
2 pcs.

Tablett mit Haube

tray with cover
bandeja con campana
plateau avec cloche



2 teilig: Tablett aus geöltem Buchenholz (Ø 18,5 cm, H: 2,5 cm) + Glas-Haube (Ø 16 cm, H: 22,5 cm)

2 pcs.: tray of oiled beech wood + glass cover

set de 2: bandeja de madera haya + campana de cristal

set de 2 : plateau en bois de hêtre + cloche en verre

Ø cm ↑ cm

00830 18,5 24



2 tlg.
2 pcs.

Tablett mit Haube, 2-teilig

tray with cover, 2 pcs.
bandeja con campana, set de 2
plateau avec cloche, set de 2



Tablett aus Bambus, ölimprägniert + Haube

bamboo tray, oil-impregnated + cover

bandeja de bambú, impregnada de aceite + campana

plateau en bambou, imprégné d'huile + cloche

Ø cm ↑ cm

00825 25 13,5



2 tlg.
2 pcs.

Tablett mit Haube, 2-teilig

tray with cover, 2 pcs.
bandeja con campana, set de 2
plateau avec cloche, set de 2



Tablett aus Bambus, ölimprägniert + Haube

bamboo tray, oil-impregnated + cover

bandeja de bambú, impregnada de aceite + campana

plateau en bambou, imprégné d'huile + cloche

cm ↑ cm

00826 28 x 14 11,5



2 tlg.
2 pcs.

Tablett mit Haube, 2 teilig

tray with cover, 2 pcs.
bandeja con campana, set de 2
plateau avec cloche, set de 2



Tablett aus Bambus, ölimprägniert + Haube

bamboo tray, oil-impregnated + cover

bandeja de bambú, impregnada de aceite + campana

plateau en bambou, imprégné d'huile + cloche

Ø cm ↑ cm

00822 20,5 10



2 tlg.
2 pcs.

00820

00821

Kastenkuchengröße
box-cake size

Tablett mit Haube, 2 teilig

tray with cover, 2 pcs.
bandeja con campana, set de 2
plateau avec cloche, set de 2



Tablett aus Bambus, ölimprägniert + Haube

bamboo tray, oil-impregnated + cover

bandeja de bambú, impregnada de aceite + campana

plateau en bambou, imprégné d'huile + cloche

cm ↑ cm

00820 24 x 18,5 8

00821 32 x 16,5 11



Rolltop-Set

rolltop set
set rolltop
set cloche à fromage



2-teilig: Tablett + Rolltophaube glasklar, rutschfeste Haubenfixierung, klappbar

2 pcs.: tray + rolltop cover, cover non-slip fixed, mountable
set de 2: bandeja + campana abatible fijación antideslizante, montable
set de 2: plateau + cloche abattante, fixation antidérapants, montable

	Ø cm	↑ cm
09080	38	24
09099	50	28



Rolltop-Set, 3-teilig

rolltop set, 3 pcs.
rolltop, set de 3
rolltop, set de 3



1 Edelstahltablett Ø 38 cm + 1 Naturschieferplatte Ø 33 cm + 1 Rolltophaube Ø 38 cm

1 stainless tray Ø 38 cm + 1 natural slate tray Ø 33 cm + 1 rolltop cover Ø 38 cm
1 bandeja de acero inoxidable Ø 38 cm + 1 bandeja de pizarra natural Ø 33 cm + 1 tapa abatible Ø 38 cm
1 plat inox Ø 38 cm + 1 plat ardoise naturelle Ø 33 cm + 1 cloche Ø 38 cm

	Ø cm	↑ cm
01000	38	24



Kaviarkühler

caviar cooler
enfriador de caviar
rafraîchisseur de caviar



4-teilig: 1 Edelstahlschale, 1 Halter, 1 Glasschale, 1 Edelstahldeckel

4 pcs.: 1 stainless steel bowl, 1 holder, 1 glass bowl Ø 10 cm, 1 stainless steel cover
set de 4: 1 bol de acero inoxidable, 1 soporte, 1 bol de vidrio Ø 10 cm, 1 tapa de acero inoxidable
set de 4: 1 bol en acier inox, 1 support, 1 bol en verre Ø 10 cm, 1 couvercle en acier inox

	Ø cm	↑ cm
01699	18	12



Serviertöpfchen „MUMBAI“

small serving pot
olla pequeña de servir
marmite petite de servir



gehämmerte Oberfläche

hammered surface
superficie martillada
surface martelée

	Ø cm	↑ cm	ltr.	Griff / handle cm
40186	9,5	5,5	0,30	2,5
40187	13,5	5,0	0,55	3,0
40188	15,5	5,0	0,75	3,0

TRAYS



Partyplatte „CLASSIC“

partytray
bandeja party
plateau party

Rand eingerollt

rolled edge
borde enrollado
bord enroulé



	cm	↑ cm	GN		VE / unit
00396	Ø 35	1,5	-	round	48
00398	46,0 x 34,0	1,5	-	oval	48
00399	41,0 x 31,0	1,5	-		48
00389	35,4 x 32,5	1,5	2/3		48
00395	53,0 x 32,5	1,5	1/1		36



Partyplatte „CLASSIC“

partytray
bandeja party
plateau party

Rand eingerollt

rolled edge
borde enrollado
bord enroulé



	cm	↑ cm		VE / unit
00393	Ø 35	1,5	round	48
00391	46 x 34	1,5	oval	48

	cm	↑ cm	GN	VE / unit
00392	41 x 31	1,5	-	48
00394	53 x 32,5	1,5	1/1	48





Serviertablett „HAPPY HOUR“

tray
bandeja
plateau



rutschfeste Oberfläche / non-slip surface / superficie antideslizante / surface antidérapante

	Ø cm	↑ cm	Farbe / Colour
00510	32	1,5	■
00511	38	1,5	■
00515	43	1,5	■



Bierglasträger „NON SLIP“

beer rack
bandeja para cerveza
porte verre à bière



rutschfeste Oberfläche / non-slip surface / superficie antideslizante / surface antidérapante

	Ø cm	↑ cm	Farbe / Colour
00500	36	3,5	■
00506	28 x 20	1,5	■



Tablett „GASTRO“

tray
bandeja
plateau



rutschfeste Oberfläche / non-slip surface / superficie antideslizante / surface antidérapante

	Ø cm	↑ cm	Farbe / Colour
00547	27,5	2	■
00548	35,5	2	■
00549	40,5	2	■



Tablett „BISTRO“

tray
bandeja
plateau



rutschfest, mit 2 Griffmulden und Stapelrand

non-slip, two open handles, stackable edge
antideslizante, con 2 asas y borde apilable
antidérapant, avec 2 poignées et bord d'empilage

	Ø cm	↑ cm	Farbe / Colour
84045	35,5	4,5	■



Serviertablett „NON SLIP“

tray non-slip
bandeja
plateau



rutschfeste Oberfläche / non-slip surface / superficie antideslizante / surface antidérapante

	cm	↑ cm	GN	Farbe / Colour
00502	53,0 x 32,5	1,5	1/1	■
00508	46,0 x 36,0	2,0		■



FAST FOOD TRAYS



Fast Food-Tablett
 snack tray
 bandeja autoservicio y snacks
 plateau self-service et snacks



	cm	↑ cm	GN	Farbe / Colour
00530	35 x 27,0	2		
00535	41 x 30,5	2		
00540	45 x 35,5	2		
00552	53 x 32,5	2	1/1	

	cm	↑ cm	GN	Farbe / Colour
00531	35 x 27,0	2		
00536	41 x 30,5	2		
00541	45 x 35,5	2		
00553	53 x 32,5	2	1/1	

	cm	↑ cm	GN	Farbe / Colour
00532	35 x 27,0	2		
00537	41 x 30,5	2		
00542	45 x 35,5	2		
00554	53 x 32,5	2	1/1	

	cm	↑ cm	GN	Farbe / Colour
00533	35 x 27,0	2		
00538	41 x 30,5	2		
00543	45 x 35,5	2		
00555	53 x 32,5	2	1/1	

	cm	↑ cm	GN	Farbe / Colour
00534	35 x 27,0	2		

	cm	↑ cm	GN	Farbe / Colour
00539	35 x 27,0	2		



stapelbar
 stackable

CAKE STANDS



Servier- und Tortenplatte „CASUAL“

cake plate
porta pasteles
présentoir à gâteaux



	Ø cm	↑ cm
83890	31	8
83891	31	16
	cm	↑ cm
83892	31 x 31	8
83893	31 x 31	16



Servier- und Tortenplatte

cake stand
porta pasteles
présentoir à gâteaux



Rand fixiert die Haube, mit Antirutschfüßchen
carved edge fixes the cover, with non-slip feet
ranura para fijar bien la campana, con pies antideslizantes
bord rainuré pour maintenir ferme la cloche, avec pieds antidérapants

	Ø cm	↑ cm	Farbe / Colour	fits to cover
00468	31	3,5	White	06520
00469	31	3,5	Black	06520



CAKE STANDS

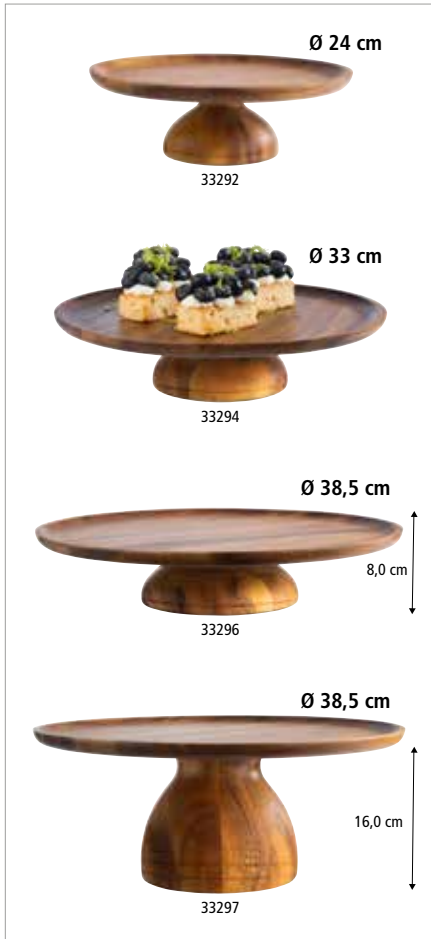

Servier- und Tortenplatte „ACACIA“

cake stand
porta pasteles
présentoir à gâteaux

Akazienholz geölt, möbelschonende Unterseite
acacia wood oiled, furniture-friendly underside
madera de acacia aceitada, con base anti rayaduras
bois d'acacia huilé, avec revêtement antirayures



	Ø cm	↑ cm
33292	24,0	8
33293	24,0	16
33294	33,0	8
33295	33,0	16
33296	38,5	8
33297	38,5	16

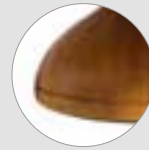

mit Rille
with groove

Frischhaltehaube / cover / campana / cloche



	Ø cm	↑ cm	fits to
06519	21	17	33292, 33293
06520	30	22	33294, 33295
06521	36	27	33296, 33297



Servier- und Tortenplatte

cake stand
porta pasteles
présentoir à gâteaux

matt poliert, drehbar, möbelschonende Unterseite
matt polished, rotating, furniture-friendly underside
pulido mate, giratoria, con base anti rayaduras
poli mat, pivotant, avec revêtement antirayures



	Ø cm	↑ cm
00463	30,5	9



Servier- und Tortenplatte

cake stand
porta pasteles
présentoir à gâteaux

matt poliert / matt polished / pulido mate / poli mat



	Ø cm	↑ cm
00046	31	3



Auslagen- / Kuchenplatte

display / cake plate
expositor / plato para tartas
présentoir / assiette à gâteau

ideale Größe für Baumkuchen / Stollen
ideal size for Baumkuchen / Stollen
tamaño ideal para Baumkuchen / Stollen
taille idéale pour Baumkuchen / Stollen



	cm	↑ cm
00047	40 x 16	2,5

SUPER DOME



Frischhaltehaube „SUPER DOME“

cover
campana
cloche



schwere, glasklare Qualität
stable, crystal clear quality
muy resistente y transparencia cristalina
haute résistance et transparence

	Ø cm	↑ cm
06525	30	40

passende Servier-/Tortenplatten / suitable cake stands / porta pasteles compatibles /
présentoirs à gâteaux compatibles

	Ø cm	↑ cm	fits to	Farbe / Colour
00468	31,0	3,5	06525	
33294	33,0	8,0	06525	
33295	33,0	16,0	06525	

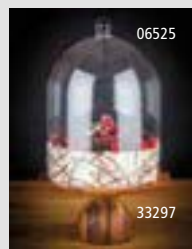

Präsentationsmöglichkeiten
presentation examples



Frischhaltehaube

cover
campana
cloche



schwere, glasklare Qualität
stable, crystal clear quality
calidad estable y transparencia cristalina
qualité stable et clarté cristalline

	Ø cm	↑ cm	fits to
06519	21	17	
06520	30	22	84177, 83891, 83890, 83884, 998, 975, 469, 468, 463, 46
06521	36	27	

NATURAL SLATE



EXTRA STRONG
6-9 mm thickness

Naturschiefer speichert auf natürliche Weise Kälte besonders gut. Die Kanten der Platten sind gebrochen und nicht gesägt.

Natural slate stores cold particularly well in a natural way. The edges of the panels are broken and not sawn.

La pizarra natural almacena el frío especialmente bien de forma natural. Los bordes de las bandejas están rotos y no aserrados.

L'ardoise naturelle stocke particulièrement bien le froid de manière naturelle. Les bords des plateaux sont brisés et non sciés.



Kühlbox „SLATE“ refrigerated buffet display expositor buffet frío plateau buffet froid

3-teilig, bestehend aus: 1 Basis aus schwarzem Polystyrol,
1 Naturschieferplatte, 1 Kühlakku (ohne Haube)

3 pcs., set consists of: 1 base made of black polystyrene, 1 natural slate tray,
1 cooler (without cover)

set de 3 compuesto por: 1 soporte de poliestireno negro, 1 bandeja de pizarra natural,
1 acumulador de frío (sin campana)

set de 3 composé de: 1 support en polystyrène noir, 1 plateau en ardoise naturelle,
1 accumulateur de froid (sans couvercle)



	cm	↑ cm
11645	58 x 38	6,5

Naturschieferplatte / natural slate tray / bandeja de pizarra natural / plateau ardoise naturelle

	cm	* mm
00979	58 x 38	6 - 9

Kühlakku / cooler / acumulador de frío / accumulateur de froid

	cm	↑ cm
10782	41 x 21	2,5

Basis / base / soporte / support

	cm	↑ cm
11619	52 x 32	5,5

GN Rolltophaube mit schwarzem Griff / GN rolltop cover with black handle / GN campana rolltop con mango negro / GN cloche rolltop avec poignée noire

	cm	↑ cm	GN
11075	53 x 32,5	19	1/1



GN 1/1 Naturschieferplatte „HOCHSTAPLER“

GN 1/1 natural slate tray
GN 1/1 bandeja de pizarra natural
GN 1/1 plat ardoise naturelle



	cm	↑ cm	* mm
00966	53 x 32,5	6	6 - 9

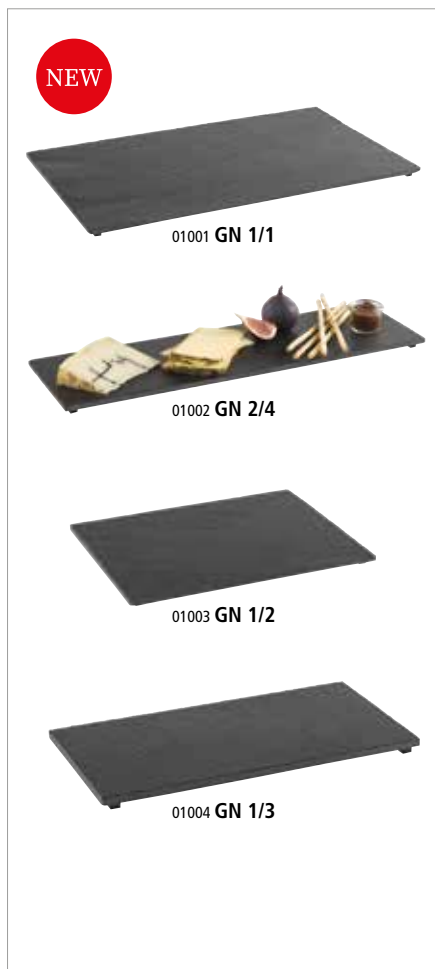

Griffe verchromt, 4 cm Nutzhöhe
chrome plate handles, 4 cm distance

**GN Naturschieferplatte**

GN natural slate tray
GN bandeja pizarra natural
GN plat ardoise naturelle



möbelschonende Unterseite, gerade Kanten

non-scratching undersurface, straight edges

base anti rayaduras, bordes rectos

avec revêtement antirayures, bords rectilignes

	cm	* mm	GN
01001	53 x 32,5	6 - 9	1/1
01002	53 x 16,2	6 - 9	2/4
01003	32,5 x 26,5	6 - 9	1/2
01004	32,5 x 17,6	6 - 9	1/3

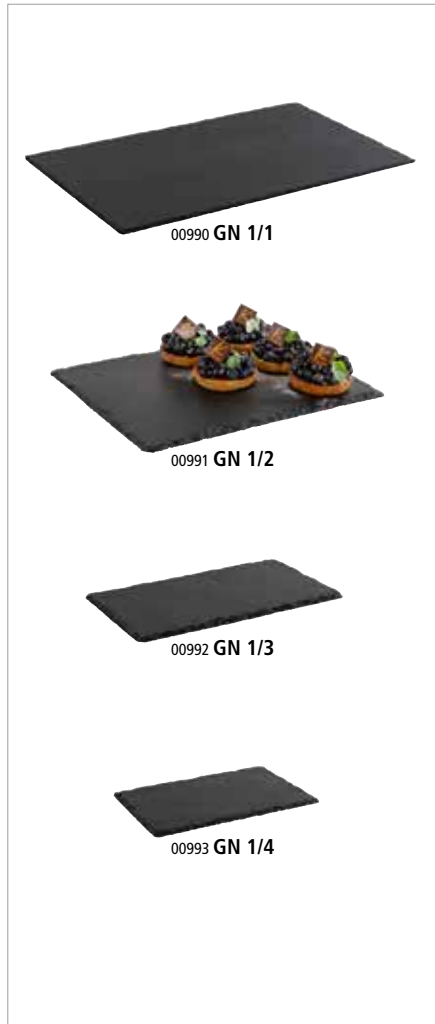

gerade Kanten
straight edges

**GN Naturschieferplatten**

GN natural slate tray
GN bandeja de pizarra natural
GN plat ardoise naturelle



	cm	* mm	GN
00990	53,0 x 32,5	6 - 9	1/1
00991	32,5 x 26,5	6 - 9	1/2
00992	32,5 x 17,6	6 - 9	1/3
00993	26,5 x 16,2	6 - 9	1/4
00973	53,0 x 16,2	6 - 9	2/4

SERVING BOARDS | NATURAL SLATE



Naturschieferplatte
 natural slate tray
 bandeja de pizarra natural
 plat ardoise naturelle



	cm	✦ mm	
00996	45 x 30	6 - 9	
00979	58 x 38	6 - 9	mit Safrille / with juice groove

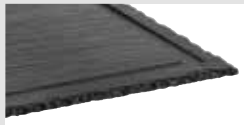

00979 mit Safrille
 00979 with juice groove



Naturschieferplatte
 natural slate tray
 bandeja de pizarra natural
 plat ardoise naturelle



	cm	✦ mm	
00994	25 x 25	6 - 9	
00995	30 x 30	6 - 9	



Naturschieferplatte
 natural slate
 bandeja de pizarra natural
 plateau ardoise naturelle



	cm	✦ mm	
00941	24,0 x 15,0	6 - 9	
00942	26,5 x 20,5	6 - 9	
00943	47,0 x 10,0	6 - 9	
00988	30,0 x 12,0	6 - 9	

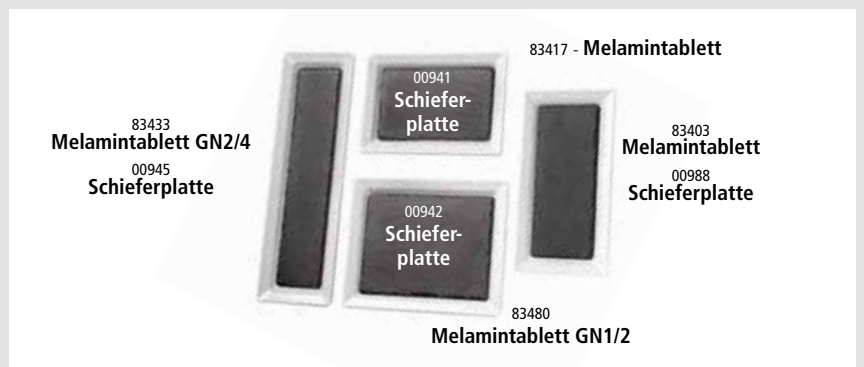

**Naturschieferplatte**

natural slate tray
bandeja pizarra natural
plat ardoise naturelle

mit Safrille, Ø 9,5 cm Aussparung

with juice groove, with hole Ø 9,5 cm

con ranura para líquidos, con agujero Ø 9,5 cm

avec rigole, avec trou Ø 9,5 cm



cm * mm

00947 33 x 24 6 - 9

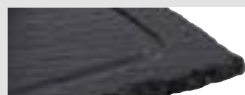

mit Safrille

with juice groove

Wachspapier / greaseproof paper squares / papel alimenticio / papier alimentaire

cm pcs.

40670 42 x 25 500 Motiv: Zeitung

Servier-Frittierkorb / fry baskets / cestitas para el servicio mesa / paniers pour le service sur table

Ø cm ↑ cm Griff / handle cm Farbe / Colour

40601	9	8,5	9,0		stainless steel
40603	9	8,5	9,0		copper
40625	9	8,5	9,0		black matt

**Naturschieferplatte**

natural slate tray
bandeja pizarra natural
plat ardoise naturelle

mit 3 x Aussparungen, Ø 6 cm

with 3 holes, Ø 6 cm

con 3 agujeros, Ø 6 cm

avec 3 trous, Ø 6 cm



cm * mm

00987 28 x 10 6 - 9

**Naturschieferplatte**

natural slate tray
bandeja pizarra natural
plat ardoise naturelle

mit Aussparung, Ø 6 cm

with hole Ø 6 cm

con agujero Ø 6 cm

avec trou Ø 6,0 cm



cm * mm

00986 25 x 12 6 - 9

**Naturschieferplatte / Untersetzer**

natural slate tray
bandeja de pizarra natural
plateau ardoise naturelle

mit 2 Aussparungen, Ø 6 cm

with 2 holes Ø 6 cm

con 2 agujeros Ø 6 cm

avec 2 trous Ø 6 cm



cm * mm

00971 15 x 8 6 - 9

SERVING BOARDS | NATURAL SLATE



Naturschieferplatte „STARTER“
 natural slate tray
 bandeja de pizarra natural
 plat ardoise naturelle



	cm	* mm
00937	20 x 10	6 - 9



00969

Naturschieferplatte
 natural slate tray
 bandeja de pizarra natural
 plat ardoise naturelle



	Ø cm	* mm
00968	22	6 - 9
00969	28	6 - 9
00998	33	6 - 9
00999	38	6 - 9



Präsentationsmöglichkeit
 presentation example



Tortenplatte / Servierplatte
 cake stand
 soporte para pastel
 présentoir à gâteaux



drehbar
 rotatable
 giratorio
 rotatif

	Ø cm	↑ cm	* mm
00975	32	2,5	6 - 9



drehbare Servierplatte
 rotatable cake stand



3 tlg.
 3 pcs.

Rolltop-Set
 rolltop set
 rolltop set
 rolltop set



- 3-teilig: • 1 Edelstahltablett Ø 38 cm
 • 1 Naturschieferplatte Ø 33 cm
 • 1 Rolltophaube Ø 38 cm
- 3 pcs.: • 1 stainless steel tray Ø 38 cm
 • 1 natural slate tray Ø 33 cm
 • 1 rolltop cover Ø 38 cm
- set de 3: • 1 bandeja de acero inoxidable Ø 38 cm
 • 1 bandeja de pizarra natural Ø 33 cm
 • 1 campana abatible Ø 38 cm
- set de 3: • 1 plateau en acier inox 38 cm
 • 1 plateau ardoise naturelle 33 cm
 • 1 cloche basculante 38 cm

	Ø cm	↑ cm
01000	38	24

**3-stufige Etagère**

3-tier tray
bandeja con tres alturas
étagère carré 3 hauteurs

Naturschiefer, Akazienholz
natural slate tray, wood akazie
bandeja de pizarra natural, madera de acacia
plateau ardoise naturelle, bois d'acacia



	Ø cm	↑ cm	* mm
00960	30 / 25 / 20	34	6 - 9

**2-stufige Etagère**

2-tier tray
bandeja dos alturas
étagère carré 2 hauteurs

Naturschiefer
natural slate tray
bandeja de pizarra natural
plateau ardoise naturelle



	Ø cm	↑ cm	* mm
00989	25 / 20	24	6 - 9

**Naturschieferplatte**

natural slate tray
bandeja de pizarra natural
plateau ardoise naturelle

2-teilig: Naturschieferplatte mit Glashaube

2 pcs.: natural slate tray with glass cover
set de 2: bandeja de pizarra natural con tapa de cristal
set de 2: plateau ardoise naturelle avec cloche en verre

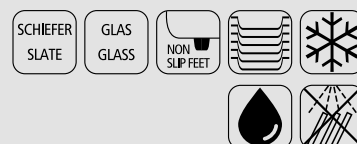

	Ø cm	↑ cm	* mm
00984	10,5	8	6 - 9

**Naturschieferplatten, 4er Set**

natural slate tray, 4 pcs.
bandeja pizarra natural, set de 4
plateau ardoise naturelle, set de 4



	cm	* mm	pcs.
00997	10 x 10	6 - 9	4





SIMPLY WOOD

Eiche, das widerstandsfähigste europäische Holz, ist seit jeher Ausdruck von Qualität, Kraft und Energie.
Eichen werden uralt und riesengroß, sind unvergleichlich stark und standfest.

Oak, the most resistant European wood, has always been an expression of quality, strength and energy.
Oaks grow to be ancient and huge, are incomparably strong and stable.

El roble, la madera europea más resistente, siempre ha sido expresión de calidad, fuerza y energía.
Los robles llegan a ser antiguos y gigantes, son incomparablemente fuertes y estables.

Le chêne, le bois européen le plus résistant, est depuis toujours l'expression de la qualité, de la force et de l'énergie.
Les chênes deviennent très vieux et gigantesques, ils sont incomparablement forts et stables.



Servierbrett „SIMPLY WOOD“

servicing board
tabla de servir
planche de service



Eichenholz geölt, mit Aufhängeloch Ø 1,5 cm, mit Lederband

oak wood oiled, with handle hole Ø 1,5 cm, with leather strap
madera de roble aceitada, con agujero para colgar Ø 1,5 cm, con correa de cuero
bois de chêne huilé, avec trou de suspension Ø 1,5 cm, avec ruban en cuir

	cm	↑ cm	→ Griff / handle
00750	20 x 20	2	8
00751	27 x 17	2	8
00752	32 x 22	2	8



mit Lederband
with leather strap



Tablett / Sushiboard „SIMPLY WOOD“

tray / sushiboard
bandeja para sushi
plateau sushi

aus geöltem Eichenholz
made of oiled oak wood
de madera de roble aceitada
en bois de chêne huilé

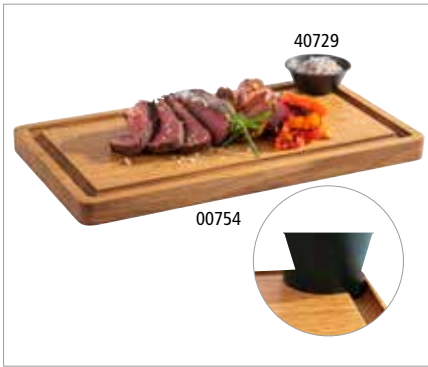

	cm	↑ cm
00753	35 x 17	2

**GN 1/3 Servierbrett „SIMPLY WOOD“**

GN 1/3 serving board
GN 1/3 tabla de servir
GN 1/3 planche de service



Eichenholz geölt, mit Aussparung Ø 4 cm, mit Safrinne

oak wood oiled, with notch Ø 4 cm, with juice groove
madera de roble aceitada, con ranura Ø 4 cm, con ranura para líquidos
bois de chêne huilé, mit avec encoche Ø 4 cm, avec rigole

	cm	↑ cm	GN
00754	32,5 x 17,6	2	1/3

**Servierbrett**

serving board
tabla de servir
planche de service



Eichenholz, geölt, 2 Aussparungen Ø 4,5 cm, 1 Aussparung Ø 3 cm, mit 2 Griffmulden

oak wood oiled, 2 notches Ø 4,5 cm, 1 notch Ø 3 cm, with 2 recessed handles
madera de roble aceitada, 2 ranuras Ø 4,5 cm, 1 ranura Ø 3 cm, con 2 asas empotradas
bois de chêne huilé, 2 encoches Ø 4,5 cm, 1 encoche Ø 3 cm, avec 2 poignées encastrées

	cm	↑ cm
00835	15 x 9	1,5

passende Gläser / fitting glasses / tarros de vidrio adecuados / verrines appropriées

	Ø cm	↑ cm	ltr.	pcs
82350	5,5	6	0,075	12

**Servierbrett „PIZZA“**

serving board
tabla de servir
planche de service



Eichenholz geölt, mit Safrinne, mit 2 Griffmulden

oak wood oiled, with juice groove, with 2 recessed handles
madera de roble aceitada, con ranura para líquidos, con 2 asas empotradas
bois de chêne huilé, avec rigole, avec 2 poignées encastrées

	Ø cm	↑ cm
00755	24	2
00756	29	2
00757	34	2

**Serviertablett**

serving tray
bandeja para servir
plateau de service



aus geöltem Eichenholz, mit 2 Griffmulden

made of oiled oak wood, with 2 recessed handles
de madera de roble aceitada, con 2 asas empotradas
en bois de chêne huilé, avec 2 poignées encastrées

	cm	↑ cm
00761	45 x 35	6



SERVING BOARDS



Servierbrett
 serving board
 tabla de servir
 planche de service
 aus geöltem Akazienholz
 made of oiled acacia wood
 de madera de acacia aceitada
 en bois d'acacia huilé



	cm	↑ cm
00793	25 x 17	1,5



Servierbrett
 serving board
 tabla de servir
 planche de service
 aus geöltem Akazienholz
 made of oiled acacia wood
 de madera de acacia aceitada
 en bois d'acacia huilé



	cm	↑ cm
00792	37 x 8	2



Präsentationsmöglichkeit
 presentation example



Servierschale
 serving bowl
 cuenca de servir
 bol de service
 aus geöltem Akazienholz
 made of oiled acacia wood
 de madera de acacia aceitada
 en bois d'acacia huilé



	cm	↑ cm
00790	16,5 x 9	2
00791	23,5 x 13	2



Servierbrett

serving board
tabla de servir
planche de service



2-teilig: 1 Holzbrett aus Akazienholz + 1 Naturschieferplatte
2 pcs.: 1 wood board made of acacia wood + 1 natural slate tray
set de 2: 1 tabla de madera de acacia + 1 pizarra natural
set de 2: 1 planche en bois d'acacia + 1 ardoise naturelle

	cm	↑ cm
00814	28 x 17,5	2



Servierbrett

serving board
tabla de servir
planche de service



2-teilig: 1 Holzbrett aus Akazienholz + 1 Naturschieferplatte
2 pcs.: 1 wood board made of acacia wood + 1 natural slate tray
set de 2: 1 tabla de madera de acacia + 1 pizarra natural
set de 2: 1 planche en bois d'acacia + 1 ardoise naturelle

	cm	↑ cm	Griff / handle cm
00810	26 x 18	2	8
00811	33 x 20	2	8
00812	40 x 15	2	5
00813	43 x 12	2	12

Präsentationsmöglichkeit

presentation example



mit Hängeloch Ø 2 cm / with a handle-hole Ø 2 cm

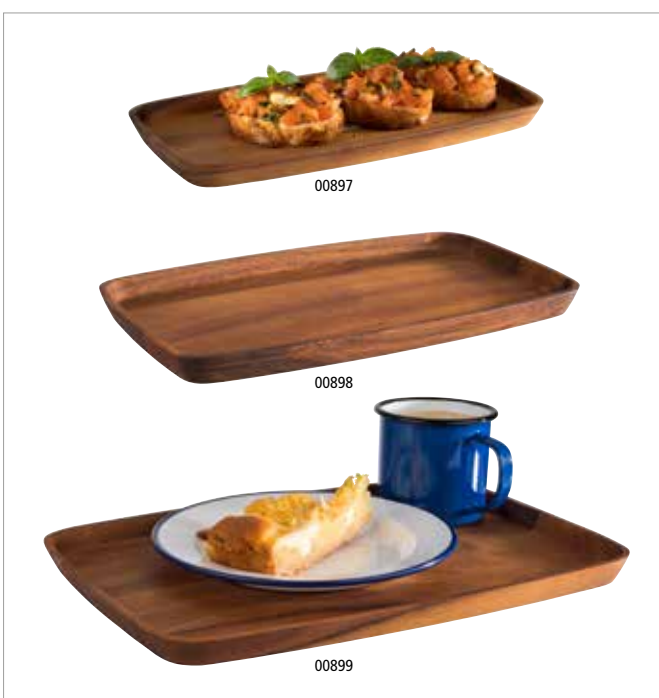

Servierbrett

serving board
tabla de servir
planche de service



Servierbrett aus geöltem Akazienholz
serving board made of oiled acacia wood
tabla de servir de madera de acacia aceitada
planche en bois avec plateau en bois d'acacia huilé

	cm	↑ cm
00897	30 x 15	2
00898	30 x 18	2
00899	35 x 25	2

SERVING BOARDS | WOOD



Servierbrett „SHARING“

serving board
tabla de servir
planche de service



Servierbrett aus geöltem Akazienholz

serving board made of oiled acacia wood
tabla de servir de madera de acacia aceitada
planche en bois d'acacia huilé

	cm	↑ cm	Griff / handle cm
00887	51,5 x 18	1,5	8,5



Servierbrett „AKAZIE-SCHIEFER“

serving board
tabla de servir
planche de service

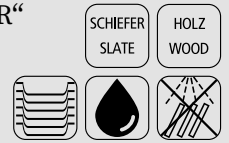

geeignet zur Beschriftung, mit Hängeloch Ø 1 cm

suitable for labeling, with hanging hole Ø 1 cm
apto para rotulación, con orificio para colgar Ø 1 cm
adapté pour l'étiquetage, avec trou de suspension Ø 1 cm

	cm	↑ cm	Griff / handle cm
00867	30,5 x 13	1,5	10
00868	36,5 x 15	1,5	12
00869	42,0 x 18	1,5	14



Servierbrett „OAK“

serving board
tabla de servir
planche de service



aus geöltem Eichenholz, Safrille, Ø 9,5 cm Aussparung

made of oiled oak, with juice groove, with hole Ø 9.5 cm
de madera de roble aceitada, con ranura para líquidos,
con agujero Ø 9,5 cm

en bois chêne huilé, avec rigole, avec trou Ø 9,5 cm

	cm	↑ cm
00808	37 x 25	2



mit Safrille
with juice groove



00905



00906

Servierbrett „OLIVE“

serving board
tabla de servir
planche de service



aus geöltem Olivenholz, naturbedingte Abweichung in Form, Maserung und Größe

oiled olive wood, natural deviation in shape, grain and size
de madera de olivo aceitada, diferencias naturales posibles en forma, grano y tamaño

en bois d'olivier huilé, éventuelles différences naturelles de forme, de grain et de taille

	cm	↑ cm
00905	25,5 x 16,5	1,5
00906	35,0 x 20,5	1,5



00870



00873



00875

Servierbrett „OLIVE“

serving board
tabla de servir en madera de olivo
planche de service en bois d'olivier



aus geöltem Olivenholz, naturbedingte Abweichung in Form, Maserung und Größe, mit Hängeloch Ø 2 cm

oiled olive wood, natural deviation in shape, grain and size, with hanging hole Ø 2 cm

de madera de olivo aceitada, diferencias naturales posibles en forma, grano y tamaño, con orificio para colgar Ø 2 cm

en bois d'olivier huilé, éventuelles différences naturelles de forme, de grain et de taille, avec trou de suspension Ø 2 cm

	cm	↑ cm	Griff / handle cm
00870	25 x 17,0	1,5	
00871	30 x 20,5	2,0	
00873	40 x 15,0	1,5	11
00874	44 x 20,0	2,0	12
00875	19 x 12,5	1,5	6
00876	25 x 16,0	1,5	8
00877	31 x 20,0	1,5	9

SERVING BOARD



Ø 6 cm

82316



beidseitig nutzbar
double-sided usable

Servierbrett

servicing board
tabla de servir
planche de service

aus geöltem Eichenholz, mit 8 Aussparungen Ø 6 cm
made of oiled oak wood, with 8 notches Ø 6 cm
de madera de roble aceitada con 8 ranuras Ø 6 cm
en bois de chêne huilé avec 8 encoches Ø 6 cm



	cm	↑ cm
00809	100 x 14	1,5

Präsentationsmöglichkeit presentation example



40636
Henkelbecher
beaker

mit Hängeloch Ø 2 cm / with a handle-hole Ø 2 cm



mit Hängeloch Ø 1,5 cm
with a handle-hole Ø 1,5 cm



Präsentationsmöglichkeit
presentation example

Servierbrett

servicing board
tabla de servir
planche de service

aus geöltem Buchenholz mit Daumenmulde auf einer Seite
made of oiled beech wood with thumb recess on one side
de madera de haya aceitada con hueco para el pulgar en un lado
en bois de hêtre huilé avec encoche pour le pouce sur un côté



	cm	↑ cm
00817	60 x 19,5	2

**Servierbrett „GENUSSPALETTE“**

serving board
tabla de servir
planche de service

Genusspalette im Kleinformat, Birke

mini serving palett, birch
tabla de servir, formato pequeño, abedul
planche de service, petit format, bouleau



	cm	↑ cm
00880	20 x 12	3
00881	30 x 20	3
00882	40 x 15	3

**Table Caddy „OLIVE“**

table barrel
caddy de mesa
caddy de table

aus geöltem Olivenholz

oiled olive wood
de madera de olivo aceitada
en bois d'olivier huilé



	cm	↑ cm
01016	22 x 15	6
01017	25 x 18	6

**Allzweckstreuer, 12 er Set / shaker, 12 pcs. / dosificador, set de 12 / salières/poivrières set de 12**

	cm	↑ cm	litr.
40504	4 x 4	10	0,07

passende Brottasche / suitable bread basket / panera a juego / corbeilla assortie

	cm	↑ cm	Farbe / Colour
30356	12 x 11,5	11,5	■

passende Mühlen / suitable mills/ molinos de ajuste / moulins assortis

	ø cm	↑ cm
40555	6	15,5
40556	6	15,5

**Wachspapier „SNACKHOLDER“**

greaseproof paper squares
papel alimenticio
papier alimentaire



	cm	pcs.	Motiv:
40670	42 x 25	500	Zeitung



01010 **0,15 ltr.**

01011 **0,25 ltr.**

01012 **0,50 ltr.**

Schale „OLIVE“
bowl
cuenco
bol

aus geöltem Olivenholz, naturbedingte Abweichung in Form, Maserung und Größe
oiled olive wood, natural deviation in shape, grain and size
de madera de olivo aceitada, diferencias naturales posibles en forma, grano y tamaño
en bois d'olivier huilé, éventuelles différences naturelles de forme, de grain et de taille

HOLZ WOOD 

	Ø cm	↑ cm	ltr.
01010	10,0	4,0	0,15
01011	12,5	4,5	0,25
01012	15,0	6,0	0,50



3 Größen ineinander
3 sizes in each other



00843 **0,05 ltr.**

00844 **0,10 ltr.**

Schale „OLIVE“
bowl
cuenco
bol

aus geöltem Olivenholz, naturbedingte Abweichung in Form, Maserung und Größe
oiled olive wood, natural deviation in shape, grain and size
de madera de olivo aceitada, diferencias naturales posibles en forma, grano y tamaño
en bois d'olivier huilé, éventuelles différences naturelles de forme, de grain et de taille

HOLZ WOOD 

	cm	↑ cm	ltr.
00843	12,0 x 7,5	2,5	0,05
00844	16,5 x 9,5	2,5	0,10



00907 **0,20 ltr.**

00908 **0,30 ltr.**

01023 **0,40 ltr.**

Schale „OLIVE“
bowl
cuenco
bol

aus geöltem Olivenholz, naturbedingte Abweichung in Form, Maserung und Größe
oiled olive wood, natural deviation in shape, grain and size
de madera de olivo aceitada, diferencias naturales posibles en forma, grano y tamaño
en bois d'olivier huilé, éventuelles différences naturelles de forme, de grain et de taille

HOLZ WOOD 

	cm	↑ cm	ltr.
00907	13 x 8	6,5	0,2
00908	16 x 9	7,0	0,3
01023	25 x 8,5	7,5	0,4

**Schale „OLIVE“**bowl
cuenco
bol

aus geöltem Olivenholz

oiled olive wood

de madera de olivo aceitada

en bois d'olivier huilé



	cm	↑ cm	litr.
01013	7,5 x 7,5	2,5	0,05
01014	17,5 x 8,5	2,5	0,15
01015	26,5 x 11,5	5,0	0,60



Servierbeispiel - Lieferung ohne Gläser
delivery without glasses

Holzbox „TABLE“woodbox
caja madera
base bois

Akazienholz, 3 Fächer (6,5 x 6,5 cm) / acacia wood, 3 compartments (6,5 x 6,5 cm) / madera de acacia, 3 compartimentos (6,5 x 6,5 cm) / bois d'acacia, 3 compartiments (6,5 x 6,5 cm)



	cm	↑ cm	inner size cm
11727	23,5 x 8,5	4,5	6,5 x 6,5 je Fach / each compartment



Servierbeispiel - Lieferung ohne Gläser
delivery without glasses

Servierbrett „NARROW I“serving board
tabla de servir
planche de service

Akazienholz, mit 3 Vertiefungen Ø 4 cm / acacia wood, with 3 notches Ø 4 cm

madera de acacia, con 3 ranuras Ø 4 cm / bois d'acacia, avec 3 encoches Ø 4 cm



	cm	↑ cm
00864	22 x 8	1,5

passende Schälchen / fitting bowls / cuencos adecuados / bols appropriés

	Ø cm	↑ cm	litr.	
82359	5	3,5	0,035	glass / 12 pcs
82350	6	5,5	0,08	glass / 12 pcs
40685	6	3,0	0,05	stainless steel



Servierbeispiel - Lieferung ohne Schälchen
delivery without bowls

Servierbrett „NARROW II“serving board
tabla de servir
planche de service

Akazienholz, mit 3 Vertiefungen Ø 6 cm

acacia wood, with 3 notches Ø 6 cm

madera de acacia, con 3 ranuras Ø 6 cm

bois d'acacia, avec 3 encoches Ø 6 cm



	cm	↑ cm
00878	31 x 11	2

passende Schälchen / fitting bowls / cuencos adecuados / bols appropriés

	Ø cm	↑ cm	litr.	
40686	8	4,5	0,17	stainless steel





Buffet & Tableware Melamine



CRAZY WOOD.....	174	ZERO DRIFTWOOD.....	217
NERO.....	176	SLATE.....	218
LOOPS.....	180	SLATE ROCK.....	220
CANCUN.....	182	OAK.....	221
MOON.....	183	MARONE.....	222
EMMA.....	184	GLAMOUR.....	225
STONE ART.....	186	ASIA+.....	226
BAMBOO.....	189	APS+.....	229
BLUE OCEAN.....	190	HALFTONE.....	230
ARABESQUE.....	192	PURE.....	232
FOOTMARK.....	194	FLOAT.....	236
AIKO.....	195	SINUS APART CASCADE...238	
ELEMENT.....	196	GLOBAL BUFFET.....	239
DARK WAVE.....	198	BALANCE.....	241
MEDITERRANEAN.....	200	CASUAL.....	242
LA VIDA.....	200	MINI.....	244
ENAMEL LOOK.....	201	FLYING BUFFET.....	247
CROCKER.....	202	PARTY SPOON.....	248
ZEN.....	204	CUTLERY REST.....	250
FRIDA.....	208	GN CONTAINERS.....	251
OAK LIGHT.....	216		

NEW CRAZY WOOD



GN Tablett „CRAZY WOOD“

GN tray
GN bandeja
GN plateau



	cm	↑ cm	GN
85300	32,5 x 26,5	1	1/2
85301	32,5 x 17,6	1	1/3
85302	53 x 16,2	1	2/4



Präsentationsmöglichkeit
presentation example

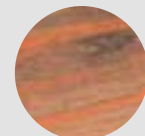

Farbstreifen in Orange
orange color stripes

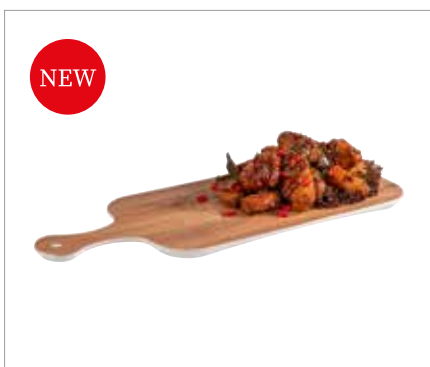

Tablett „CRAZY WOOD“

tray
bandeja
plateau



Servierfläche: 34 x 17,5 cm, Gesamtlänge: 45 cm, mit Hängeloch: Ø 0,8 cm
 serving area: 34 x 17,5 cm, total length: 45 cm, handle hole: Ø 0,8 cm
 superficie servicio: 34 x 17,5 cm, longitud total: 45 cm, con agujero para colgar: Ø 0,8cm
 surface de service: 34 x 17,5 cm, longueur totale: 45 cm, avec trou de suspension: Ø 0,8cm

	cm	↑ cm	Griff / handle cm
85303	45 x 17,5	1,5	11



Tablett „CRAZY WOOD“

tray
bandeja
plateau



Servierfläche: 40 x 20 cm, Grifflänge: 13 cm, Gesamtlänge: 53 cm, mit Hängeloch: Ø 0,8 cm
 serving area: 40 x 20 cm, total length: 53 cm, handle hole: Ø 0,8 cm
 superficie de servicio: 40 x 20 cm, longitud total: 53 cm, con agujero para colgar: Ø 0,8cm
 surface de service: 40 x 20 cm, longueur totale: 53 cm, avec trou de suspension: Ø 0,8cm

	Ø cm	↑ cm	Griff / handle cm
85304	53 x 20	1,5	13

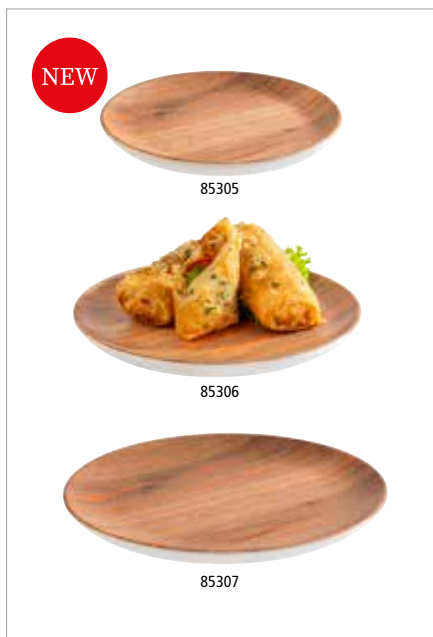

Teller „CRAZY WOOD“

plate
plato
assiette



	Ø cm	↑ cm
85305	15	1,5
85306	20	1,5
85307	26	2

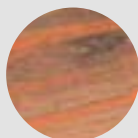

Farbstreifen in Orange
orange color stripes

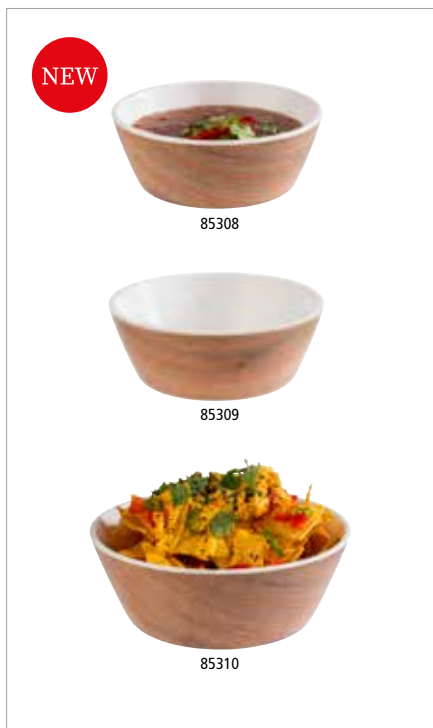

Schale „CRAZY WOOD“

bowl
cuenco
bol



	Ø cm	↑ cm	ltr.
85308	12,5	4,5	0,25
85309	12,5	5,5	0,5
85310	20,5	7,5	1,2

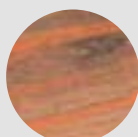

Farbstreifen in Orange
orange color stripes

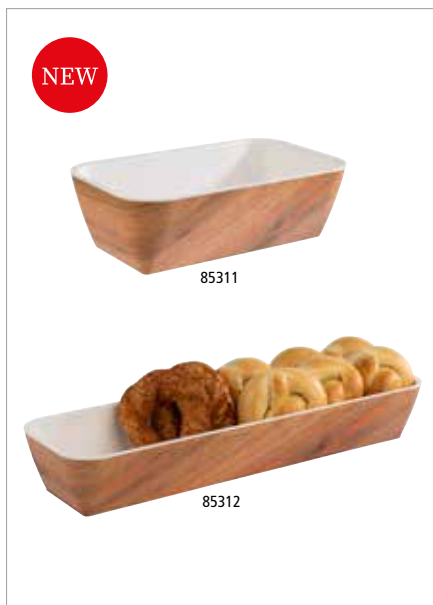

GN Schale „CRAZY WOOD“

GN bowl
GN cuenco
GN bol



	cm	↑ cm	ltr.	GN
85311	26,5 x 16,2	8	1,8	1/4
85312	53 x 16,2	8	4,0	2/4

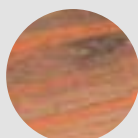

Farbstreifen in Orange
orange color stripes



NERO



GN Tablett „NERO“

GN tray
GN bandeja
GN plateau



	cm	↑ cm	GN
85067	53,0 x 32,5	2,5	1/1
85068	32,5 x 26,5	2,5	1/2
85275 NEW	53,0 x 16,2	2,5	2/4

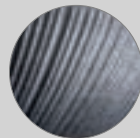

Teller „NERO“

plate
plato
assiette



	Ø cm	↑ cm
85073	15	3
85063	21	3
85064	26	3
85065	33	3,5
85066	42	3,5

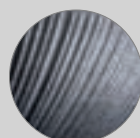



Teller „NERO“

plate
plato
assiette



	∅ cm	↑ cm	ltr.
85098	29	6	0,3



85069 0,5 ltr.

85070 0,9 ltr.

85061 1,7 ltr.

Schale „NERO“

bowl
cuenco
bol



	∅ cm	↑ cm	ltr.
85069	16	6,5	0,5
85070	19	8,0	0,9
85061	24	9,0	1,7

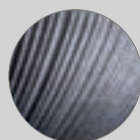

85060 0,8 ltr.

85062 2,2 ltr.

Schale „NERO“

bowl
cuenco
bol



	∅ cm	↑ cm	ltr.
85060	22,5	4,5	0,8
85062	30,0	7,0	2,2

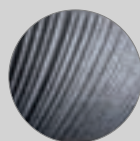

85274 0,6 ltr.

85071 1,5 ltr.

Schale „NERO“

bowl, square
cuenco, cuadrado
bol creux carré



	cm	↑ cm	ltr.
85274 <small>NEW</small>	16,5 x 16,5	5,5	0,6
85071	19,5 x 19,5	8	1,5
85072	25,0 x 25,0	11	3,5

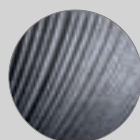



Teller „NERO“

plate
plato
assiette

mit integriertem Dipschälchen / Vertiefung
with integrated dip bowl / with notch
con cuenco para dip integrado / con ranura
avec ramequin intégré / avec encoche



	cm	↑ cm	ltr.
85074	24 x 20	2,5	0,04
85075	30 x 25	2,5	0,06

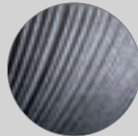

Tablett „NERO“

tray
bandeja
plateau

mit 2 integrierten Dipschälchen / Vertiefungen
with 2 integrated dip bowls / with 2 notches
con 2 cuencos para dip integrados / con 2 ranuras
avec 2 ramequins intégrés / avec 2 encoches



	cm	↑ cm	ltr.
85097	41 x 15	2,5	2 x 0,03



Schale „NERO“

bowl
cuenco
bol

	cm	↑ cm	ltr.
85076	23 x 18	5	0,6
85077	28 x 22	7	0,8

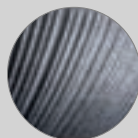

Schale „NERO“

bowl
cuenco
bol

	cm	↑ cm	ltr.
85092	14,5 x 12,5	8	0,3
85093	19,0 x 16,5	9	0,5

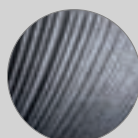



Schale „NERO“

bowl
cuenco
bol



	∅ cm	↑ cm	ltr.
85270	8,5	3,5	0,1



Schale „NERO“

bowl
cuenco
bol



	∅ cm	↑ cm	ltr.
85271	12,5	4,5	0,25
85272	15,5	5,5	0,45
85273	20,5	7,5	1,2

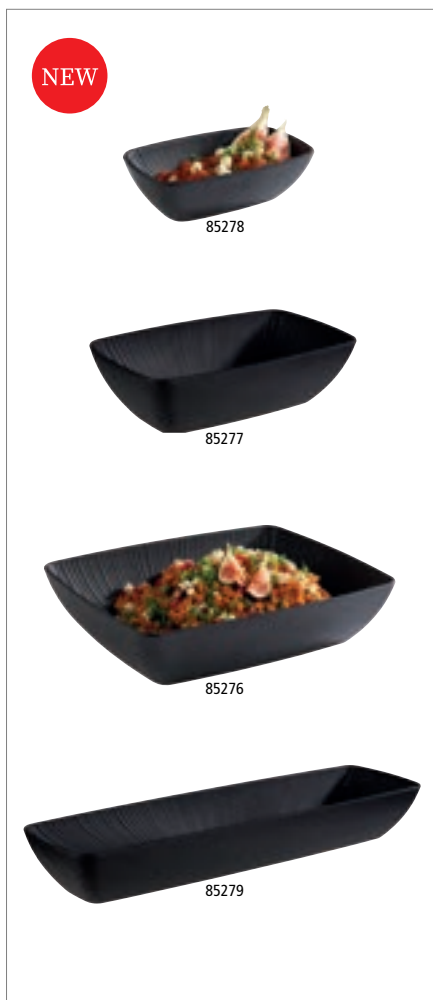
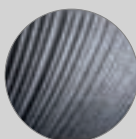

GN Schale „NERO“

GN bowl
GN cuenco
GN bol



	cm	↑ cm	ltr.	GN
85278	17,6 x 10,8	5,5	0,35	1/9
85277	26,5 x 16,2	7,5	1,5	1/4
85276	32,5 x 26,5	7,5	3,5	1/2
85279	53 x 16,2	7,5	3,5	2/4

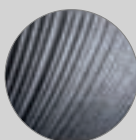



LOOPS

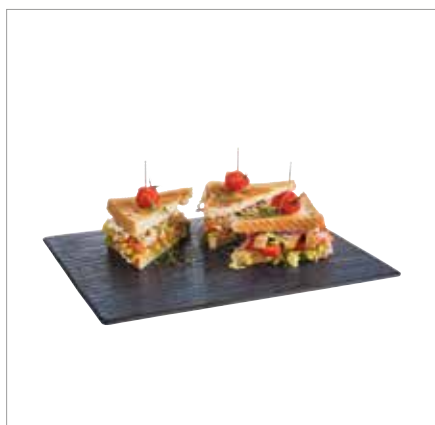

GN Tablett „LOOPS“

GN tray
GN bandeja
GN plateau



	cm	↑ cm	GN
85021	32,5 x 26,5	1,5	1/2

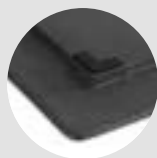

mit Antirutschfüßchen
with non-slip feet



Tablett/Sushiboard „LOOPS“

tray
bandeja
plateau



	cm	↑ cm
85025	23,5 x 13,5	1,5



85027

Teller „LOOPS“

plate
plato
assiette



	Ø cm	↑ cm
85027	22	2
85028	27	2



Teller „LOOPS“

plate
plato
plateau



	Ø cm	↑ cm
85024	34 x 15,5	4



Schale „LOOPS“

bowl
cuenco
bol



	Ø cm	↑ cm	ltr.
85026	18	3	0,25



Schale „LOOPS“

bowl
cuenco
bol



	Ø cm	↑ cm	ltr.
85029	20,5	6,5	1,0
85030	31,0	8,0	2,0



Schale „LOOPS“

bowl
cuenco
bol



	Ø cm	↑ cm	ltr.
85036	15,0	7,0	0,5
85037	18,5	8,0	1,0
85038	24,0	9,0	1,8



Teller „LOOPS“

plate
plato
assiette



	cm	↑ cm
85055	28 x 13,5	4,0



Teller „LOOPS“

plate
plato
assiette



	Ø cm	↑ cm
85056	23	3,5



Teller „LOOPS“

plate
plato
assiette



	Ø cm	↑ cm
85057	25,5	4,5



CANCUN



Tablett/Sushiboard „CANCUN“
tray/sushiboard
bandeja para sushi
plateau sushi



cm ↑ cm

85200 23,5 x 13,5 1,5



Teller „CANCUN“
plate
plato
assiette



cm ↑ cm

85201 28 x 13,5 4,0



Schale „CANCUN“
bowl
cuenco
bol



	Ø cm	↑ cm	ltr.
85205	15,0	7,0	0,5
85206	18,5	8,0	1,0
85207	20,5	6,5	1,0
85208	24,0	9,0	1,8



Teller „CANCUN“
plate
plato
assiette



	Ø cm	↑ cm
85202	18,0	3,0
85203	23,0	3,5



Teller „CANCUN“
plate
plato
assiette



	Ø cm	↑ cm
85204	25,5	4,5

MOON

6 tlg.
6 pcs.

85080



85081

Servierset „MOON“, 6-teilig

serving set, 6 pcs.

set para servir, set de 6

set de service, set de 6

6-teiliges Set: 3 Schalen + 3 Holzlöffel (Nanmu)

6 pcs.: 3 bowls + 3 wooden spoons (Nanmu)

set de 6: 3 cuencos + 3 cucharas de madera (Nanmu)

set de 6: 3 bols + 3 cuillères en bois (Nanmu)



	Ø cm	↑ cm	ltr.	Farbe / Colour
85080	8	7,5	0,05	
85081	8	7,5	0,05	

2 tlg.
2 pcs.

85082



85083

Servierset „MOON“, 2-teilig

serving set, 2 pcs.

set para servir, set de 2

set de service, set de 2

2-teiliges Set: 1 Schale + 1 klappbarer Deckel

2 pcs.: 1 bowl + 1 hinged cover

set de 2: 1 cuenco + 1 tapa con bisagra

set de 2: 1 bol + 1 couvercle avec charnières



	Ø cm	↑ cm	ltr.	Farbe / Colour
85082	19	17,5	0,8	
85083	19	17,5	0,8	



85083



85082

klappbarer Deckel
hinged coverPräsentationsmöglichkeit
presentation example

EMMA



85113

85116

85105

85104

85120

85101



85101 0,06 ltr



85104 0,50 ltr



85111 2,3 ltr

Schale „EMMA“ bowl cuenco bol



MAX
70°C



	Ø cm	↑ cm	ltr.	Farbe / Colour
85100	7,5	3,5	0,06	■
85101	7,5	3,5	0,06	■
85103	7,5	3,5	0,06	■
85104	14	6,5	0,5	■
85105	14	6,5	0,5	■
85107	14	6,5	0,5	■
85108	23	10,5	2,3	■
85109	23	10,5	2,3	■
85111	23	10,5	2,3	■

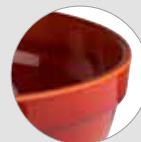
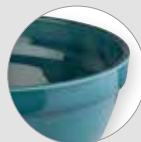

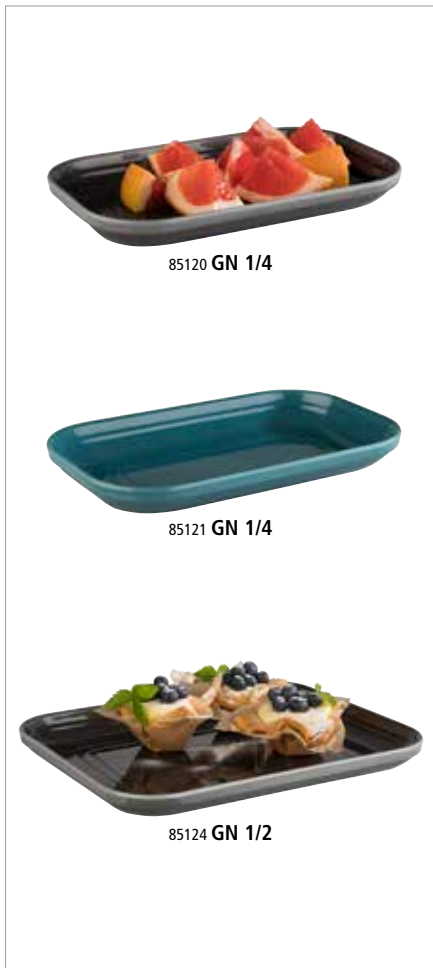

GN Tablett „EMMA“

GN tray
GN bandeja
GN plateau

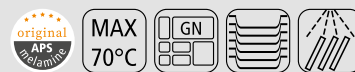

	cm	↑ cm	GN	Farbe / Colour
85120	26,5 x 16,2	3	1/4	■
85121	26,5 x 16,2	3	1/4	■
85124	32,5 x 26,5	3	1/2	■
85125	32,5 x 26,5	3	1/2	■

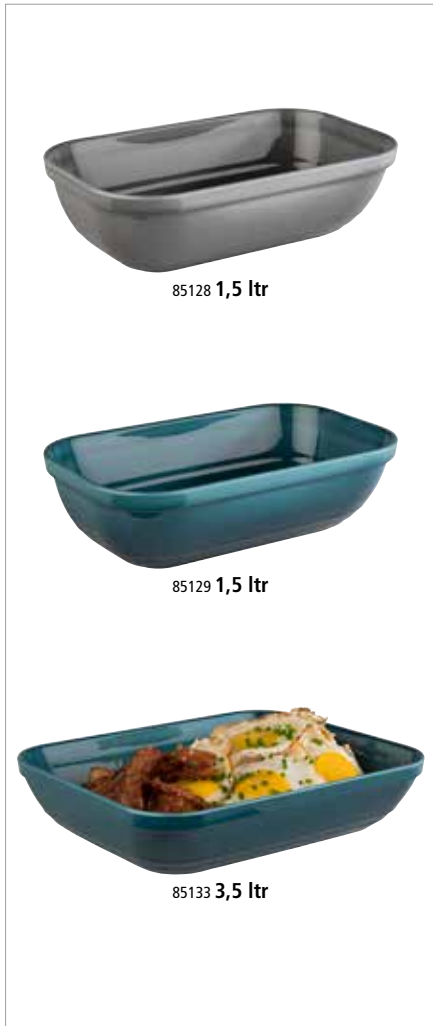
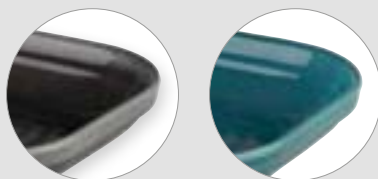

GN Schale „EMMA“

GN bowl
GN cuenco
GN bol

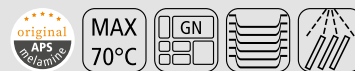

	cm	↑ cm	ltr.	GN	Farbe / Colour
85128	26,5 x 16,2	7,5	1,5	1/4	■
85129	26,5 x 16,2	7,5	1,5	1/4	■
85132	32,5 x 26,5	7,5	3,5	1/2	■
85133	32,5 x 26,5	7,5	3,5	1/2	■



❄️ Cooling bowl ❄️





STONE ART



84511

Teller „STONE ART“

plate
plato
assiette



	Ø cm	↑ cm
84510	19	2
84511	25	2
84512	30	2



84509

Teller „STONE ART“

plate
plato
assiette



	Ø cm	↑ cm	litr.
84509	15,5	2,5	0,15
84514	20,0	4,5	0,60



Teller „STONE ART“

plate
plato
assiette



	Ø cm	↑ cm
84515	24,5	3,5



Teller „STONE ART“

plate
plato
assiette



	cm	↑ cm
84517	33 x 32,5	3



Schale „STONE ART“

bowl
cuenco
bol



	∅ cm	↑ cm	ltr.	VE / unit
84523	8	3	0,07	12



Schale „STONE ART“

bowl
cuenco
bol



	∅ cm	↑ cm	ltr.
84524	12	6	0,3



Schale „STONE ART“

bowl
cuenco
bol



	∅ cm	↑ cm	ltr.
84525	15	7,5	0,6



Schale „STONE ART“

bowl
cuenco
bol



	cm	↑ cm	ltr.
84526	23 x 19	6,5	0,6



Schale „STONE ART“

bowl
cuenco
bol



	cm	↑ cm	ltr.
84528	28,5 x 21	7,5	1,2



84529

Schale „STONE ART“

bowl
cuenco
bol



	cm	↑ cm	ltr.
84529	19 x 19	6,0	0,5
84530	24 x 24	6,5	1,1

STONE ART



GN Tablett „STONE ART“

GN tray
GN bandeja
GN plateau



	cm	↑ cm	GN
84519	53,0 x 32,5	1,5	1/1
84520	32,5 x 26,5	1,5	1/2
84522	53,0 x 16,2	1,5	2/4
84521	32,5 x 17,6	1,5	1/3



mit Antirutschfüßchen
with non-slip feet



GN Abdeckhaube

GN cover
GN cubierta
GN cloche



passend für GN Tablett, glasklarer Kunststoff, nahezu unzerbrechlich

suitable for GN trays, clear plastic, nearly unbreakable

apto para bandejas GN, plástico transparente, muy resistente a la rotura

pour plateaux GN, plastique transparent, très résistant à la casse

	cm	↑ cm	✱ mm	GN
11043	32,5 x 17,6	10,5	3	1/3
11044	53,0 x 16,2	10,5	3	2/4

	cm	↑ cm	✱ mm	GN
11041	32,5 x 26,5	9,5	3	1/2
11042	53,0 x 32,5	9,5	3	1/1

BAMBOO



Schale „BAMBOO“

bowl
cuenco
bol



	cm	↑ cm	ltr.
84815	10,5 x 10,0	3,0	0,03
84816	17,5 x 15,5	5,5	0,2



Schale „BAMBOO“

bowl
cuenco
bol



	Ø cm	↑ cm	ltr.
84819	30,5	8,5	2

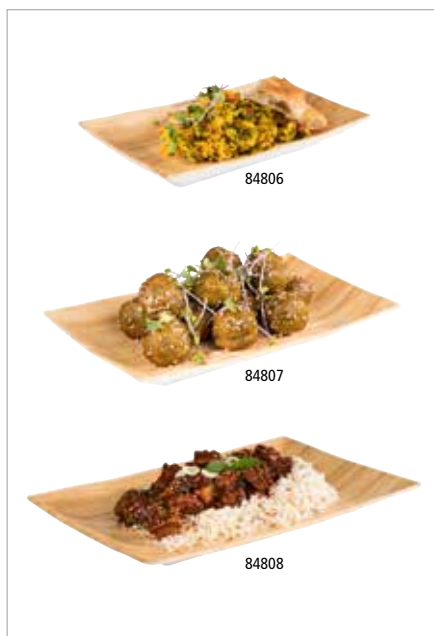

Tablett „BAMBOO“

tray
bandeja
plateau



	cm	↑ cm
84806	21,0 x 13,0	3,0
84807	24,5 x 15,5	3,0
84808	34,5 x 21,5	3,0

BLUE OCEAN



Da geht die Sonne auf!
Maritime Aquatöne, Farbverläufe und klassisches Blau-Weiß erinnern an eine griechische Taverne in der Ägäis.

The sun is rising!
Maritime aqua tones, gradients and classic blue and white reminiscent of a Greek tavern in the Aegean Sea.

¡Está saliendo el sol!
Los tonos marinos, los degradados de color, el clásico azul y blanco recuerdan a una taberna griega en el mar Egeo.

Le soleil se lève!
Les tons maritimes, les dégradés de couleurs, le bleu et le blanc classiques, tout rappellent une taverne grecque de la mer Égée.

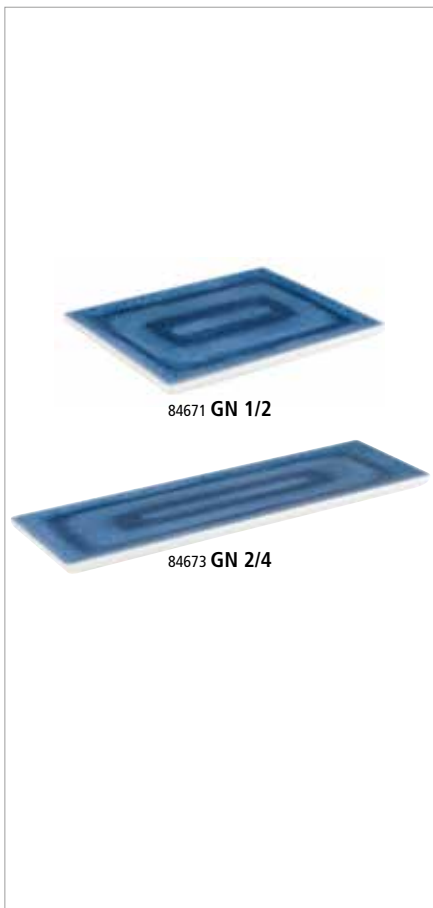

GN Tablett „BLUE OCEAN“

GN tray
GN bandeja
GN plateau



	cm	↑ cm	GN
84671	32,5 x 26,5	2	1/2
84672	32,5 x 17,6	2	1/3
84673	53,0 x 16,2	2	2/4

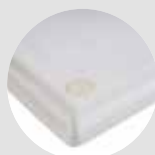

mit Antirutschfüßchen
with non-slip feet



Tablett „BLUE OCEAN“

tray
bandeja
plateau



	cm	↑ cm
84676	48 x 35,5	3



84677 0,6 ltr

84678 3,0 ltr

Schale „BLUE OCEAN“

bowl
cuenco
bol

	Ø cm	↑ cm	ltr.
84677	15	7,5	0,6
84678	30,5	9	3



84674

84675

Teller „BLUE OCEAN“

plate
plato
assiette



	Ø cm	↑ cm
84674	21,5	2
84675	26,5	2



84678



84677



84678

ARABESQUE



Beim Anblick der mediterranen Melamin Serie ARABESQUE bekommt man direkt Lust auf eine Tapas-Party. Mit seinem spanischen Charme und den wundervoll ausgearbeiteten Details holen Sie sich ein Stück Spanien auf Ihr Buffet.

When looking at the Mediterranean melamine series ARABESQUE, the longing for a tapas party resurfaces. With its Spanish charm and the beautifully crafted details, you get a slice of Spain on your buffet.

Al ver la serie mediterránea de melamina ARABESQUE, se obtiene un dicho antojo por una fiesta de tapas. Con su encanto español y los detalles bellamente elaborados, obtendrá un trozo de España en su buffet.

En regardant la série de mélamine méditerranéenne ARABESQUE, vous obtenez envie de préparer une fête de tapas. Avec son charme espagnol et les détails joliment ouvés, vous aurez une tranche d'Espagne sur votre buffet.



GN Tablett „ARABESQUE“

GN tray
GN bandeja
GN plateau



	cm	↑ cm	GN
84680	53,0 x 32,5	2	1/1
84681	32,5 x 26,5	2	1/2
84682	32,5 x 17,6	2	1/3
84683	53,0 x 16,2	2	2/4

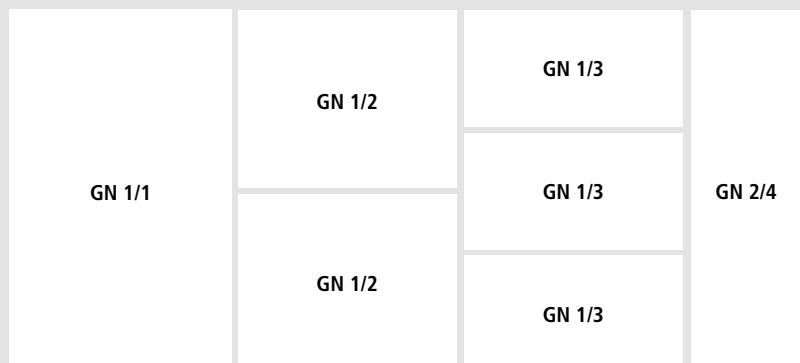



84687



84688



84689



84690

Schale „ARABESQUE“

bowl
cuenco
bol

	Ø cm	↑ cm	litr.
84687	10,0	6,0	0,2
84688	15,5	8,0	0,8

	Ø cm	↑ cm	litr.
84689	20,5	5,5	1,1
84690	31,0	9,0	3,0



Teller „ARABESQUE“

plate
plato
assiette

	cm	↑ cm
84686	38 x 15,5	2



84684



84685

Teller „ARABESQUE“

plate
plato
assiette

	Ø cm	↑ cm
84684	21,5	2
84685	26,5	2

NEW

FOOTMARK



NEW



85321

Schale „FOOTMARK“

bowl
cuenco
bol



MAX 70°C



	Ø cm	↑ cm	litr.
85320	13	5,5	0,25
85321	18	5,5	0,6

NEW



Teller, tief „FOOTMARK“

plate, deep
plato hondo
assiette creuse



MAX 70°C



	Ø cm	↑ cm	litr.
85322	24	4	0,8

NEW



85324

Teller „FOOTMARK“

plate
plato
assiette



MAX 70°C



	Ø cm	↑ cm
85323	21	2
85324	26,5	2,5

AIKO



Schalen der Serie Aiko eignen sich perfekt zum Präsentieren von leckeren Saucen, Pasten oder frischem Sushi. Aber auch kleines Fingerfood kann hübsch präsentiert und angerichtet werden.

Bowls from the Aiko series are perfect for presenting delicious sauces, pastes or fresh sushi. Also small finger food can be presented and served in a pretty way.

Los cuencos de la serie Aiko son perfectos para presentar deliciosas salsas, pastas o sushi fresco. Pero también se pueden presentar y servir de forma atractiva pequeños aperitivos.

Les bols de la série Aiko sont parfaits pour présenter de délicieuses sauces, des pâtes ou des sushis frais. Mais les petits apéritifs peuvent également être présentés et servis de manière attrayante.



84329 0,07 ltr.

84331 0,2 ltr.

Schale „AIKO“

bowl
cuenco
bol

Steinoptik

appearance stoneware
su aspecto recuerda al gres
l'aspect de la mélamine rapelle le grès



	Ø cm	↑ cm	ltr.	Farbe / Colour
84329	8,0	4	0,07	■
84331	11,5	6	0,20	■



84335 0,6 ltr.

84337 1,2 ltr.

Schale „AIKO“

bowl
cuenco
bol

Steinoptik

appearance stoneware
su aspecto recuerda al gres
l'aspect de la mélamine rapelle le grès



	Ø cm	↑ cm	ltr.	Farbe / Colour
84335	16,0	7	0,6	■
84337	20,5	8	1,2	■

ELEMENT



Betonoberflächen auf dem Buffet für den Kontakt mit Lebensmitteln?
ELEMENT macht es möglich.
 Bestens geeignet im modernen und urbanen Ausstattungsumfeld.

Concrete surfaces on the buffet for food contact?
ELEMENT makes it possible.
 Ideally suited for modern and urban environments.

¿Superficies de hormigón en el buffet y tener contacto con alimentos?
ELEMENT lo hace posible.
 Ideal para ambientes modernos y urbanos.

Des surfaces en béton sur le buffet et destinées au contact alimentaire?
ELEMENT le rend possible.
 Idéal pour les environnements modernes et urbains.



84825 **0,01 ltr.**

84826 **0,02 ltr.**

84820 **0,03 ltr.**

84821 **0,04 ltr.**

84827 **0,18 ltr.**

Schale „ELEMENT“

bowl
 cuenco
 bol



	cm	↑ cm	ltr.	VE / unit
84825	∅ 8,0	2,0	0,01	24
84826	10,5 x 10,0	3,0	0,02	24
84820	9,0 x 7,0	3,0	0,03	24
84821	10,5 x 10,5	3,0	0,04	12
84827	17,5 x 15,5	5,5	0,18	



82828 **0,5 ltr**

82829 **3,0 ltr**

Schale „ELEMENT“

bowl
 cuenco
 bol



	∅ cm	↑ cm	ltr.
84828	16	7	0,5
84829	28	12	3,0



82831 3,0 ltr

Schale „ELEMENT“

bowl
cuenco
bol



	cm	↑ cm	ltr.
84830	19 x 19	9	1,5
84831	25 x 25	12	3,8



Tablett „ELEMENT“

tray
bandeja
plateau



	cm	↑ cm
84824	31 x 10,5	1,5



GN Tablett „ELEMENT“

GN tray
GN bandeja
GN plateau



	cm	↑ cm	GN
84400	53,0 x 32,5	3,5	1/1
84401	32,5 x 26,5	3,5	1/2
84402	32,5 x 17,5	3,5	1/3
84403	26,5 x 16,2	3,5	1/4
84404	53,0 x 16,2	3,5	2/4



Schale „ELEMENT LOOK“

bowl
cuenco
bol



	Ø cm	↑ cm	ltr.
84835	21,5	5,5 / 9,5	0,7
84836	26,0	7,0 / 12,5	1,45
84837	30,0	8,5 / 14,5	2,3



1,45 ltr.

84836

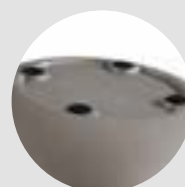

mit Antirutschfüßchen
with non-slip feet



DARK WAVE



GN Tablett „DARK WAVE“

GN tray
GN bandeja
GN plateau



	cm	↑ cm	GN
84900	53,0 x 32,5	2	1/1
84901	32,5 x 26,5	2	1/2
84902	32,5 x 17,6	2	1/3
84903	53,0 x 16,2	2	2/4

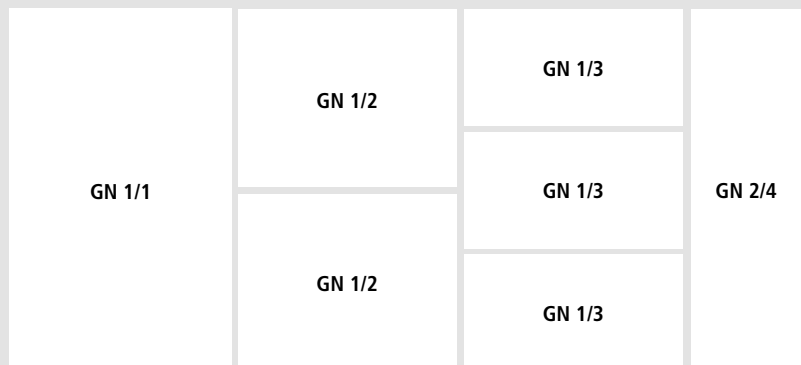

mit Antirutschfüßchen
with non-slip feet



Tablett „DARK WAVE“

tray
bandeja
plateau



	cm	↑ cm
84904	14 x 14	2



Tablett „DARK WAVE“

tray
bandeja
plateau



	cm	↑ cm
84905	23 x 10,5	1,5
84906	29 x 12,0	1,5



Teller „DARK WAVE“

plate
plato
assiette



	Ø cm	↑ cm
84907	14,5	1,5
84908	22,0	2,0
84909	27,0	2,5



Schale „DARK WAVE“

bowl
cuenco
bol



	Ø cm	↑ cm	litr.
84910	17,5	5,0	0,50
84911	22,5	5,0	0,75
84912	32,0	3,5	-



NEW MEDITERRANEAN



Schale / Teller „MEDITERRANEAN“
 bowl / plate
 cuenco / plato
 bol / assiette



	cm	↑ cm	litr.
85290	18,5 x 11,5	3	0,2



Präsentationsmöglichkeit
 presentation example

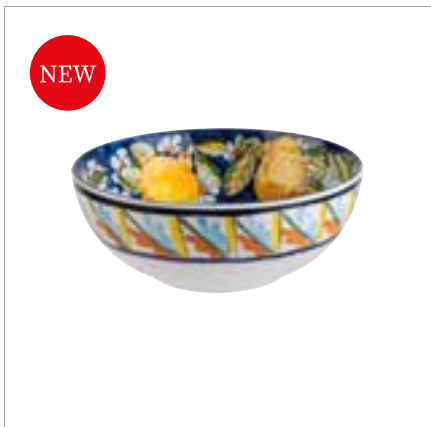

Schale „MEDITERRANEAN“
 bowl
 cuenco
 bol



	Ø cm	↑ cm	litr.
85291	20,5	8	1,2



Präsentationsmöglichkeit
 presentation example



LA VIDA



Tablett „LA VIDA“
 plate / tray
 plato / bandeja
 assiette / plateau



	Ø cm	↑ cm	Farbe / Colour
84161	32,0	3,5	
84170	40,5	5,5	
<hr/>			
	Ø cm	↑ cm	Farbe / Colour
84171	32,0	3,5	
84172	40,5	5,5	

ENAMEL LOOK



84951 Ø 24,5 cm



84958



84494

84490

84492



84950

84951

Teller „ENAMEL LOOK“

plate
plato
assiette



	Ø cm	↑ cm	Farbe / Colour
84950	20,5	2,0	
84951	24,5	2,5	



84958

84959

Schale „ENAMEL LOOK“

bowl
cuenco
bol



	cm	↑ cm	ltr.	Farbe / Colour
84958	15,0 x 11,5	6,5	0,30	
84959	21,5 x 16,5	9,5	1,00	



84490

84492

Schale „ENAMEL LOOK“

bowl
cuenco
bol



	Ø cm	↑ cm	ltr.	Farbe / Colour
84490	5,5	4,0	0,02	
84491	9,5	4,5	0,09	
84492	13,0	6,5	0,30	

CROCKER



Servier- und Buffetartikel in Tonoptik, brauner Rand. Die Oberfläche ist innen und außen fein-matt, fühlt sich an wie Ton.

Serving and buffet items, an imitation of clay, with a brown border. The surface is inside and outside fine-matt. Feels like real clay.

Artículos de servicio y buffet, imitación barro y con borde marrón. La superficie de dentro y de fuera es de deslustre fino. Parece barro natural.

Pièces de service et pour le buffet imitation argile avec bord marron. La surface est à l'intérieur et à l'extérieur bien-matte.



Teller „CROCKER“

plate
plato
assiette



	cm	↑ cm	Farbe / Colour
84567	14 x 13	2,5	
84568	14 x 13	2,5	



Teller „CROCKER“

plate
plato
assiette



	Ø cm	↑ cm	ltr.	Farbe / Colour
84575	20,5	3	0,50	
84576	20,5	3	0,50	



Schale „CROCKER“
bowl
cuenco
bol



	Ø cm	↑ cm	ltr.	Farbe / Colour
84573	16,5	4	0,50	
84574	16,5	4	0,50	



Schale „CROCKER“
bowl
cuenco
bol



	Ø cm	↑ cm	ltr.	Farbe / Colour
84569	12,5	6	0,37	
84570	12,5	6	0,37	
84571	16,0	7	0,70	
84572	16,0	7	0,70	
84577	21,0	8	1,45	
84578	21,0	8	1,45	



Blattschale „CROCKER“
leaf
fuente en forma de hoja
plateau feuille



	cm	↑ cm	ltr.	Farbe / Colour
84579	30,5 x 10	7,5	0,17	
84580	30,5 x 10	7,5	0,17	
84581	42 x 14	9,5	0,65	
84582	42 x 14	9,5	0,65	

ZEN



Fernöstliche Tisch- und Buffetartikel präsentiert die Serie ZEN. Die Optik entspricht dem japanischen Steingut.

The ZEN series presents Far Eastern table and buffet articles. The appearance is that of Japanese stoneware.

La colección ZEN presenta artículos de buffet y mesa para la cocina oriental. Su aspecto recuerda al gres japonés.

La collection ZEN présente des articles de buffet et de table pour la cuisine orientale. L'aspect de la mélamine rappelle le grès japonais.



Schale „ZEN“

bowl
cuenco
bol



MAX
70°C



	Ø cm	↑ cm	ltr	Farbe / Colour
83929	31	8,5	2,5	■

Schale „ZEN“

bowl
cuenco
bol



MAX
70°C



	Ø cm	↑ cm	ltr	Farbe / Colour
84355	22,5	12,5	0,80	■



Schale „ZEN“

bowl
cuenco
bol



MAX
70°C



	cm	↑ cm	ltr	Farbe / Colour
83712	21 x 21	11	1,40	■





Schale „ZEN“

bowl
cuenco
bol

	Ø cm	↑ cm	ltr.	Farbe / Colour
84348	10,0	7,0	0,08	■
84349	10,0	7,0	0,08	■
84351	12,5	8,5	0,15	■
84353	16,0	10,0	0,30	■

stapelbar
stackable

Schale „ZEN“

bowl
cuenco
bol

	cm	↑ cm	ltr.	Farbe / Colour
83735	25,0 x 13,5	4	0,25	■
83739	30,5 x 17,5	5	0,60	■



Schale „ZEN“

bowl
cuenco
bol

	cm	↑ cm	ltr.	Farbe / Colour
83716	17,5 x 17,5	7	0,5	■



Schale „ZEN“

bowl
cuenco
bol

	cm	↑ cm	ltr.	Farbe / Colour
83725	10,5 x 10,5	3	0,06	■
83727	10,5 x 10,5	3	0,06	■



Dipschälchen „ZEN“

dip bowl
cuenco para dip
bol para dip

	Ø cm	↑ cm	ltr.	Farbe / Colour	VE / unit
83721	8	1,5	0,03	■	24
83723	8	1,5	0,03	■	24



Schale „ZEN“

bowl
cuenco
bolMAX
70°C

	cm	↑ cm	ltr.	Farbe / Colour
83718	12 x 12	4	0,2	■
83720	12 x 12	4	0,2	■



Schale „ZEN“

bowl
cuenco
bolMAX
70°C

	cm	↑ cm	ltr.	Farbe / Colour
83726	13 x 11	3,5	0,1	■
83728	13 x 11	3,5	0,1	■



Schale „ZEN“

bowl
cuenco
bolMAX
70°C

	cm	↑ cm	ltr.	Farbe / Colour
83730	11 x 10	3	0,04	■
83732	11 x 10	3	0,04	■



Schale „ZEN“

bowl
cuenco
bolMAX
70°C

	cm	↑ cm	ltr.	Farbe / Colour
83722	17,5 x 15,5	5,5	0,2	■
83724	17,5 x 15,5	5,5	0,2	■



Schale „ZEN“

bowl
cuenco
bolMAX
70°C

	cm	↑ cm	ltr.	Farbe / Colour
83935	14,5 x 12,5	5	0,2	■



Schale „ZEN“

bowl
cuenco
bolMAX
70°C

	Ø cm	↑ cm	ltr.	Farbe / Colour
83932	11,5	4	0,15	■
83933	11,5	4	0,15	■



83946

Schale „ZEN“bowl
cuenco
bolMAX
70°C

	cm	↑ cm	ltr.	Farbe / Colour
83946	9 x 7	2,5	0,05	■
83947	9 x 7	2,5	0,05	■

**Schale „ZEN“**bowl
cuenco
bolMAX
70°C

	cm	↑ cm	Farbe / Colour
83949	14 x 9	2,5	■

**Tablett / Teller „ZEN“**tray / plate
bandeja / plato
plateau / assietteMAX
70°C

	Ø cm	↑ cm	Farbe / Colour
83941	28	3	■



83742

Tablett / Sushiboard „ZEN“tray / sushiboard
bandeja para sushi
plateau sushiMAX
70°C

	cm	↑ cm	Farbe / Colour
83742	22,5 x 9,5	3	■
83744	22,5 x 9,5	3	■

**Tablett / Sushiboard „ZEN“**tray / sushiboard
bandeja para sushi
plateau sushiMAX
70°C

	cm	↑ cm	Farbe / Colour
83740	22 x 12	3	■

FRIDA



FRIDA





Schale „FRIDA LOCK“

bowl
cuenco
bol



Schalen lassen sich durch Drehmechanismus mit dem Ständer fest verbinden

bowls can be firmly connected to the stand by a turning mechanism

los cuencos se pueden conectar firmemente al soporte mediante un mecanismo giratorio

les bols peuvent être solidement reliés au présentoir au moyen d'un mécanisme rotatif

	Ø cm	↑ cm	ltr.	Farbe / Colour
84920	21,5	7/8,5	1,0	
84921	21,5	7/8,5	1,0	
84922	25,0	8/11	1,6	
84923	25,0	8/11	1,6	
84924	28,5	10/14	2,6	
84925	28,5	10/14	2,6	

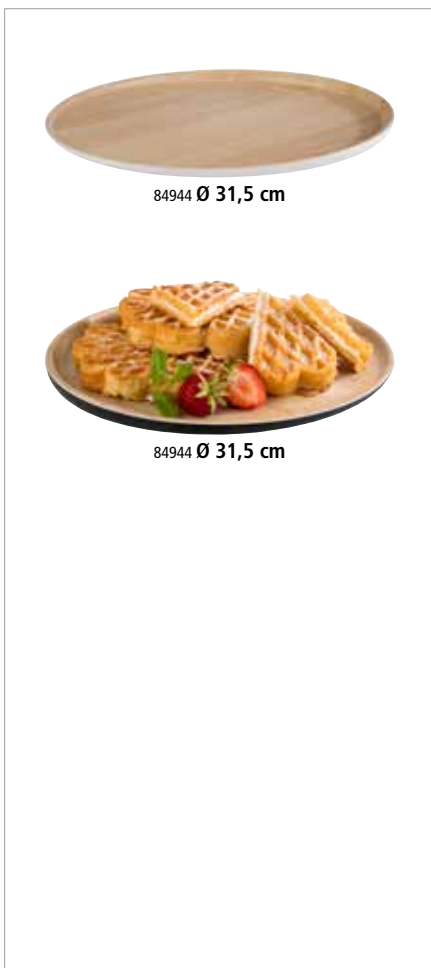

Tablett / Platte „FRIDA LOCK“

tray
bandeja
plateau



Tabletts lassen sich durch Drehmechanismus mit dem Ständer fest verbinden

trays can be firmly connected to the stand by a turning mechanism

las bandejas se pueden conectar firmemente al soporte mediante un mecanismo giratorio

les plateaux peuvent être solidement reliés au présentoir au moyen d'un mécanisme rotatif

	Ø cm	↑ cm	Farbe / Colour
84943	31,5	1,5/2,5	
84944	31,5	1,5/2,5	





Ständer „FRIDA LOCK“

stand
soporte
présentoir



	Ø cm	↑ cm	Farbe / Colour
84926	16,5	8	White
84927	16,5	8	Black



Ständer „FRIDA LOCK“

stand
soporte
présentoir



	Ø cm	↑ cm	Farbe / Colour
84928	16,5	12	White
84929	16,5	12	Black



Haube

cover
campana
cloche



	Ø cm	↑ cm	fits to
06519	21	17	
06520	30	22	00468, 00469, 84943, 84944
06521	36	27	
	Ø cm	↑ cm	fits to
06525	30	40	00468, 00469, 84943, 84944

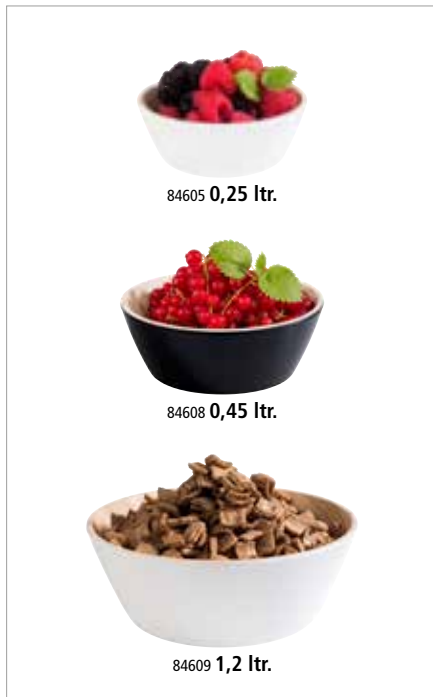

Schale „FRIDA“

bowl
cuenco
bol



	Ø cm	↑ cm	ltr.	Farbe / Colour
84605	12,5	4,5	0,25	
84606	12,5	4,5	0,25	
84607	15,0	5,5	0,44	
84608	15,0	5,5	0,44	
84609	20,0	7,5	1,20	
84610	20,0	7,5	1,20	

passende Deckel / suitable lid / tapa adecuada / couvercle approprié

	Ø cm	↑ cm	fits to
84963	13,0	2,5	84605, 84606
84964	16,0	2,5	84607, 84608



Schale „FRIDA“

bowl
cuenco
bol



	Ø cm	↑ cm	ltr.	Farbe / Colour
84611	22,0	10,5	2,2	
84612	22,0	10,5	2,2	
84613	26,5	10,5	3,4	
84614	26,5	10,5	3,4	

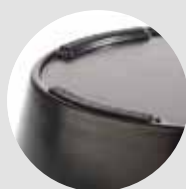

mit Antirutschfüßchen
with non-slip feet

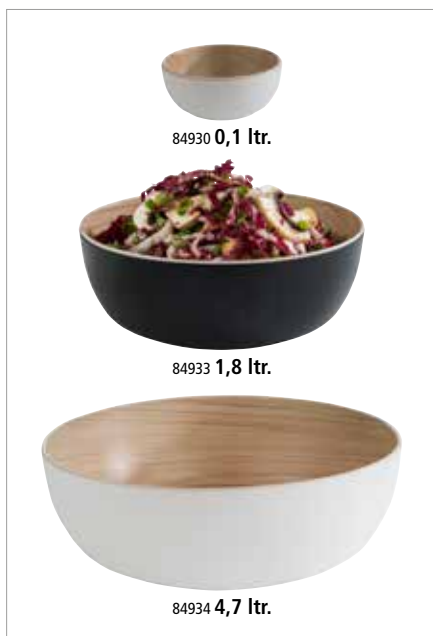

Schale „FRIDA“

bowl
cuenco
bol



	Ø cm	↑ cm	ltr.	Farbe / Colour
84930	8,5	3,5	0,1	
84931	8,5	3,5	0,1	
84932	21,5	7,5	1,8	
84933	21,5	7,5	1,8	
84934	30,0	9,5	4,7	
84935	30,0	9,5	4,7	

passende Deckel / suitable lid / tapa adecuada / couvercle approprié

	Ø cm	↑ cm	fits to
84962	9,0	2,5	84930, 84931



84936 0,37 ltr.



84959 0,85 ltr.



84561 2,65 ltr.

Schale „FRIDA“

bowl
cuenco
bol

	cm	↑ cm	ltr.	Farbe / Colour
84936	12,5 x 12,5	4,5	0,37	
84937	12,5 x 12,5	4,5	0,37	
84558	16,5 x 16,5	5,5	0,85	
84559	16,5 x 16,5	5,5	0,85	
84561	25,0 x 25,0	7,5	2,65	
84562	25,0 x 25,0	7,5	2,65	

passende Deckel / suitable lid / tapa adecuada / couvercle approprié

	cm	↑ cm	fits to
84965	13,0 x 13,0	2,5	84936, 84937
84966	17,0 x 17,0	2,5	84558, 84559



84555 GN 1/9



84584 GN 1/6



84586 GN 1/4



84565 GN 2/4



84589 GN 1/2

GN Schale „FRIDA“

GN bowl
GN cuenco
GN bol

	cm	↑ cm	ltr.	GN	Farbe / Colour
84555	17,6 x 10,8	5,5	1,5	1/9	
84556	17,6 x 10,8	5,5	1,5	1/9	
84583	17,6 x 16,2	7,5	1,0	1/6	
84584	17,6 x 16,2	7,5	1,0	1/6	
84586	26,5 x 16,2	7,5	1,8	1/4	
84587	26,5 x 16,2	7,5	1,8	1/4	
84564	53 x 16,2	7,5	3,65	2/4	
84565	53 x 16,2	7,5	3,65	2/4	
84589	32,5 x 26,5	7,5	4,0	1/2	
84590	32,5 x 26,5	7,5	4,0	1/2	

passende Deckel / suitable lid / tapa adecuada / couvercle approprié

	cm	↑ cm	fits to
84968	18,0 x 11,0	2,5	84555, 84556
84967	18,0 x 16,5	2,5	84583, 84584





84592 3,5 ltr.

84593 3,5 ltr.

83601

Schale „FRIDA“

bowl
cuenco
bol



	cm	↑ cm	ltr.	Farbe / Colour
84592	25 x 25	12	3,5	white
84593	25 x 25	12	3,5	black

Deckel „PURE“ mit Löffelaussparung

cover with notched for spoons
tapa con espacio para la cuchara
couvercle avec encoche pour la louche



	cm	↑ cm	fits to
83601	25 x 25	1,5	84561, 84562, 84592, 84593



mit Deckel stapelbar
stackable with cover



84548 1,2 ltr.

Schale „FRIDA“

bowl
cuenco
bol



	cm	↑ cm	ltr.	Farbe / Colour
84948	33,5 x 21	4	1,2	black



als Schütte geeignet
suitable as a chute

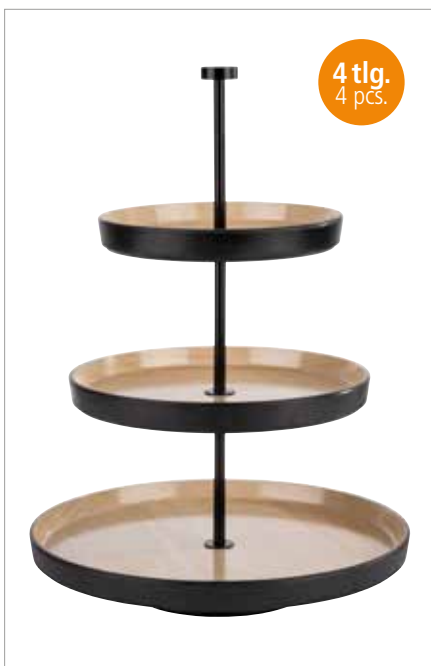

4 tlg.
4 pcs.

3-stufige Etagère „FRIDA“

3-tier tray
bandeja con 3 alturas
étagère carré 3 hauteurs



1 Gestell aus Edelstahl, schwarz, 3 Schalen aus Melamin: Ø 20 / 25 / 32 cm
1 stainless steel frame, black, 3 melamine bowls: Ø 20 / 25 / 32 cm
1 soporte de acero inoxidable, negro, 3 cuencos de melamina: Ø 20 / 25 / 32 cm
1 support en acier inox, noir, 3 bols en mélamine: Ø 20 / 25 / 32 cm

	Ø cm	↑ cm	Farbe / Colour
85211	20 / 25 / 32	43	black

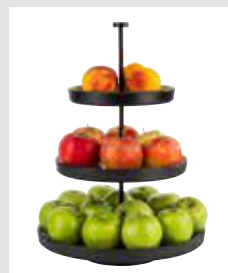

2 tlg.
2 pcs.

85230 Ø 25,5 cm



+



33282

+



85231 Ø 33 cm

**Schale, 2-teilig „FRIDA“**bowl, 2 pcs.
cuenco, set de 2
bol, set de 2**inklusive Abtropfeinsatz**including drip tray
con escurridor
avec égouttoir

	Ø cm	↑ cm	Farbe / Colour
85230	25,5	6	■ ■
85231	33,0	6	■ ■

Buffetständerbuffet stand
soporte para buffet
présentoir buffet**Metall, mit schwarzer Antirutschbeschichtung, für Schalen Nr. 85230, 85231**

metal, with black anti-slide coating, for bowls no. 85230, 85231

metal, con revestimiento antideslizante negro, para cuencos 85230, 85231

métal, avec revêtement antidérapant noir, pour bols 85230, 85231

	Ø cm	↑ cm	Farbe / Colour
33282	23 / 30,5	17	■

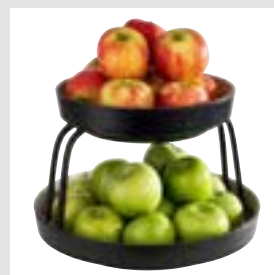
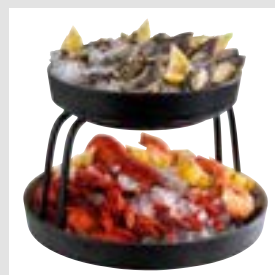
Präsentationsmöglichkeit
presentation exampleinklusive Abtropfeinsatz
including drip tray

OAK LIGHT



84205 GN 1/1



84206 GN 1/2



84207 GN 1/3



84209 GN 2/4

GN Tablett „OAK LIGHT“

GN tray
GN bandeja
GN plateau



	cm	↑ cm	GN
84205	53,0 x 32,5	1,5	1/1
84206	32,5 x 26,5	1,5	1/2
84207	32,5 x 17,6	1,5	1/3
84209	53,0 x 16,2	1,5	2/4



84205
GN 1/1



84206
GN 1/2



84206
GN 1/2



84209
GN 2/4



GN Tablett „ZERO“

GN tray
GN bandeja
GN plateau

glatte, hochglänzende Oberfläche
smooth and shiny surface
superficie lisa con acabado brillante
surface lisse et finition brillante



	cm	↑ cm	GN	Farbe / Colour
84185	53,0 x 32,5	1,5	1/1	
84186	32,5 x 26,5	1,5	1/2	
84187	32,5 x 17,6	1,5	1/3	
84188	26,5 x 16,2	1,5	1/4	
84189	53,0 x 16,2	1,5	2/4	

passende Hauben / suitable covers / campanas adecuadas / cloches appropriées

	cm	↑ cm	* mm	GN
11042	53,0 x 32,5	9,5	3	1/1
11041	32,5 x 26,5	9,5	3	1/2
11043	32,5 x 17,6	10,5	3	1/3
11044	53,0 x 16,2	10,5	3	2/4



mit Antirutschfüßchen
with non-slip feet



GN Tablett „DRIFTWOOD“

GN tray
GN bandeja
GN plateau

die Melaminplatten (Holzoptik) haben eine leicht wellige Oberfläche und wirken optisch wie aus Holz gefertigt

the melamine trays (wood look) have a slightly wavy surface and look visually as made of natural wood

las bandejas de melamina (imitación madera) tienen una superficie ligeramente ondulada y parecen estar hechas de madera natural

les plateaux de mélamine (imitation bois) ont une surface légèrement ondulée et donnent une impression visuelle de bois naturelle



	cm	↑ cm	GN
84180	53,0 x 32,5	1,5	1/1
84181	32,5 x 26,5	1,5	1/2
84182	32,5 x 17,6	1,5	1/3



Oberflächenansicht
surface view

SLATE



Die schwarzen Melaminplatten überzeugen mit ihrem edlen und schlichten Schieferlook und einer rauhen Oberfläche.

The black melamine trays convince with their noble and simple slate look and a rough surface.

Las bandejas de melamina negras convencen por su aspecto de pizarra elegante y discreto y una superficie áspera.

Les plateaux en mélamine noirs convainquent grâce au aspect de l'ardoise élégant et discret et une surface rugueuse.



GN Tablett „SLATE“

GN tray
GN bandeja
GN plateau



	cm	↑ cm	GN
83955	53,0 x 32,5	1	1/1
83956	32,5 x 26,5	1	1/2
83957	32,5 x 17,6	1	1/3
83958	26,5 x 16,2	1	1/4
83971	53,0 x 16,2	1	2/4



GN Tablett „SLATE“

GN tray
GN bandeja
GN plateau

massive Metallgriffe verchromt inkl. fest verschraubten 4 cm Distanzstücken
chrome plated handles, incl. mounted 4 cm distance pillars
asas cromadas, incluye distanciadores de 4 cm firmemente montados
poignées chromées, y compris piliers de distance montées de 4 cm



	cm	↑ cm	GN
83980	53 x 32,5	6	1/1



GN Tablett „SLATE“

GN tray
GN bandeja
GN plateau

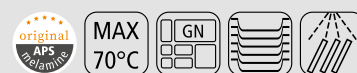

	cm	↑ cm	GN
83981	53 x 32,5	1,5	1/1



Schieferoptik
slate look



83994

Tablett „SLATE“

tray
bandeja
plateau



	Ø cm	↑ cm
83992	30	1
83994	40	1



11056

85099

30336

Tablett „SLATE“

tray
bandeja
plateau

passend zu Etagère 30336
suitable for 2-tier tray 30336
adecuado para soporte 2 alturas 30336
adapté à étagère 2 niveaux



	cm	↑ cm
85099	28,0 x 15,5	1,0



Haube / cover / campana / cloche

	cm	↑ cm
11056	26,0 x 12,0	10,0



84245

83601

83600

Schale „SLATE“

bowl
cuenco
bol



	cm	↑ cm	litr.
84244	19 x 19	9	1,5
84245	25 x 25	12	3,8

Deckel „PURE“ mit Löffelaussparung
cover with notched for spoons
tapa con espacio para la cuchara
couverture avec encoche pour la louche

	cm	↑ cm	fits to
83600	19 x 19	1,5	84244
83601	25 x 25	1,5	84245

SLATE ROCK



Tablett „SLATE-ROCK“

tray
bandeja
plateau



Die schwarzen Melaminplatten überzeugen mit ihrem Schieferlook
The black melamine trays convince with their slate look
Las bandejas de melamina negras convencen por su aspecto de pizarra
Les plateaux en mélamine noirs convainquent grâce au aspect de l'ardoise

	cm	↑ cm	Griff / handle cm
84258	40 x 20	1,5	13
84259	48 x 20	1,5	13
	Ø cm	↑ cm	Griff / handle cm
84257	30	1,5	12

OAK



84178



84179

Tablett „OAK“

tray
bandeja
plateau

	cm	↑ cm	Griff / handle cm
84178	40 x 20	1,5	13
84179	48 x 20	1,5	13



Tablett „OAK“

tray
bandeja
plateau

	Ø cm	↑ cm	Griff / handle cm
84177	30	1,5	12



Schale „OAK“

bowl
cuenco
bol

	cm	↑ cm	VE / unit
84434	11,5 x 7,0	2,5	20



Eine derbe Oberflächenstruktur schafft ein natürliches Erscheinungsbild.
Die schwarzen Schalenvarianten mit braunem Rand inszenieren Ihr Gericht sehr stilvoll.

A rough surface structure creates a natural appearance.
The black bowls and trays with brown border stage your dishes in a very stylish way.

La estructura rugosa de la superficie crea una apariencia natural.
Los diferentes cuencos negros con borde marron ponen con mucho estilo en escena sus platos.

La structure de surface rugueuse crée une apparence naturelle.
Les différents bols noirs avec rebord marron mettent élégamment en scène vos plats.



Blattschale „MARONE“
leaf
fuente en forma de hoja
plateau feuille



	cm	↑ cm	ltr.
84100	25,5 x 14	5,5	0,4
84101	36,0 x 19	8,0	0,9



Schale „MARONE“
bowl
cuenco
bol



	cm	↑ cm	ltr.
84731	16,5 x 10	5,5	0,25
84732	22,0 x 13	7,5	0,6
84733	27,5 x 19	9,0	1,4



Oberflächenansicht
surface view



84107 **0,05 ltr.**



84108 **0,04 ltr.**

Schale „MARONE“

bowl
cuenco
bol



	Ø cm	↑ cm	ltr.	VE / unit
84107	8,5	2,5	0,05	12
84108	11,5	3,0	0,04	12



84115 **0,13 ltr.**



84116 **0,2 ltr.**

Schale „MARONE“

bowl
cuenco
bol



	Ø cm	↑ cm	ltr.
84115	11	3,5	0,13
84116	14	4,0	0,20



84109 **0,2 ltr.**

Schale „MARONE“

bowl
cuenco
bol



	Ø cm	↑ cm	ltr.
84109	11	5,5	0,2



84111 **0,8 ltr.**

Schale „MARONE“

bowl
cuenco
bol



	Ø cm	↑ cm	ltr.
84110	14	6,0	0,30
84111	19	8,0	0,80
84112	21	8,5	1,00
84113	24	9,5	1,40



84174 **2,0 ltr.**

Schale „MARONE“

bowl
cuenco
bol



	Ø cm	↑ cm	ltr.
84174	30,5	8,5	2

MARONE



Tablett „MARONE“

tray
bandeja
plateau



MAX
70°C



	cm	↑ cm
84117	19,5 x 9,5	2
84118	39,0 x 16,0	3



Tablett „MARONE“

tray
bandeja
plateau



MAX
70°C



	cm	↑ cm
84119	32,5 x 23,5	4,5



Tablett „MARONE“

tray
bandeja
plateau



MAX
70°C



	cm	↑ cm
84104	22,5 x 15	3
84105	27,5 x 11	2



Tablett „MARONE“

tray
bandeja
plateau



MAX
70°C



	cm	↑ cm
84103	14,5 x 14,5	2



Tablett „MARONE“

tray
bandeja
plateau



MAX
70°C



	cm	↑ cm
84106	26,5 x 16,5	4



Teller „MARONE“

plate
plato
assiette



MAX
70°C



	Ø cm	↑ cm
84729	20,5	2,5
84730	28,0	3,5

GLAMOUR



84377

84381



Schale „GLAMOUR“

bowl
cuenco
bol



	Ø cm	↑ cm	ltr.
84365	8	3	0,05



Schale „GLAMOUR“

bowl
cuenco
bol



	Ø cm	↑ cm	ltr.
84366	12	5	0,25

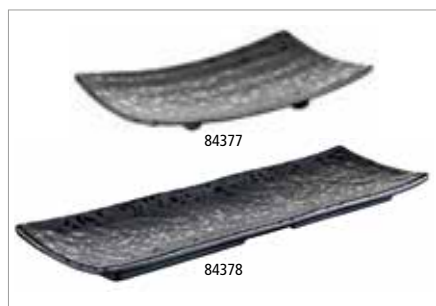

84377

84378

Tablett „GLAMOUR“

tray
bandeja
plateau



	cm	↑ cm
84377	22 x 12	3,0
84378	37 x 11	2,5

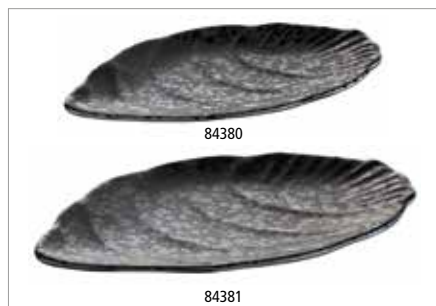

84380

84381

Tablett „GLAMOUR“

tray
bandeja
plateau



	cm	↑ cm
84380	25,0 x 15,5	1,5
84381	30,5 x 19,0	1,5



Tablett „GLAMOUR“

tray
bandeja
plateau



	cm	↑ cm
84379	30 x 11	3



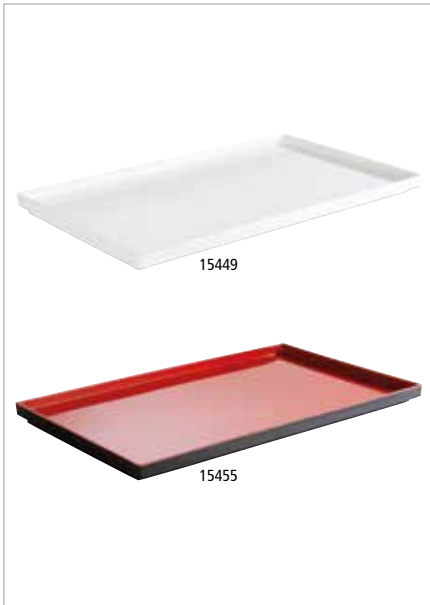

GN Tablett „ASIA PLUS“

GN tray
GN bandeja
GN plateau

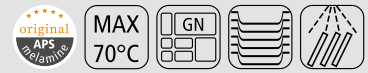

	cm	↑ cm	GN	Farbe / Colour
15449	53,0 x 32,5	3	1/1	White
15450	32,5 x 26,5	3	1/2	White
15451	32,5 x 17,6	3	1/3	White
15452	26,5 x 16,2	3	1/4	White
15453	35,4 x 32,5	3	2/3	White
15454	53,0 x 16,2	3	2/4	White
15455	53,0 x 32,5	3	1/1	Red/Black
15456	32,5 x 26,5	3	1/2	Red/Black
15457	32,5 x 17,6	3	1/3	Red/Black
15458	26,5 x 16,2	3	1/4	Red/Black
15460	53,0 x 16,2	3	2/4	Red/Black



Schale „ASIA PLUS“

bowl
cuenco
bol



	Ø cm	↑ cm	ltr.	Farbe / Colour
15400	7,5	3,5	0,06	White
15401	9,5	4,5	0,13	White
15402	13,0	5,5	0,35	White
15403	16,0	7,0	0,60	White
15404	20,0	8,0	1,10	White
15416	7,5	3,5	0,06	Red/Black
15417	9,5	4,5	0,13	Red/Black
15418	13,0	5,5	0,35	Red/Black
15419	16,0	7,0	0,60	Red/Black
15420	20,0	8,0	1,10	Red/Black
15421	24,0	9,5	2,20	Red/Black



Teller „ASIA PLUS“

plate
plato
assiette



	Ø cm	↑ cm	Farbe / Colour
15424	11,0	2	White
15425	16,0	2	White



Bento Box „ASIA PLUS“

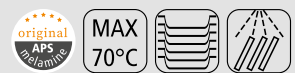

	Ø cm	↑ cm	ltr.	Farbe / Colour
15461	7,5	3,0	0,04	White
15462	7,5	6,5	0,13	White
15467	7,5	3,0	0,04	Red/Black



Bento Box „ASIA PLUS“



	cm	↑ cm	ltr.	Farbe / Colour
15473	7,5 x 7,5	3,0	0,05	White
15474	7,5 x 7,5	6,5	0,16	White
15485	7,5 x 7,5	3,0	0,05	Black/Red
15475	15,5 x 7,5	3,0	0,10	White
15477	15,5 x 9,5	3,0	0,15	White

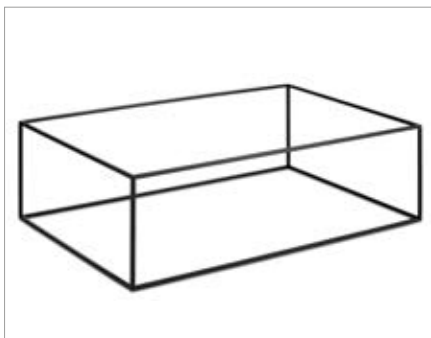

GN Buffetständer „ASIA PLUS“



GN buffet stand
GN soporte para buffet
GN présentoir buffet

	cm	GN	Farbe / Colour
15504	53,0 x 32,5 / 53,0 x 16,2	1/1 / 2/4	Black
15505	32,5 x 26,5 / 26,5 x 16,2	1/2 / 1/4	Black
15506	32,5 x 17,5 / 35,4 x 32,5	1/3 / 2/3	Black

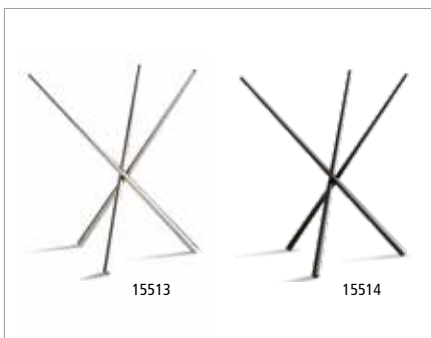

Buffetständer „ASIA PLUS“



buffet stand
soporte para buffet
présentoir buffet

	Ø cm	↑ cm	Farbe / Colour
15513	20,5 / 16,5	20	stainless steel
15514	20,5 / 16,5	20	Black



Korb / Ständer „APS PLUS“



basket / riser
cesta / soporte
corbeille / support

	Ø cm	↑ cm	Farbe / Colour
15320	10,5 / 8	8	polished chrome
15324	10,5 / 8	8	brushed gold
15322	10,5 / 8	8	brushed copper

APS+



15215 0,6 ltr.



15216 1,5 ltr.



15217 3,5 ltr.

Schale „APS+“
bowl
cuenco
bol



	cm	↑ cm	ltr.	Farbe / Colour
15215	13,0 x 13,0	7	0,6	
15216	20,0 x 20,0	7	1,5	
15217	24,0 x 24,0	9	3,5	

HALFTONE



Fingerfoodlöffel „HALFTONE“
party spoon
cuchara party
cuillère party



MAX
70°C



	Ø cm	↑ cm	Farbe / Colour	VE / unit
84158	5,5	7	■ ■	24



Fingerfoodlöffel „HALFTONE“
party spoon
cuchara party
cuillère party



MAX
70°C



	cm	↑ cm	Farbe / Colour	VE / unit
84128	14,5 x 4,5	4,5	■ ■	12



Tablett „HALFTONE“
tray
bandeja
plateau



MAX
70°C



	cm	↑ cm
84125	24,5 x 15,0	3



Schale „HALFTONE“

bowl
cuenco
bol



	Ø cm	↑ cm	ltr.	VE / unit
84217	8	4	0,1	12



Schale „HALFTONE“

bowl
cuenco
bol



	cm	↑ cm	ltr.
84130	11,5 x 7,0	4,0	0,05
84131	14,0 x 8,0	4,5	0,10
84133	17,5 x 13,5	6,5	0,35
84134	24,0 x 17,5	7,5	0,8



Schale „HALFTONE“

bowl
cuenco
bol



	Ø cm	↑ cm	ltr.
84135	16,5	7,5	0,65

PADELLA



Schale „PADELLA“

bowl
cazuelita
plat 2 anses „cocotte“



	Ø cm	↑ cm	ltr.	Griff / handle cm
85150	21	9	1,5	5 x 3,5
85151	28	9	3,0	5 x 3,5

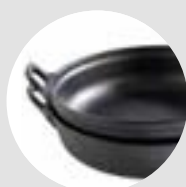

stapelbar und rutschfest
stackable and nonslip



PURE



Tablett „PURE“

tray
bandeja
plateau



	cm	↑ cm	GN	Farbe / Colour
83401	53,0 x 32,5	3	1/1	
83433	53,0 x 16,2	3	2/4	
83480	32,5 x 26,5	3	1/2	
83481	32,5 x 17,6	3	1/3	
83482	26,5 x 16,2	3	1/4	
83597	40,0 x 30,0	3	Bäcker-Maß	

	cm	↑ cm	GN	Farbe / Colour
83479	53,0 x 32,5	3	1/1	
83434	53,0 x 16,2	3	2/4	
83490	32,5 x 26,5	3	1/2	
83491	32,5 x 17,6	3	1/3	
83492	26,5 x 16,2	3	1/4	
83592	40,0 x 30,0	3	Bäcker-Maß	



Tablett „PURE“

tray
bandeja
plateau



	cm	↑ cm	Farbe / Colour
83403	35,5 x 18,0	3	
83417	30,0 x 21,0	3	
83402	53,0 x 18,0	3	



Tablett quadratisch „PURE“

tray square
bandeja cuadrada
plateau carré



	cm	↑ cm	Farbe / Colour
83418	18,0 x 18,0	3	
83407	21,0 x 21,0	3	
83406	26,5 x 26,5	3	
83405	37,0 x 37,0	3	



Tablett / Teller „PURE“

tray / plate
bandeja / plato
plateau / assiette



	Ø cm	↑ cm	Farbe / Colour
83884	31	2,5	White
83869	38	2,5	White



Teller, rund „CASUAL“

plate, round
plato, redondo
assiette, ronde



	Ø cm	↑ cm	Farbe / Colour
83500	22,5	2,5	White
83514	26,5	2,5	White



Schale „PURE“

bowl
cuenco
bol



	Ø cm	↑ cm	ltr.	Farbe / Colour
83450	5,5	4,0	0,02	White
83419	9,0	4,5	0,09	White
83453	13,0	6,5	0,30	White
83455	15,0	7,5	0,45	White
83415	20,0	10,5	1,25	White
	Ø cm	↑ cm	ltr.	Farbe / Colour
83451	5,5	4,0	0,02	Black
83452	9,0	4,5	0,09	Black
83454	13,0	6,5	0,30	Black



Schale „PURE“

bowl
cuenco
bol







	cm	↑ cm	ltr.	Farbe / Colour
84424	6,5 x 6,5	3,0	0,05	White
83414	9,0 x 9,0	4,0	0,14	White
83410	12,5 x 12,5	6,5	0,40	White
83409	19,0 x 19,0	9,0	1,50	White
83408	25,0 x 25,0	12,0	3,80	White
84425	32,0 x 32,0	14,0	8,0	White
	cm	↑ cm	ltr.	Farbe / Colour
84426	6,5 x 6,5	3,0	0,05	Black
83466	9,0 x 9,0	4,0	0,14	Black
83467	12,5 x 12,5	6,5	0,40	Black
83468	19,0 x 19,0	9,0	1,50	Black
83469	25,0 x 25,0	12,0	3,80	Black
84427	32,0 x 32,0	14,0	8,0	Black



Schale „PURE COLOR“

bowl
cuenco
bol



	cm	↑ cm	ltr.	Farbe / Colour
85260	19 x 19	9	1,5	 sand
85261	25 x 25	12	3,8	 sand
	cm	↑ cm	ltr.	Farbe / Colour
85266	19 x 19	9	1,5	 olive
85267	25 x 25	12	3,8	 olive



Schale „SLATE“

bowl
cuenco
bol



	cm	↑ cm	ltr.
84244	19 x 19	9	1,5
84245	25 x 25	12	3,8



Deckel „PURE“ mit Löffelaussparung
 cover with notched for spoons
 tapa con espacio para la cuchara
 couvercle avec encoche pour la louche



	cm	↑ cm	fits to
83600	19 x 19	1,5	84409, 84417, 84422, 83409, 83468, 83572, 83573
83601	25 x 25	1,5	84408, 84418, 84423, 84430, 83575, 83574, 83469, 83408



mit Deckel stapelbar
 stackable with cover



Schale „PURE“
 bowl
 cuenco
 bol



	cm	↑ cm	ltr.
83498	38,5 x 15,5	7,5	1,50
83499	51,0 x 15,5	7,5	2,40



GN Tablett „FRAMES“
 GN tray
 GN bandeja
 GN plateau



	cm	↑ cm	GN
84046	53,0 x 32,5	2	1/1
84047	32,5 x 26,5	2	1/2
84048	32,5 x 17,6	2	1/3



FLOAT



- Ideal für den Thekenbereich
- stapelbar mit Löffel und Deckel
- Schalenboden fixiert sich auf dem Deckel
- rutschfest (Antirutschfüßchen)

- ideal for the counter area
- stackable with spoon and lid
- the bottom of the bowl is fixed on the lid
- non-slip (with non-slip feet)

- ideal para la zona del mostrador
- apilable con cuchara y tapa
- el fondo del cuenco se fija en la tapa
- antideslizante (con pies antideslizantes)

- idéal pour l'aire de comptoir
- empilable avec cuillère et couvercle
- le fond du bol se fixe sur le couvercle
- antidérapant (avec pieds antidérapants)



Schale „FLOAT“ bowl cuenco bol



	Ø cm	↑ cm	ltr.	Farbe / Colour	VE / unit
83900	5,5	3,0	0,03		36
83902	9,0	4,5	0,15		
83904	13,0	6,5	0,45		
83906	15,0	7,5	0,70		
83908	20,5	10,0	1,90		
83901	5,5	3,0	0,03		36
83903	9,0	4,5	0,15		
83905	13,0	6,5	0,45		
83907	15,0	7,5	0,70		
83909	20,5	10,0	1,90		



Schale „FLOAT“

bowl
cuenco
bol



	cm	↑ cm	ltr.	Farbe / Colour	VE / unit
83910	5,5 x 5,5	3,0	0,03	White	36
83912	9,0 x 9,0	4,5	0,16	White	
83914	12,5 x 12,5	6,0	0,50	White	
83916	19,0 x 19,0	9,5	1,90	White	
83918	25,0 x 25,0	12,0	4,70	White	
83911	5,5 x 5,5	3,0	0,03	Black	36
83913	9,0 x 9,0	4,5	0,16	Black	
83915	12,5 x 12,5	6,0	0,50	Black	
83917	19,0 x 19,0	9,5	1,90	Black	
83919	25,0 x 25,0	12,0	4,70	Black	



stapelbar
stackable



GN Tablett „FLOAT“

GN tray
GN bandeja
GN plateau



	cm	↑ cm	GN	Farbe / Colour
83923	53,0 x 32,5	3	1/1	White
83925	32,5 x 26,5	3	1/2	White
83924	53,0 x 32,5	3	1/1	Black
83926	32,5 x 26,5	3	1/2	Black



Deckel „FLOAT“ mit Löffelaussparung

cover with notched for spoons
tapa con espacio para la cuchara
couverture avec encoche pour la louche



	cm	↑ cm	fits to
83921	19 x 19	1,3	83916, 83917
83922	25 x 25	1,3	83918, 83919

SINUS



GN Tablett „SINUS“

GN tray
GN bandeja
GN plateau



	cm	↑ cm	GN	Farbe / Colour
84230	53 x 32,5	2	1/1	—
84231	53 x 16,2	2	2/4	—



APART



GN Tablett „APART“

GN tray
GN bandeja
GN plateau



	cm	↑ cm	GN
83828	53,0 x 32,5	2,5	1/1
83830	32,5 x 26,5	2,5	1/2

CASCADE



Schale „CASCADE“

bowl
cuenco
bol



	cm	↑ cm	GN	litr.
83960	32,5 x 26,5	7,5	1/2	3,65
83962	26,5 x 16,2	7,5	1/4	1,50
83961	53 x 16,2	7,5	2/4	3,65



Außenmaße Gastronorm
size Gastronorm

GLOBAL BUFFET

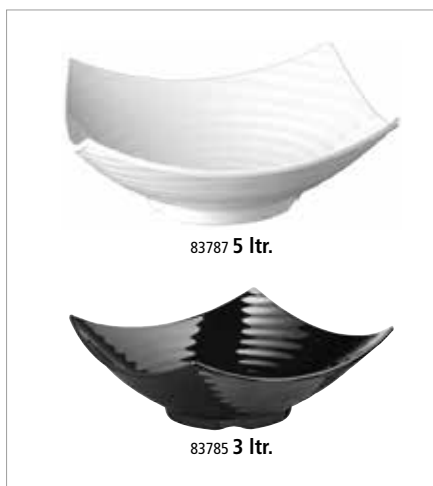

Schale „GLOBAL BUFFET“

bowl
cuenco
bol



	cm	↑ cm	ltr.	Farbe / Colour
83785	32,5 x 32,5	12,0	3,0	White
83787	40,0 x 40,0	13,5	5,0	White
84785	32,5 x 32,5	12,0	3,0	Black



Schale „GLOBAL BUFFET“

bowl
cuenco
bol



	cm	↑ cm	ltr.	Farbe / Colour
83799	25,5 x 25,5	13,0	3,0	White
83788	32,0 x 32,0	16,5	4,5	White
83789	35,0 x 35,0	17,0	6,0	White
83790	40,0 x 40,0	17,5	8,0	White



Schale „GLOBAL BUFFET“

bowl
cuenco
bol



	cm	↑ cm	ltr.	Farbe / Colour
84462	44 x 25	20	3,3	White



Schale „LEAF“

bowl
cuenco
bol



	cm	↑ cm	ltr.	Farbe / Colour
84200	42 x 19,5	6,5	1,0	White

CAKEPLATES



Servier- und Tortenplatte „CASUAL“

cake plate
porta pasteles
présentoir à gâteaux



	Ø cm	↑ cm
83890	31	8
83891	31	16



Servier- und Tortenplatte „CASUAL“

cake plate
porta pasteles
présentoir à gâteaux



	cm	↑ cm
83892	31 x 31	8
83893	31 x 31	16



Torten- / Konditorplatte

cake stand
soporte para pastel
présentoir à gâteaux



Rand fixiert die Haube, mit Antirutschfüßchen
carved edge fixes the cover, with non-slip feet
ranura para fijar bien la campana, con pies antideslizantes
bord rainuré pour maintenir ferme la cloche, avec pieds antidérapants

	Ø cm	↑ cm	Farbe / Colour
00468	31,0	3,5	White
00469	31,0	3,5	Black



Fass, 2-teilig

bowl
cuenco
bol



2-teilig: Unterteil / Edelstahlschale
2 pcs.: lower part / stainless steel bowl
set de 2: parte inferior / cuenco de acero inoxidable
set de 2: partie inférieure / bol en acier inox

	Ø cm	↑ cm
85250	26	16

Unterteil / lower part / parte inferior / partie inférieure

	Ø cm	↑ cm	ltr.
85251	25	16	4,5

Edelstahlschale / stainless steel bowl / cuenco de acero inoxidable / bol en acier inox

	Ø cm	↑ cm	ltr.
85252	26	9	3,0



Unterteil mit Eis füllen für perfekte Kühlung sensibler Speisen
fill the bottom part with ice for perfect cooling of sensitive dishes



Schale „BALANCE“

bowl
cuenco
bol



	Ø cm	↑ cm	ltr.	Farbe / Colour
84040	14,5	9,0	0,4	White
84041	21,0	13,0	1,5	White
84042	24,5	15,0	2,5	White
84043	30,0	19,5	5,0	White

	Ø cm	↑ cm	ltr.	Farbe / Colour
85040	14,5	9,0	0,4	Black
85041	21,0	13,0	1,5	Black
85042	24,5	15,0	2,5	Black
85043	30,0	19,5	5,0	Black

Buffetständer „KING“ / buffet stand / soporte para buffet / présentoir buffet

	Ø cm	↑ cm
03622	15	14
03623	15	21



Tablett / Teller

tray / plate
bandeja / plato
plateau / assiette



	Ø cm	↑ cm	Farbe / Colour
83869	38	2,5	White

Rolltophaube mit verchromtem Kugelgriff

rolltop cover with chrome plated handle
campana abatible con pomo cromado
cloche basculante avec bouton chromé



	Ø cm	↑ cm
18388	38	20



Frischhalte-Haube

cover
campana
cloche



	Ø cm	↑ cm
06510	30	11,5

mit verchromtem Griff / with chrom plated handle / con botón cromado / avec bouton chromé

	Ø cm	↑ cm
06512	30	11,5

CASUAL



Schälchen „CASUAL MINI“

bowl
cuenco
bol mini



	cm	↑ cm	ltr.	Farbe / Colour
83880	6,0	2,5	0,02	White
83881	7,5	3,5	0,05	White



Schale „CASUAL MAXI“

bowl
cuenco
bol



	Ø cm	↑ cm	ltr.	Farbe / Colour
83696	10	4,5	0,15	White
83698	12	5,5	0,25	White
83700	14	6,5	0,50	White
83704	20	9,2	1,80	White
83702	23	10,5	2,50	White
	Ø cm	↑ cm	ltr.	Farbe / Colour
83697	10	4,5	0,15	Black
83699	12	5,5	0,25	Black
83701	14	6,5	0,50	Black
83705	20	9,2	1,80	Black
83703	23	10,5	2,50	Black



Schale „CASUAL“

bowl
cuenco
bol



	cm	↑ cm	ltr.
84221	26,5 x 10,5	6,5	1,0



83605 Ø 8 cm

passend zu Schalen Ø 7,5 cm
fits to bowls Ø 7,5 cm



83606 Ø 14,5 cm

passend zu Schalen Ø 14 cm
fits to bowls Ø 14 cm



83607 Ø 20,5 cm

passend zu Schalen Ø 20 cm
fits to bowls Ø 20 cm

Deckel „CASUAL“, 5er Set

cover, 5 pcs.

tapa, set de 5

couvercle, set de 5



Hygienischer Schutz für Ihre Speisen

dichtschließend, schwappsicherer Transport

protection for your food

tightly closing, slosh-proof transport

protección de alimentos, con cierre hermético, transporte sin salpicaduras

protection des aliments

fermeture hermétique, transport sans éclaboussures

	Ø cm	↑ cm	fits to	pcs.
83605	8,0	0,5	11866, 83881, 15400, 15416, 15461, 15462, 15467, 40655, 40656	5
83606	14,5	0,5	11865, 83700, 83701, 85104, 85105, 85107	5
83607	20,5	0,5	83704, 83705, 15404, 15420	5



stapelbar
stackable



84215



84216

Schale „CASUAL“

bowl

cuenco

bol



	Ø cm	↑ cm	ltr.	Farbe / Colour
84215	10	6,5 / 8,5	0,2	—
84216	12	7,5 / 9,5	0,3	—



Schale „CASUAL“

bowl

cuenco

bol



	Ø cm	↑ cm	ltr.	Farbe / Colour
84295	10	7	0,13	—



Dipschale „CASUAL“

dip tray

bandeja para dips

plateau pour dips



	cm	↑ cm	Farbe / Colour
84220	29 x 9	3	—



83782



83798



83777

Dipschälchen „CASUAL“

dip bowl

cuenco para dip

ramequin



	Ø cm	↑ cm	ltr.	Farbe / Colour	VE / unit
83780	6,0	4,0	0,05	—	24
83781	7,5	4,0	0,07	—	24
83782	8,0	4,5	0,08	—	24
83783	8,5	4,5	0,12	—	24
83798	6,0	4,0	0,05	—	24
83777	6,0	3,5	0,04	—	24



Dipschälchen „FLOWER POT“

dip bowl
cuenco para dip
ramequin



	Ø cm	↑ cm	ltr.	Farbe / Colour	VE / unit
84470	6,0	3,5	0,04		60
84471	6,0	3,5	0,04		60
84472	6,0	3,5	0,04		60



Dipschälchen, 6er Set

dip bowl, 6 pcs.
cuenco para dip, set de 6
ramequin, set de 6



	Ø cm	↑ cm	ltr.	Farbe / Colour	pcs.
85240	6	4	0,04		6
85241	6	4	0,04		6
85242	6	4	0,04		6
85243	6	4	0,04		6
85244	6	4	0,04		6



Schale „MINI“

bowl
cuenco
bol



	cm	↑ cm	ltr.	Farbe / Colour	VE / unit
84750	8 x 8	3	0,06		24



Teller „MINI“

plate
plato
assiette



	cm	↑ cm	ltr.	VE / unit
84444	10,5 x 8,5	2,0	0,07	20



Schale „MINI“

bowl
cuenco
bol



	cm	↑ cm	ltr.	VE / unit
84445	10,5 x 6,0	4,0	0,07	20
84446	13,5 x 7,5	3,0	0,07	20
84448	9,5 x 9,0	5,5	0,09	20
84449	13,0 x 12,0	7,5	0,18	20



Schale „MINI“

bowl
cuenco
bol



	cm	↑ cm	ltr.	VE / unit
84452	11,5 x 7,5	3,0	0,06	24
84454	11,5 x 6,0	5,5	0,04	24
84456	8,5 x 7,0	6,0	0,07	24
84458	8,0 x 8,0	4,0	0,10	24
84450	7,5 x 7,0	4,5	0,05	24



Schale „MINI“
bowl
cuenco
bol



	Ø cm	↑ cm	ltr.	VE / unit	Farbe / Colour
84775	8,5	2,5	0,07	60	White
84778	8,5	2,5	0,07	60	Black
84781	8,5	2,5	0,07	60	Grey



Schale „MINI“
bowl
cuenco
bol



	Ø cm	↑ cm	ltr.	VE / unit	Farbe / Colour
84776	8,5	2,5	0,07	48	White
84779	8,5	2,5	0,07	48	Black
84782	8,5	2,5	0,07	48	Grey



Schale „MINI“
bowl
cuenco
bol



	cm	↑ cm	ltr.	VE / unit	Farbe / Colour
84777	9,5 x 5,5	5,5	0,07	48	White
84780	9,5 x 5,5	5,5	0,07	48	Black
84783	9,5 x 5,5	5,5	0,07	48	Grey



Schale „HALFTONE“
bowl
cuenco
bol



	Ø cm	↑ cm	ltr.	VE / unit
84217	8,0	4,0	0,1	12



Dipschälchen „GOURMET“
dip bowl
cuenco para dip
ramequin



	Ø cm	↑ cm	ltr.	VE / unit
84018	7	6	0,05	20

FLYING BUFFET



Fingerfood-Teller „FLYING BUFFET“

fingerfood plate
plato para el aperitivo
assiette pour apéritif



	cm	↑ cm	Farbe / Colour	VE / unit
83878	9,5 x 9,5	1,5 / 3,5		24
83879	9,5 x 9,5	1,5 / 3,5		24



Schale „FLOAT“

bowl
cuenco
bol



	cm	↑ cm	Farbe / Colour
83912	9 x 9	4,5	
83913	9 x 9	4,5	



GN Tablett „APART“

GN tray
GN bandeja
GN plateau



	cm	↑ cm	GN
83828	53 x 32,5	2,5	1/1
83830	32,5 x 26,5	2,5	1/2



GN Edelstahl Tablett
GN stainless steel platter
GN bandeja de acero inoxidable
GN plateau en acier inox



	cm	GN
11119	53 x 32,5	1/1

FINGERFOODLÖFFEL



Fingerfoodlöffel „HALFTONE“
party spoon
cuchara party
cuillère party



	∅ cm	↑ cm	VE / unit
84158	5,5	7	24



Fingerfoodlöffel „HALFTONE“
party spoon
cuchara party
cuillère party



	cm	↑ cm	VE / unit
84128	14,5 x 4,5	4,5	12



Fingerfoodlöffel „LEAF“
party spoon
cuchara party
cuillère party



	cm	↑ cm	Farbe / Colour	VE / unit
83889	10 x 4,5	1,5		50
83887	10 x 4,5	1,5		50
83888	10 x 4,5	1,5		50





Fingerfoodlöffel „HONG KONG“

party spoon
cuchara party
cuillère party



MAX
70°C



	cm	↑ cm	Farbe / Colour	VE / unit
83486	13 x 4,5	4,5		60
83487	13 x 4,5	4,5		60



Fingerfoodlöffel „MING HING“

party spoon
cuchara party
cuillère party



MAX
70°C



	cm	↑ cm	Farbe / Colour	VE / unit
83842	11 x 4,5	4		60
83843	11 x 4,5	4		60



Schale „MINI“

bowl
cuenco
bol



MAX
70°C



	cm	↑ cm	ltr.	VE / unit
84460	35 x 4,5	3	0,20	10



Schale, rund „TAO“

bowl, round
cuenco, redondo
bol, rond



MAX
70°C



	cm	↑ cm	ltr.	Farbe / Colour
83648	10,5 x 10,0	6,5 / 3,0	0,07	
83649	10,5 x 10,0	6,5 / 3,0	0,07	

CUTLERY REST



Besteckablage „SMALL WAVE“
cutlery rest
reposa cuchara
pose-cuillère



	cm	↑ cm
83897	26 x 13	4,5



Besteckablage „BOWL“
cutlery rest
reposa cuchara
pose-cuillère



	cm	↑ cm	ltr.
83803	22,5 x 11	6	0,5



Besteckablage „SPOON“
cutlery rest
reposa cuchara
pose-cuillère



	cm	↑ cm
83801	26 x 10,5	5



Servierlöffel „PROFI“
serving spoon
cuchara para servir
cuillère de service



	cm	→ cm	Farbe / Colour
84020	7 x 6,5	26,5	White
84021	7 x 6,5	26,5	Black



Salatlöffel
salad spoon
cuchara para ensalada
cuillère à salade



	cm	→ cm
84035	8 x 7	24



Eierbecher, 4er Set
egg holder, 4 pcs. set
huevera, set de 4
coquetier, set de 4



	Ø cm	↑ cm	pcs.	Farbe / Colour
83849 <small>NEW</small>	8,5	2	4	Black
83848	8,5	2	4	White



Eierbecher, 4er Set
egg holder, 4 pcs. set
huevera, set de 4
coquetier, set de 4



	Ø cm	↑ cm	pcs.
83851	8	3	4



GN-Behälter „ECOLINE“

GN container
GN cubeta
GN bac

mit Stapelnocke

with notching edge

con borde marcado para el apilado

avec rebord pour l'empilage



	GN	↓ mm	ltr.	cm	Farbe / Colour
83759	1/1	65	7,10	53,0 x 32,5	White
83755	2/4	65	3,00	53,0 x 16,2	White
83757	1/2	65	3,40	32,5 x 26,5	White
83753	1/3	65	2,00	32,5 x 17,6	White
83751	1/4	65	1,35	26,5 x 16,2	White
83749	1/6	65	0,80	17,6 x 16,2	White

	GN	↓ mm	ltr.	cm	Farbe / Colour
83758	1/1	65	7,10	53,0 x 32,5	Black
83754	2/4	65	3,00	53,0 x 16,2	Black
83756	1/2	65	3,40	32,5 x 26,5	Black
83752	1/3	65	2,00	32,5 x 17,6	Black
83750	1/4	65	1,35	26,5 x 16,2	Black
83748	1/6	65	0,80	17,6 x 16,2	Black

	GN	↓ mm	ltr.	cm	Farbe / Colour
84300	1/1	100	10,6	53,0 x 32,5	White
84302	2/4	100	4,3	53,0 x 16,2	White
84301	1/2	100	4,7	32,5 x 26,5	White
84303	1/3	100	2,7	32,5 x 17,6	White
84304	1/4	100	1,9	26,5 x 16,2	White
84305	1/6	100	1,0	17,6 x 16,2	White

	GN	↓ mm	ltr.	cm	Farbe / Colour
84306	1/1	100	10,6	53,0 x 32,5	Black
84308	2/4	100	4,3	53,0 x 16,2	Black
84307	1/2	100	4,7	32,5 x 26,5	Black
84309	1/3	100	2,7	32,5 x 17,6	Black
84310	1/4	100	1,9	26,5 x 16,2	Black
84311	1/6	100	1,0	17,6 x 16,2	Black



GN-Deckel

GN-lid

GN tapa

GN couvercle



	GN	cm
82001	1/1	53,0 x 32,5
82013	1/2	32,5 x 26,5
82019	1/3	32,5 x 17,6
82029	1/4	26,5 x 16,2
82037	1/6	17,6 x 16,2





Tableware & Table Presentation

TAKASHI	254
LEVANTE	256
SNACKHOLDERS	262
ENAMELWARE	266
CAST IRON	268
DIP BOWLS	270
PEBBLES	272
PARTY SPOONS	273
WECK	274
BOWLS WOOD	280
SERVING BOARDS WOOD	282
SERVING BOARDS NATURAL SLATE	288
MANGO	290
TRAYS	292
SEAFOOD	293
MENAGES	294
SALT- / PEPPER MILLS	302
TABLE CADDYS	311
BUTTER DISHES EGG HOLDERS	312
GRAVY BOATS	314
FONDUE CAVIAR COOLER	317
PLACEMATS	318
SUGAR DISPENSERS	329
TABLE LAMPS	336
DECORATION	342
MENU HOLDERS	343
CUTLERY BINS	350
WASTE BINS	354

NEW

TAKASHI



- Made in Japan
- handgefertigt
- schwere Qualität
- made in Japan
- handcrafted
- heavy quality
- fabricado en Japón
- artesanal
- alta calidad
- fabriqué au Japon
- artisanal
- haute qualité

NEW



Teller / Sushiboard „TAKASHI“

plate / sushiboard
plato para sushi
assiette sushi



Glas, transparent / glass, transparent / cristal, transparente / verre, transparent

	cm	↑ cm	VE / unit
40900	19 x 6,5	1,5	3

NEW



Teller / Sushiboard „TAKASHI“

plate / sushiboard
plato para sushi
assiette sushi



Glas, transparent / glass, transparent / cristal, transparente / verre, transparent

	cm	↑ cm	VE / unit
40902	26 x 13	1,5	3

NEW



Teller / Sushiboard „TAKASHI“

plate / sushiboard
plato para sushi
assiette sushi



Glas, transparent / glass, transparent / cristal, transparente / verre, transparent

	cm	↑ cm	VE / unit
40904	23 x 18	1,5	3

NEW



Teller / Sushiboard „TAKASHI“

plate / sushiboard
plato para sushi
assiette sushi



Glas, transparent / glass, transparent / cristal, transparente / verre, transparent

	cm	↑ cm	VE / unit
40906	29,5 x 15,5	1,5	1



- Made in Japan
- handgefertigt
- schwere Qualität
- made in Japan
- handcrafted
- heavy quality
- fabricado en Japón
- artesanal
- alta calidad
- fabriqué au Japon
- artisanal
- haute qualité



NEW

Teller / Sushiboard „TAKASHI“

plate / sushiboard
plato para sushi
assiette sushi



Glas, french grey / glass, french grey / cristal, french grey / verre, french grey

	cm	↑ cm	VE / unit
40901	19 x 6,5	1,5	3



NEW

Teller / Sushiboard „TAKASHI“

plate / sushiboard
plato para sushi
assiette sushi



Glas, french grey / glass, french grey / cristal, french grey / verre, french grey

	cm	↑ cm	VE / unit
40903	26 x 13	1,5	3



NEW

Teller / Sushiboard „TAKASHI“

plate / sushiboard
plato para sushi
assiette sushi



Glas, french grey / glass, french grey / cristal, french grey / verre, french grey

	cm	↑ cm	VE / unit
40905	23 x 18	1,5	3



NEW

Teller / Sushiboard „TAKASHI“

plate / sushiboard
plato para sushi
assiette sushi



Glas, french grey / glass, french grey / cristal, french grey / verre, french grey

	cm	↑ cm	VE / unit
40907	29,5 x 15,5	1,5	1

LEVANTE



Levante Küche passend serviert! Viel Gemüse, wenig Fleisch und eine Vielfalt an Gewürzen charakterisieren die Küche des Nahen Ostens. Der östliche Mittelmeerraum, also Syrien, Libanon, Jordanien, Israel und Palästina wird als Levante bezeichnet. Als Levante-Küche wird die Essenstradition dieser Länder als Food-Trend gefeiert.

Levantine cuisine served appropriately! Lots of vegetables, little meat and a variety of spices characterise the cuisine of the Middle East. The eastern Mediterranean region, i. e. Syria, Lebanon, Jordan, Israel and Palestine is referred to as the Levant. As Levantine cuisine, the food tradition of these countries is celebrated as a food trend.

Cocina levantina servida como es debido. Mucha verdura, poca carne y una gran variedad de especias caracterizan la cocina de Oriente Medio. La región del Mediterráneo oriental, es decir, Siria, Líbano, Jordania, Israel y Palestina, se denomina Levante. La cocina levantina, la tradición alimentaria de estos países, se celebra como una tendencia alimentaria.

Cuisine levantine servie comme il se doit! Beaucoup de légumes, peu de viande et une variété d'épices caractérisent la cuisine du Moyen-Orient. La région de la Méditerranée orientale, c'est-à-dire la Syrie, le Liban, la Jordanie, Israël et la Palestine, est appelée le Levant. La tradition alimentaire de ces pays, la cuisine levantine, est célébrée comme une tendance alimentaire.



Flaschenkühler „LEVANTE“

bottle cooler
enfriador de botella
rafraîchisseur de bouteille

doppelwandig für beste Isolierung, für 0,7 - 1,5 Liter-Flaschen

double wall cooler keeps the temperature for a long time, for 0,7 - 1,5 ltr. bottles

doble pared para mantener el frío largo tiempo, para botellas de 0,7 - 1,5 ltr.

double paroi pour une meilleure conservation de la température, pour bouteilles de 0,7 à 1,5 l.



	cm	↑ cm	Farbe / Colour
36125	12 / 10	20	
36127	12 / 10	20	



Tablett „LEVANTE“

tray
bandeja
GN plateau



	cm	↑ cm	ltr.	Farbe / Colour
40712	26,5 x 16	3	0,70	
40713	26,5 x 16	3	0,70	



Präsentationsmöglichkeit
presentation example



Schale „LEVANTE“

bowl
cuenco
bol



	Ø cm	↑ cm	ltr.	Farbe / Colour
40700	9,5	4,5	0,14	
40701	9,5	4,5	0,14	
40702	12	6,5	0,32	
40703	12	6,5	0,32	
40704	17	8,5	0,90	
40705	17	8,5	0,90	



stapelbar
stackable

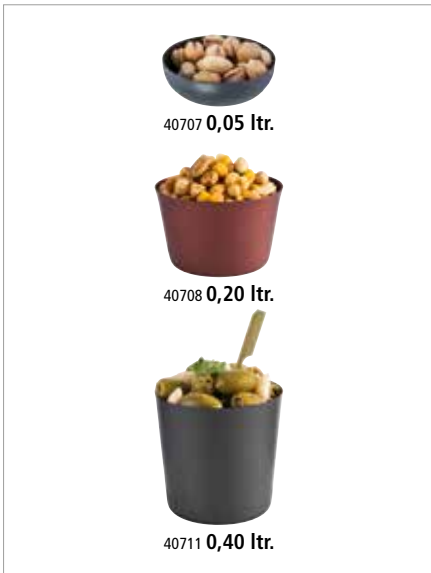

Schale „LEVANTE“

bowl
cuenco
bol



	Ø cm	↑ cm	ltr.	Farbe / Colour
40706	7,5	2,5	0,05	
40707	7,5	2,5	0,05	
40708	8,5	5,5	0,20	
40709	8,5	5,5	0,20	
40710	8,5	8,5	0,40	
40711	8,5	8,5	0,40	



Präsentationsmöglichkeit
presentation example



Dipschälchen, 6er Set „LEVANTE“

dip bowl, 6 pcs.
cuenco para dip, set de 6
ramequin, set de 6



	Ø cm	↑ cm	ltr.	Farbe / Colour	pcs.
40722	6,0	2,5	0,04		6
40723	6,0	2,5	0,04		6



Präsentationsmöglichkeit
presentation example



Dipschälchen, 6er Set „LEVANTE“

dip bowl, 6 pcs.
cuenco para dip, set de 6
ramequin, set de 6



	Ø cm	↑ cm	ltr.	Farbe / Colour	pcs.
40726	6,0	4,5	0,06		6
40727	6,0	4,5	0,06		6

NEW SNACKHOLDER

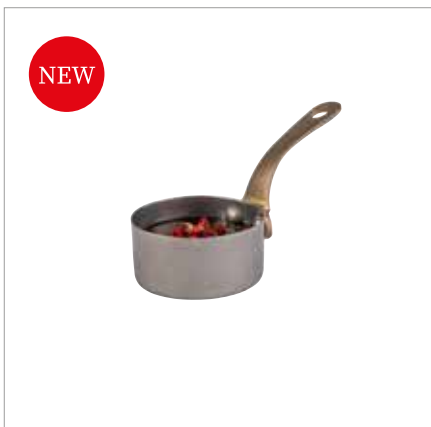

NEW

Stielkasserolle / Serviertopf
 saucepan / serving pot
 cacerola / olla
 casserole à manche / marmite
Antik-Edelstahl-Look
 antique stainless steel look
 acero inoxidable look antiguo
 look acier inox antique



	Ø cm	↑ cm	ltr.	Griff / handle cm
40780	5,5	2,5	0,05	5

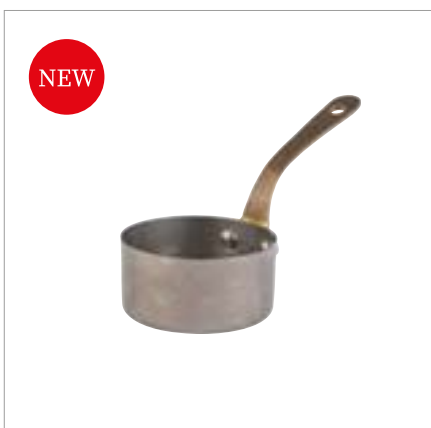

NEW

Stielkasserolle / Serviertopf
 saucepan / serving pot
 cacerola / olla
 casserole à manche / marmite
Antik-Edelstahl-Look
 antique stainless steel look
 acero inoxidable look antiguo
 look acier inox antique



	Ø cm	↑ cm	ltr.	Griff / handle cm
40781	7	3,5	0,12	7,5

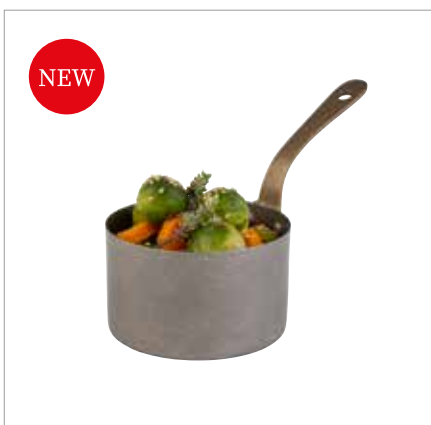

NEW

Stielkasserolle / Serviertopf
 saucepan / serving pot
 cacerola / olla
 casserole à manche / marmite
Antik-Edelstahl-Look
 antique stainless steel look
 acero inoxidable look antiguo
 look acier inox antique



	Ø cm	↑ cm	ltr.	Griff / handle cm
40782	9,5	5,5	0,3	7



NEW

Stielkasserolle / Serviertopf

saucepan / serving pot
cacerola / olla
casserole à manche / marmite

Antik-Edelstahl-Look

antique stainless steel look
acero inoxidable look antiguo
look acier inox antique



	Ø cm	↑ cm	ltr.	Griff / handle cm
40783	14	4	0,4	10

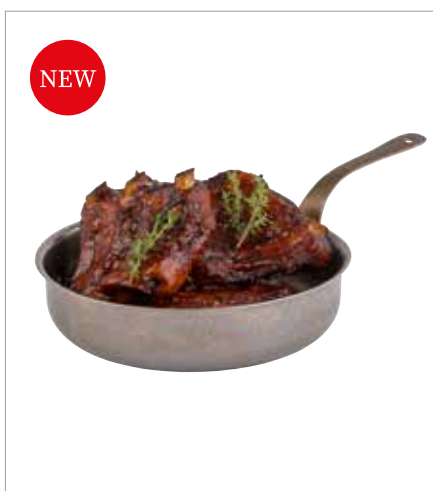

NEW

Stielkasserolle / Serviertopf

saucepan / serving pot
cacerola / olla
casserole à manche / marmite

Antik-Edelstahl-Look

antique stainless steel look
acero inoxidable look antiguo
look acier inox antique



	Ø cm	↑ cm	ltr.	Griff / handle cm
40784	18,5	4,5	0,9	10,5



NEW

Serviertopf

serving pot
olla
marmite

Antik-Edelstahl-Look

antique stainless steel look
acero inoxidable look antiguo
look acier inox antique



	Ø cm	↑ cm	ltr.	Griff / handle cm
40785	11,5	5	0,35	2

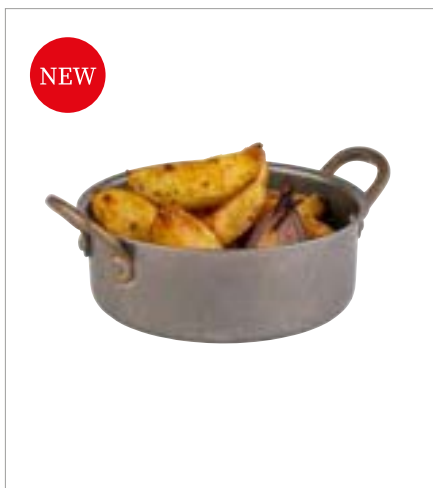

NEW

Serviertopf

serving pot
olla
marmite

Antik-Edelstahl-Look

antique stainless steel look
acero inoxidable look antiguo
look acier inox antique



	Ø cm	↑ cm	ltr.	Griff / handle cm
40786	14	5	0,55	2



MUMBAI



Serviertöpfchen „MUMBAI“

small serving pot
olla pequeña de servir
marmite petite de servir



Edelstahl, außen: Kupfer-Look, gehämmerte Oberfläche, Griffe vergoldet
stainless steel, outside: copper look, hammered surface, handles gold-plated
acero inoxidable, exterior: look cobre, superficie martillada, asas doradas
acier inox, extérieur: look cuivre, surface martelée, poignées dorées

	Ø cm	↑ cm	ltr.	Griff / handle cm
40730	9,0	5,5	0,30	2,25
40731	11,5	4,5	0,35	2,00
40732	11,5	7,0	0,60	2,25
40733	14,0	5,0	0,50	1,75
40734	16,0	5,0	0,70	1,75



Mini-Servierpfanne „MUMBAI“

small serving pan
olla pequeña de servir
marmite petite de servir



Edelstahl, außen: Kupfer-Look, gehämmerte Oberfläche, Griffe vergoldet
stainless steel, outside: copper look, hammered surface, handles gold-plated
acero inoxidable, exterior: look cobre, superficie martillada, asas doradas
acier inox, extérieur: look cuivre, surface martelée, poignées dorées

	cm	↑ cm	ltr.	Griff / handle cm
40735	12,5 x 8,5	4,0	0,25	2,0
40736	14,5 x 9,5	4,5	0,45	2,0



Schale „MUMBAI“

bowl
cuenco
bol



Edelstahl, außen: Kupfer-Look, gehämmerte Oberfläche, Griffe vergoldet
stainless steel, outside: copper look, hammered surface, handles gold-plated
acero inoxidable, exterior: look cobre, superficie martillada, asas doradas
acier inox, extérieur: look cuivre, surface martelée, poignées dorées

	Ø cm	↑ cm	ltr.
40737	8,5	4,5	0,15
40738	9,0	5,0	0,20



40740 0,6 ltr.



40741 0,3 ltr.



40742 0,5 ltr.

Serviertöpfchen
small serving pot
olla pequeña de servir
marmite petite de servir

Aluminium anthrazit, Griffe aus Messing
aluminium anthracite, brass handles
aluminio antracita, asas de latón
aluminium anthracite, poignées en laiton



	Ø cm	↑ cm	ltr.	Griff / handle cm
40740	11,5	9,5	0,6	2,5
40741	13,5	5,0	0,3	3,5
40742	15,0	6,0	0,5	2,5



Mini-Servierpfanne „SNACKHOLDER“
mini pan
sartén en formato mini
poêle à frire mini



	cm	↑ cm	ltr.
40660	14,5 x 9,5	4,5 / 6,5	0,5



40186 0,30 ltr.



40187 0,55 ltr.



40188 0,75 ltr.

Serviertöpfchen „MUMBAI“

small serving pot
olla pequeña de servir
marmite petite de servir

gehämmerte Oberfläche
hammered surface
superficie martillada
surface martelée



	Ø cm	↑ cm	ltr.	Griff / handle cm
40186	9,5	5,5	0,30	2,5
40187	13,5	5,0	0,55	3,0
40188	15,5	5,0	0,75	3,0



40642 0,05 ltr.



40643 0,12 ltr.



40644 0,32 ltr.

Stielkasserolle / Serviertopf

sauté pan / mini sauce pan
cazo recto bajo
plat à sauter

hochglanzpoliert
mirror polished
pulido brillante
poli brillant



	Ø cm	↑ cm	ltr.	Griff / handle cm
40642	5,5	2,5	0,05	6
40643	7,0	3,5	0,12	8,5
40644	9,5	5,5	0,32	8,5

SNACKHOLDER



Die Mini-Edelstahlkörbchen dienen dem portionsweisen Servieren. Zum originellen Servieren von Beilagen geeignet.

The mini frying baskets are used to present individual portions in an original way.

Las mini cestas para freír se utilizan para presentar las porciones individuales de forma original.

Les paniers à friture offrent une présentation originale pour servir apéritifs, snacks, tapas et autres rations individuelles.



Servier-Frittierkorb „SNACKHOLDER“

stainless steel fry baskets
cestitas inox para el servicio mesa
paniers inox pour le service sur table



	Ø cm	↑ cm	Griff / handle cm	Farbe / Colour	
40600	8	7,5	9,5		stainless steel
40602	8	7,5	9,5		copper
40624	8	7,5	9,5		black mat
40601	9	8,5	9,0		stainless steel
40603	9	8,5	9,0		copper
40625	9	8,5	9,0		black mat



Servier-Frittierkorb „SNACKHOLDER“

stainless steel fry baskets
cestitas inox para el servicio mesa
paniers inox pour le service sur table



	cm	↑ cm	Griff / handle cm	Farbe / Colour	
40610	21,5 x 10,5	4,5	9,5		stainless steel
40612	21,5 x 10,5	4,5	9,5		copper
40628	21,5 x 10,5	4,5	9,5		black mat
40611	26,0 x 13,0	5,0	9,0		stainless steel
40613	26,0 x 13,0	5,0	9,0		copper
40629	26,0 x 13,0	5,0	9,0		black mat



Servier-Frittierkorb „SNACKHOLDER“

stainless steel fry baskets
cestitas inox para el servicio mesa
paniers inox pour le service sur table



	cm	↑ cm	Griff / handle cm	Farbe / Colour	
40620	10,0 x 8,5	6,5	9,0		stainless steel
40622	10,0 x 8,5	6,5	9,0		copper
40626	10,0 x 8,5	6,5	9,0		black mat
40621	13,0 x 10,5	9,0	13,5		stainless steel
40623	13,0 x 10,5	9,0	13,5		copper
40627	13,0 x 10,5	9,0	13,5		black mat



Snackholder
serving cup
vaso para servir
gobelet à apéritif



	Ø cm	↑ cm	ltr.	Farbe / Colour
40606	8,5	8,5	0,35	stainless steel
40617	8,5	8,5	0,35	stainless copper
40607	8,5	8,5	0,35	hammered surface
40618	8,5	8,5	0,35	hammered surface
40605	9,5	8,5 / 11,5	0,45	stainless steel
40616	9,5	8,5 / 11,5	0,45	stainless copper

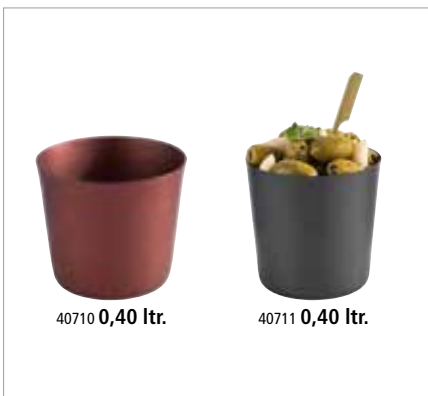

Schale „LEVANTE“
bowl
cuenco
bol



	Ø cm	↑ cm	ltr.	Farbe / Colour
40710	8,5	8,5	0,40	red
40711	8,5	8,5	0,40	dark grey



Servier- / Saucen-Eimer „SNACKHOLDER“

mini stainless steel bucket
cubo inox en formato mini
seau mini inox
hochglanzpoliert
mirror polished
pulido brillante
poli brillant



	Ø cm	↑ cm	ltr.	pcs.
40630	7	6,5	0,15	4
40631	9	8,5	0,33	1



Mini-Milchkanne „SNACKHOLDER“ 4er Set

mini milk can, 4 pcs.
lechera en formato mini, set de 4
pot à lait mini, set de 4



	Ø cm	↑ cm	ltr.	pcs.
40640	4,5	5	0,08	4

SNACKHOLDERS



40654 **0,12 ltr.**

40656 **0,35 ltr.**

40659 **0,80 ltr.**

40657 **1,30 ltr.**

40658 **1,80 ltr.**

Snackcan

serving can
lata para aperitivos
boîte de conserves pour apéritifs

matt poliert
matt polished
pulido mate
poli mat



	Ø cm	↑ cm	ltr.	
40654	6,5	4,0	0,12	ideale Beilagen Größe
40655	7,5	5,5	0,17	
40656	7,5	10,0	0,35	
40659	12,0	8,0	0,80	
40658	13,5	14,0	1,80	
40657	13,5	10,5	1,30	

Wachspapier „SNACKHOLDER“ / greaseproof paper squares
papel alimenticio para cucurucho / papier alimentaire pour cornet

	cm	pcs.	Motiv: Zeitung
40670	42 x 25	500	



Präsentationsmöglichkeit
presentation example



40685 **0,05 ltr.**

40686 **0,17 ltr.**

Schale

bowl
cuenco
bol
hochglanzpoliert
mirror polished
pulido brillante
poli brillant



	Ø cm	↑ cm	ltr.
40685	6	3,0	0,05
40686	8	4,5	0,17



0,15 ltr.

Schale "MUMBAI"

bowl
cuenco
bol
gehämmerte Oberfläche
hammered surface
superficie martillada
surface martelée



	Ø cm	↑ cm	ltr.
40185	9,5	3	0,15



40690 0,7 ltr.



40691 0,7 ltr.



40692 0,7 ltr.



40693 1,4 ltr.



40694 1,4 ltr.



40695 1,4 ltr.

Schale
bowl
cuenco
bol

gehämmerte Oberfläche
hammered surface
superficie martillada
surface martelée



	Ø cm	↑ cm	ltr.	Farbe / Colour	
40690	15,5 x 12,0	5,5	0,7		gold look
40691	15,5 x 12,0	5,5	0,7		copper look
40692	15,5 x 12,0	5,5	0,7		gunmetal-look
40693	23,0 x 15,5	6,0	1,4		gold look
40694	23,0 x 15,5	6,0	1,4		copper look
40695	23,0 x 15,5	6,0	1,4		gunmetal-look



Präsentationsmöglichkeit
presentation example



40604

Servierkorb „BURGER & FRIES“

serving basket
cesta para servir
corbeille de service

Servierkorb aus Metall mit 2 Haltern für Dipschälchen

metal serving basket with 2 holders for dip bowls

cesta de metal para servir con 2 soportes para cuencos para dip

corbeille de service en métal avec 2 supports pour ramequins



	cm	↑ cm
40604	39,5 x 20	11

passende Schälchen / suitable bowls / cuencos adecuados / bols
appropriés



	Ø cm	↑ cm	ltr.	VE / unit
83781	7,5	4	0,07	24



83781

83781

Servierbeispiel - Lieferung ohne Schälchen
delivery without bowls



Präsentationsmöglichkeit
presentation example

ENAMELWARE



Henkelbecher „ENAMELWARE“
beaker
vaso coctelero
bol mélangeur



	Ø cm	↑ cm	ltr.	Farbe / Colour
40636	7	5	0,10	
40632	9	8	0,35	
40637	10	9	0,50	



Schale „ENAMELWARE“
bowl
cuenco
bol



	Ø cm	↑ cm	ltr.	Farbe / Colour
40645	7,0	4,5	0,08	
40646	8,0	3,5	0,08	
40638	13,0	6,0	0,50	
40647	16,5	4,5	0,45	



Teller, flach „ENAMELWARE“

plate, flat
plato, plano
assiette, plat



	Ø cm	↑ cm	Farbe / Colour
40664	20	2	
40665	24	2	
40666	26	2	



Teller, tief „ENAMELWARE“

plate, deep
plato, profunda
assiette, profonde



	Ø cm	↑ cm	ltr.	Farbe / Colour
40661	18	3,5	0,35	
40662	22	3,5	0,60	
40663	24	3,5	0,85	



Schale „ENAMELWARE“

bowl
cuenco
bol



	cm	↑ cm	ltr.	Farbe / Colour
40667	16 x 12,0	3,5	0,20	
40668	18 x 13,5	4,0	0,35	



Schale „ENAMELWARE“

bowl
cuenco
bol



	cm	↑ cm	ltr.	Farbe / Colour
40669	28 x 23	4,5	1,9	





CAST IRON

Die Servierpfännchen aus emailiertem Gusseisen dienen dem portionsweisen Servieren und halten die Speisen warm.

The serving pans made of enameled cast iron are used for serving in portions and for keeping the food warm.

Las fuentes de hierro fundido esmaltado se utilizan para servir en porciones y mantener la comida caliente.

Les plateaux de service en fonte émaillée sont utilisés pour servir en portions et garder les aliments au chaud.



Servierpfännchen „CAST IRON“

serving pan
fuente para servir
plat de service

Gusseisen emailiert
enameled cast iron
hierro fundido esmaltado
fonte émaillée



	∅ cm	↑ cm	Farbe / Colour
88220	10	2	
88225	10	2	
88221	13	2	
88226	13	2	



Servierpfännchen „CAST IRON“

serving pan
fuente para servir
plat de service

Gusseisen emailiert
enameled cast iron
hierro fundido esmaltado
fonte émaillée



	cm	↑ cm	Farbe / Colour
88222	13 x 13	2	
88227	13 x 13	2	
88223	16 x 13	2	
88228	16 x 13	2	
88224	20 x 13	2	
88229	20 x 13	2	



SERVING TROWELS



Servierkelle „BOB“

serving trowel
paleta para servir
truelle de service



Edelstahl Servierkelle mit schwarzem Holzgriff

stainless steel serving trowel with black wooden handle
paleta para servir de acero inoxidable con mango de madera negra
truelle de service en acier inox avec manche en bois noir

	cm	↑ cm	Griff / handle cm	
40680	23,5 x 15,5	12,5	13,5	stainless steel
40681	23,5 x 15,5	12,5	13,5	■

Snackbox „INDUSTRIAL“

snack box
caja tentempié
casse-croûte

Metall, schwarz

metal, black
metal, negro
métal, noir



	cm	↑ cm	ltr.
40676	23,0 x 15,5	13,0	2,4



stapelbar
stackable

DIP BOWLS



Ob Nachos mit Käsedip, Gemüsesticks mit Joghurtsoße oder eine Käseplatte mit Feigensenf: All diese Köstlichkeiten finden in Dipschalen ihren Platz und regen den Appetit Ihrer Gäste an.

Whether nachos with cheese dip, vegetable sticks with yoghurt sauce or cheese platter with fig mustard: all these delicacies find their place in dip bowls and stimulate the appetite of your guests.

Ya sean nachos con dip de queso, palitos de verdura con salsa de yogur o tabla de quesos con mostaza de higos: todas estas delicias encuentran su lugar en los cuencos para dip y estimulan el apetito de sus invitados.

Qu'il s'agisse de nachos avec trempette au fromage, de bâtonnets de légumes avec sauce au yaourt ou d'un plateau de fromage avec moutarde aux figues : tous ces délices trouvent leur place dans les bols à trempette et stimulent l'appétit de vos invités.

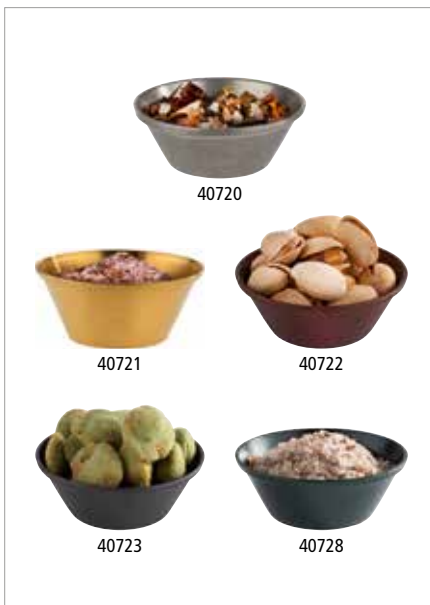

Dipschälchen, 6er Set

dip bowl, 6 pcs.
cuenco para dip, set de 6
ramequin, set de 6



	Ø cm	↑ cm	ltr.	Farbe / Colour	pcs.
40720	6,0	2,5	0,04		6
40721	6,0	2,5	0,04		6
40722	6,0	2,5	0,04		6
40723	6,0	2,5	0,04		6
40728	6,0	2,5	0,04		6



Präsentationsmöglichkeit
presentation example



Dipschälchen, 6er Set

dip bowl, 6 pcs.
cuenco para dip, set de 6
ramequin, set de 6



	Ø cm	↑ cm	ltr.	Farbe / Colour	pcs.
40724	6,0	4,5	0,06		6
40725	6,0	4,5	0,06		6
40726	6,0	4,5	0,06		6
40727	6,0	4,5	0,06		6
40729	6,0	4,5	0,06		6



Dipschälchen, 12er Set

dip bowl, 12 pcs.
cuenco para dip, set de 12
ramequin, set de 12



	Ø cm	↑ cm	ltr.	Farbe / Colour	pcs.
40760	6,0	3,5	0,04	—	12
40761	6,0	3,5	0,04	—	12
40762	6,0	3,5	0,04	—	12
40763	7,0	3,5	0,07	—	12
40764	7,0	3,5	0,07	—	12
40765	7,0	3,5	0,07	—	12
40766	7,5	4,0	0,09	—	12
40767	7,5	4,0	0,09	—	12
40768	7,5	4,0	0,09	—	12



Dipschälchen, 6er Set

dip bowl, 6 pcs.
cuenco para dip, set de 6
ramequin, set de 6



	Ø cm	↑ cm	ltr.	Farbe / Colour	pcs.
85240	6,0	4,0	0,04	—	6
85241	6,0	4,0	0,04	—	6
85242	6,0	4,0	0,04	—	6
85243	6,0	4,0	0,04	—	6
85244	6,0	4,0	0,04	—	6



Dipschälchen „FLOWER POT“

dip bowl
cuenco para dip
ramequin



	Ø cm	↑ cm	ltr.	Farbe / Colour	VE / unit
84470	6,0	3,5	0,04	—	60
84471	6,0	3,5	0,04	—	60
84472	6,0	3,5	0,04	—	60



Dipschälchen „CASUAL“

dip bowl
cuenco para dip
ramequin

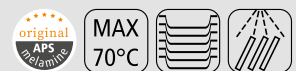

	Ø cm	↑ cm	ltr.	Farbe / Colour	VE / unit
83780	6,0	4,0	0,04	—	24
83781	7,5	4,0	0,07	—	24
83782	8,0	4,5	0,08	—	24
83783	8,5	4,5	0,12	—	24
83798	6,0	4,0	0,04	—	24
83777	6,0	3,5	0,03	—	24



Dipschälchen „GOURMET“

dip bowl
cuenco para dip
ramequin

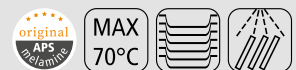

	Ø cm	↑ cm	ltr.	Farbe / Colour	VE / unit
84018	7,0	6,0	0,05	—	20



NEW PEBBLES



Schale, 4er Set „PEBBLES“

bowl, 4 pcs.
cuenco, set de 4
bol, set de 4



	cm	↑ cm	Farbe / Colour	pcs.
40790	6,5 x 6	2,5	copper look	4
40791	6,5 x 6	2,5	gunmetal look	4



PVD-beschichteter Edelstahl
PVD coated stainless steel

stapelbar
stackable



Teller, 4er Set „PEBBLES“

plate, 4 pcs.
plato, set de 4
assiette, set de 4



	cm	↑ cm	Farbe / Colour	pcs.
40792	8,5 x 8	1	copper look	4
40793	8,5 x 8	1	gunmetal look	4



PVD-beschichteter Edelstahl
PVD coated stainless steel

stapelbar
stackable



Teller, 4er Set „PEBBLES“

plate, 4 pcs.
plato, set de 4
assiette, set de 4



	cm	↑ cm	Farbe / Colour	pcs.
40794	9 x 9	1	copper look	4
40795	9 x 9	1	gunmetal look	4



PVD-beschichteter Edelstahl
PVD coated stainless steel

stapelbar
stackable

**Gourmetlöffel/-gabel, 6er Set**

tapas spoon / fork, 6 pcs.
cuchara / tenedor de tapas, set de 6
cuillère / fourchette à tapas, set de 6

Verwendung als Löffel oder Gabel möglich

can be used as a spoon or fork
puede utilizarse como cuchara o tenedor
peut être utilisé comme une cuillère ou une fourchette



	→ cm	pcs.
00699	10	6

**Gourmetlöffel „CLASSIC“**

party spoon
cuchara gourmet
cuillère gourmet

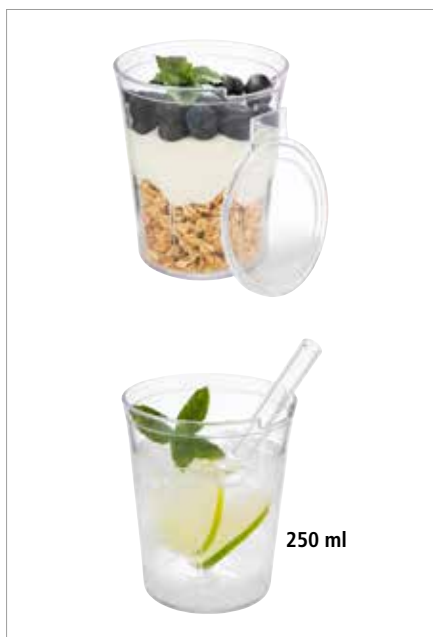

	→ cm		
00693	12,0	gunmetal look	PVD coated stainless steel
00677	13,5	stainless steel look	
00691	12,0	gold look	PVD coated stainless steel
00692	12,0	copper look	PVD coated stainless steel

**Becher Set „SUPER CUP“, 8er Set**

barrel mug set, 8 pcs.
vasos, set de 8
gobelets, set de 8

Set bestehend aus 8 Bechern + 8 Deckeln

set consists of 8 barrel mugs + 8 lids
set compuesto por 8 vasos + 8 tapas
set composé de 8 gobelets + 8 couvercles



**IDEAL
FÜR
„TAKE AWAY“**

	Ø cm	↑ cm	ltr.	pcs.
10506	8	10	0,25	8



mit Stapelnocke
with stacking cam

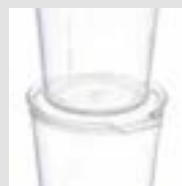

rutschfester Deckel
non-slip lid

**Snackspender**

snack dispenser
dispensador de snacks
distributeur de snacks

Behälter aus Glas, Schraubdeckel aus Edelstahl, Öffnung oval 3,5 x 2,5 cm

glass container, stainless steel screw cap, opening oval 3,5 x 2,5 cm
recipiente de cristal, tapón de rosca de acero inoxidable, apertura ovalada 3,5 x 2,5 cm
récipient en verre, couvercle à visser en acier inox, ouverture ovale 3,5 x 2,5 cm



	Ø cm	↑ cm	ltr.	Farbe / Colour
40516	8,5	15,5	0,35	
40517	8,5	15,5	0,35	

Original WECK



Weck-Flaschen, 6er Set

Weck-bottles, 6 pcs.
Weck-botellas, set de 6
Weck-bouteilles, set de 6



6 Flaschen + 6 Deckel, ideal zum Servieren von Saft, Smoothie, Dressing und Saucen

6 bottles + 6 covers, ideal for serving juice, smoothie, dressing and sauces

6 botellas + 6 tapas, ideal para servir zumo, licuado, aliño y salsas

6 bouteilles + 6 couvercles, idéal pour servir de jus, smoothie, vinaigrette et sauces

	Ø cm	↑ cm	ltr.	pcs
82307	6	14,5	0,25	6



Weck-Flaschen, 6er Set

Weck-bottles, 6 pcs.
Weck-botellas, set de 6
Weck-bouteilles, set de 6



6 Flaschen + 6 Deckel, ideal zum Servieren von Saft, Smoothie, Dressing und Saucen

6 bottles + 6 covers, ideal for serving juice, smoothie, dressing and sauces

6 botellas + 6 tapas, ideal para servir zumo, licuado, aliño y salsas

6 bouteilles + 6 couvercles, idéal pour servir de jus, smoothie, vinaigrette et sauces

	Ø cm	↑ cm	ltr.	pcs
82308	6	19	0,5	6



Weck-Flaschen, 6er Set

Weck-bottles, 6 pcs.
Weck-botellas, set de 6
Weck-bouteilles, set de 6



6 Flaschen + 6 Deckel, ideal zum Servieren von Saft, Smoothie, Dressing und Saucen

6 bottles + 6 covers, ideal for serving juice, smoothie, dressing and sauces

6 botellas + 6 tapas, ideal para servir zumo, licuado, aliño y salsas

6 bouteilles + 6 couvercles, idéal pour servir de jus, smoothie, vinaigrette et sauces

	Ø cm	↑ cm	ltr.	pcs
82309	6	25,5	1,0	6



Edelstahldeckel für Weck-Gläser

stainless steel lid for Weck-glasses
tapas de acero inoxidable por Weck tarros
couvercles en acier inox pour Weck verrines



	Ø cm	↑ cm	
82360	10,5	2	82346, 82347



82241 370 ml



82242 580 ml

Weck-Gläser mit Deckel, 2er Set

Weck-glasses with lid, 2 pcs.
Weck tarros de vidrio con tapa, set de 2
Weck verrines avec couvercle, set de 2

2 Gläser + 2 klappbare Edelstahldeckel

2 glasses + 2 foldable stainless steel lids

2 tarros + 2 tapas plegables de acero inoxidable

2 verrines + 2 couvercles pliables en acier inox

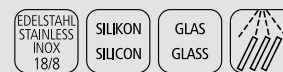

	Ø cm	↑ cm	ltr.	pcs
82241	11	7,5	0,37	2
82242	11	11	0,58	2



klappbarer Edelstahldeckel für Weck-Gläser

foldable stainless steel lid for Weck-glasses
tapa plegable de acero inoxidable por Weck tarros
couvercle pliable en acier inox pour Weck verrines



	Ø cm	↑ cm	
82361	10,5	4,5	82241, 82242, 82346, 82347



Holzdeckel für Weck-Gläser

wooden lid for Weck-glasses
tapas de madera por Weck tarros
couvercles en bois pour Weck verrines



	Ø cm	↑ cm	fits to
82362	11	2	82346, 82347



Holzdeckel für Weck-Gläser, 12er Set

wooden lid for Weck-glasses, 12 pcs.
tapas de madera para Weck tarros, set de 12
couvercles en bois pour Weck verrines, set de 12



	Ø cm	↑ cm	fits to	pcs.
82363	7	1,5	82307, 82308, 82309, 82310, 82312, 82314, 82316, 82370, 82371	12



Weck-Gläser mit Deckel, 12er Set

Weck-glasses with lid, 12 pcs.
 Weck tarros de vidrio con tapa, set de 12
 Weck verrines avec couvercle, set de 12



12 Gläser + 12 Deckel

12 glasses + 12 covers
 12 vasos + 12 tapas
 12 verrines + 12 couvercles

	Ø cm	↑ cm	ltr.	pcs
82310	6	5,5	0,08	12
82312	6	7,0	0,14	12
82314	6	8,0	0,16	12
82345	9	6	0,20	12

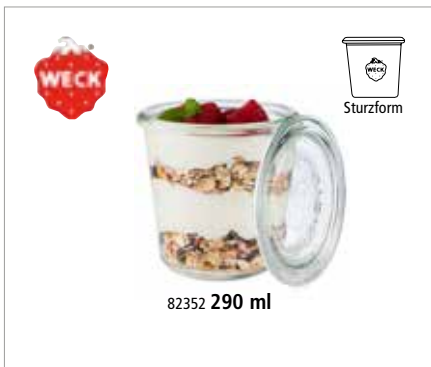

Weck-Gläser mit Deckel, 6er Set

Weck-glasses with lid, 6 pcs.
 Weck tarros de vidrio con tapa, set de 6
 Weck verrines avec couvercle, set de 6



6 Gläser + 6 Deckel

6 glasses + 6 covers
 6 tarros + 6 tapas
 6 verrines + 6 couvercles

	Ø cm	↑ cm	ltr.	pcs
82352	9	9	0,29	6



Weck-Gläser mit Deckel, 3er Set

Weck-glasses with lid, 3 pcs.
 Weck tarros de vidrio con tapa, set de 3
 Weck verrines avec couvercle, set de 3



3 Gläser + 3 Deckel

3 glasses + 3 covers
 3 vasos + 3 tapas
 3 verrines + 3 couvercles

	Ø cm	↑ cm	ltr.	pcs
82346	11	7,5	0,37	3



Weck-Gläser mit Deckel, 2er Set

Weck-glasses with lid, 2 pcs.
 Weck tarros de vidrio con tapa, set de 2
 Weck verrines avec couvercle, set de 2



2 Gläser + 2 Deckel

2 glasses + 2 covers
 2 vasos + 2 tapas
 2 verrines + 2 couvercles

	Ø cm	↑ cm	ltr.	pcs
82347	11	11	0,58	2



Weck-Gläser mit Deckel, 12er Set

Weck-glasses with lid, 12 pcs.
Weck tarros de vidrio con tapa, set de 12
Weck verrines avec couvercle, set de 12



12 Gläser + 12 Deckel
12 glasses + 12 covers
12 vasos + 12 tapas
12 verrines + 12 couvercles

	Ø cm	↑ cm	ltr.	pcs
82350	5,5	6	0,075	12
82316	7	8,0	0,22	12



Weck-Gläser mit Deckel, 6er Set

Weck-glasses with lid, 6 pcs.
Weck tarros de vidrio con tapa, set de 6
Weck verrines avec couvercle, set de 6



6 Gläser + 6 Deckel
6 glasses + 6 covers
6 tarros + 6 tapas
6 verrines + 6 couvercles

	Ø cm	↑ cm	ltr.	pcs
82354	11	9	0,58	6



Gourmetgläser, 12er Set

gourmet glasses, 12 pcs.
tarros gourmet, set de 12
verres gourmet, set de 12



	Ø cm	↑ cm	ltr.	pcs
82359	5	3,5	0,035	12
82370	6	5,5	0,08	12
82371	6	8,0	0,16	12



12er Set, ohne Deckel
12 pcs., without covers



Serviergestell „WECK“

serving stand
expositor
présentoir
ohne Gläser
without glasses
sin vasos
sans verrines



	Ø cm	↑ cm	
33246	22	59	12 x Ø 6 cm

passende Gläser / matching glasses / vasos a juego / verrines approprié



	Ø cm	↑ cm	ltr.	pcs
82310	6	5,5	0,08	12
82312	6	7,0	0,14	12
82314	6	8,0	0,16	12



Weck-Frischhaltedeckel, 5er Set

airtight cover, 5 pcs.
tapa hermética, set de 5
couvercle hermétique, set de 5
für Rundrandgläser Ø 6 cm, 5er Set
for Ø 6 cm glasses, 5 pcs. set
para vasos Ø 6 cm, set de 5
pour verrines Ø 6 cm, set de 5



	Ø cm	pcs.
82338	7	5



Gummidichtringe, 10er Set

rubber washer, 10 pcs.
juntas de goma, set de 10
joints de caoutchouc, set de 10
für Deckel der Weck-Gläser, im Beutel verpackt

for covers of Weck-glasses, packed in a bag
para las tapas de los tarritos Weck, empaquetado en una bolsa
pour la fermeture des verrines Weck, emballé dans un sac



	fits to	pcs.
82318	82307, 82308, 82309, 82310, 82312, 82314, 82316	10
82394	82345	10
82395	82346, 82347	10



8er Set Deckel-Klammer für 4 Weck-Gläser

8 pcs. cover clamps for 4 Weck-glasses
8 abrazaderas para 4 vasitos Weck
8 agrafes pour 4 verrines Weck



	pcs.
82319	8

NEW TWINZ



NEW



Gläser, 2er Set „TWINZ“

glasses, 2 pcs. set
vasos, set de 2
verres, set de 2

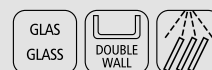

doppelwandig, ideal für kleine Speisen und Desserts oder Espresso
glass, double-walled, ideal for small dishes and desserts or espresso
vidrio, doble pared, ideal para platos pequeños y postres o espresso
verre, à double paroi, idéal pour les petits plats et les desserts ou espresso

	Ø cm	↑ cm	ltr.	pcs.
10370	6	6,5	0,08	2

NEW



Gläser, 2er Set „TWINZ“

glasses, 2 pcs. set
vasos, set de 2
verres, set de 2

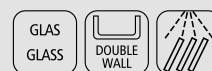

doppelwandig, ideal für kleine Speisen und Desserts oder Kaffee
glass, double-walled, ideal for small dishes and desserts or coffee
vidrio, doble pared, ideal para platos pequeños y postres o café
verre, à double paroi, idéal pour les petits plats et les desserts ou le café

	Ø cm	↑ cm	ltr.	pcs.
10371	8,5	8,5	0,23	2

NEW



Gläser, 2er Set „TWINZ“

glasses, 2 pcs. set
vasos, set de 2
verres, set de 2

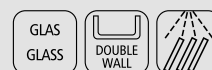

doppelwandig, ideal für kleine Speisen und Desserts oder Latte Macchiato
glass, double-walled, ideal for small dishes and desserts or latte macchiato
vidrio, doble pared, ideal para platos pequeños y postres o latte macchiato
verre, à double paroi, idéal pour les petits plats et les desserts ou le latte macchiato

	Ø cm	↑ cm	ltr.	pcs.
10372	8,5	14	0,38	2



Schale, 4er Set „OLIVE“

bowl, 4 pcs.
cuenco, set de 4
bol, set de 4



aus geöltem Olivenholz, naturbedingte Abweichung in Form, Maserung und Größe

oiled olive wood, natural deviation in shape, grain and size

de madera de olivo aceitada, diferencias naturales posibles en forma, grano y tamaño
en bois d'olivier huilé, éventuelles différences naturelles de forme, de grain et de taille

	∅ cm	↑ cm	ltr.	pcs.
01024	6	2	0,03	4



Schale, 2er Set „OLIVE“

bowl, 2 pcs.
cuenco, set de 2
bol, set de 2



aus geöltem Olivenholz, naturbedingte Abweichung in Form, Maserung und Größe

oiled olive wood, natural deviation in shape, grain and size

de madera de olivo aceitada, diferencias naturales posibles en forma, grano y tamaño
en bois d'olivier huilé, éventuelles différences naturelles de forme, de grain et de taille

	cm	↑ cm	ltr.	pcs.
01025	12,5 x 8	2,5	0,05	2



01010 0,15 ltr.

01011 0,25 ltr.

01012 0,50 ltr.

Schale „OLIVE“

bowl
cuenco
bol



aus geöltem Olivenholz, naturbedingte Abweichung in Form, Maserung und Größe

oiled olive wood, natural deviation in shape, grain and size

de madera de olivo aceitada, diferencias naturales posibles en forma, grano y tamaño
en bois d'olivier huilé, éventuelles différences naturelles de forme, de grain et de taille

	∅ cm	↑ cm	ltr.
01010	10,0	4,0	0,15
01011	12,5	4,5	0,25
01012	15,0	6,0	0,50



3 Größen ineinander
3 sizes in each other



00843 0,05 ltr.

00844 0,10 ltr.

Schale „OLIVE“

bowl
cuenco
bol



aus geöltem Olivenholz, naturbedingte Abweichung in Form, Maserung und Größe

oiled olive wood, natural deviation in shape, grain and size

de madera de olivo aceitada, diferencias naturales posibles en forma, grano y tamaño
en bois d'olivier huilé, éventuelles différences naturelles de forme, de grain et de taille

	cm	↑ cm	ltr.
00843	12,0 x 7,5	2,5	0,05
00844	16,5 x 9,5	2,5	0,10



Schale „OLIVE“

bowl
cuenco
bol

aus geöltem Olivenholz
oiled olive wood
de madera de olivo aceitada
en bois d'olivier huilé



	cm	↑ cm	ltr.
00907	13 x 8	6,5	0,2
00908	16 x 9	7,0	0,3
01023	25 x 8,5	7,5	0,4



Schale „OLIVE“

bowl
cuenco
bol

aus geöltem Olivenholz, naturbedingte Abweichung in Form, Maserung und Größe
oiled olive wood, natural deviation in shape, grain and size
de madera de olivo aceitada, diferencias naturales posibles en forma, grano y tamaño
en bois d'olivier huilé, éventuelles différences naturelles de forme, de grain et de taille



	cm	↑ cm	ltr.
01013	7,5 x 7,5	2,5	0,05
01014	17,5 x 8,5	2,5	0,15
01015	26,5 x 11,5	5,0	0,60



Servierbrett „OLIVE“

serving board
tabla de servir
planche de service

aus geöltem Olivenholz, naturbedingte Abweichung in Form, Maserung und Größe
oiled olive wood, natural deviation in shape, grain and size
de madera de olivo aceitada, diferencias naturales posibles en forma, grano y tamaño
en bois d'olivier huilé, éventuelles différences naturelles de forme, de grain et de taille



	cm	↑ cm
01022	39,5 x 21	2,5
01021	35,5 x 18,5	2,0



mit Safrille
with juice groove



Servierbrett „OLIVE“

serving board
tabla de servir
planche de service

aus geöltem Olivenholz, naturbedingte Abweichung in Form, Maserung und Größe
oiled olive wood, natural deviation in shape, grain and size
de madera de olivo aceitada, diferencias naturales posibles en forma, grano y tamaño
en bois d'olivier huilé, éventuelles différences naturelles de forme, de grain et de taille



	cm	↑ cm
00905	25,5 x 16,5	1,5
00906	35,0 x 20,5	1,5



Servierbrett „OLIVE“

servicing board
tabla de servir
planche de service



aus geöltem Olivenholz, mit 19 mm Aufhäng Bohrung, naturbedingte Abweichung in Form, Maserung und Größe

oiled olive wood, natural deviation in shape, grain and size
de madera de olivo aceitada, diferencias naturales posibles en forma, grano y tamaño

en bois d'olivier huilé, éventuelles différences naturelles de forme, de grain et de taille

	cm	↑ cm	Griff / handle cm
00870	25,0 x 17,0	1,5	-
00871	30,0 x 20,5	2,0	-
00875	19,0 x 12,5	1,5	6
00876	25,0 x 16,0	1,5	8
00877	31,0 x 20,0	1,5	9
00873	40,0 x 15,0	1,5	11
00874	44,0 x 20,0	2,0	12



SNACKBOX „OLIVE“

snackbox
caja tentempié
casse-croûte



aus geöltem Olivenholz

oiled olive wood

de madera de olivo aceitada

en bois d'olivier huilé

	cm	↑ cm
01016	22 x 15	6
01017	25 x 18	6



Tablett

tray
bandeja
plateau



aus Bambus, geeignet zum Servieren und Transportieren

made of bamboo, suitable for serving and transport

de bambú, para servir y transportar

en bambou, pour servir et transporter

	cm	↑ cm	GN
00845	32,5 x 26,5	3	1/2
00846	32,5 x 17,6	3	1/3



Präsentationsmöglichkeit
presentation example

**Servierbrett „NARROW II“**

serving board
tabla de servir
planche de service

Akazienholz, mit 3 Aussparungen Ø 6 cm

acacia wood, with 3 notches Ø 6 cm
madera de acacia, con 3 ranuras Ø 6 cm
bois d'acacia, avec 3 encoches Ø 6 cm



	cm	↑ cm
00878	31 x 11	2

**passende Schälchen / suitable bowls /
cuencos adecuados / bols appropriés**



	Ø cm	↑ cm	litr.	
40686	8	4,5	0,17	stainless steel
82316	7	8	0,22	glass / 12 pcs.
85080	8	7,5	0,05	melamine / 3 pcs.
85081	8	7,5	0,05	melamine / 3 pcs.

Servierbeispiel - Lieferung ohne Gläser
delivery without glasses

**Holzbox „TABLE“**

woodbox
caja madera
base bois

Akazienholz, 3 Fächer (6,5 x 6,5 cm)

acacia wood, 3 compartments (6,5 x 6,5 cm)
madera de acacia, 3 compartimentos (6,5 x 6,5 cm)
bois d'acacia, 3 compartiments (6,5 x 6,5 cm)



	cm	↑ cm	inner size cm
11727	23,5 x 8,5	4,5	6,5 x 6,5 je Fach / each compartment

Servierbeispiel - Lieferung ohne Gläser
delivery without glasses

**Holzbox „TABLE“**

woodbox
caja madera
base bois

Akazienholz, natur

acacia wood, nature
madera de acacia, natural
bois d'acacia, naturel



	cm	↑ cm	inner size cm
11726	15 x 9,5	5	12 x 6,5

**Serviertablett**

serving tray
bandeja para servir
plateau de service

aus geöltem Eichenholz, mit 2 Griffmulden

made of oiled oak wood, with 2 recessed handles
de madera de roble aceitada, con 2 asas empotradas
en bois de chêne huilé, avec 2 poignées encastrées



	cm	↑ cm
00761	45 x 35	6



Präsentationsmöglichkeit
presentation example



Servierbrett „SHARING“

serving board
tabla de servir
planche de service



Servierbrett aus geöltem Akazienholz
serving board made of oiled acacia wood
tabla de servir de madera de acacia aceitada
planche en bois d'acacia huilé

	cm	↑ cm	Griff / handle cm
00887	51,5 x 18	1,5	8,5



2 tlg.
2 pcs.

mit Aussparung Ø 5 cm
with hole Ø 5 cm

Servierbrett

serving board
tabla de servir
planche de service



2-teilig: 1 Holzbrett aus Akazienholz + 1 Naturschieferplatte
2 pcs.: 1 wood board made of acacia wood + 1 natural slate tray
set de 2: 1 tabla de madera de acacia + 1 bandeja de pizarra natural
set de 2: 1 planche en bois d'acacia + 1 plat ardoise naturelle

	cm	↑ cm
00814	28 x 17,5	2



2 tlg.
2 pcs.

Servierbrett

serving board
tabla de servir
planche de service



2-teilig: 1 Holzbrett aus Akazienholz + 1 Naturschieferplatte
2 pcs.: 1 wood board made of acacia wood + 1 natural slate tray
set de 2: 1 tabla de madera de acacia + 1 bandeja de pizarra natural
set de 2: 1 planche en bois d'acacia + 1 plat ardoise naturelle

	cm	↑ cm	Griff / handle cm
00810	26 x 18	2	8
00811	33 x 20	2	8
00812	40 x 15	2	5
00813	43 x 12	2	12

Präsentationsmöglichkeit
presentation example



mit Hängeloch Ø 2 cm / with a handle-hole Ø 2 cm



Servierbrett „AKAZIE-SCHIEFER“

serving board
tabla de servir
planche de service



raffiniertes, rustikales Servierbrett aus Akazienholz, ausgestattet mit einem Naturschieferstreifen zur Kennzeichnung
wood with slate, markable
madera con pizarra, se puede marcar
bois avec ardoise, on peut mettre une inscription

	cm	↑ cm	Griff / handle cm
00867	30,5 x 13	1,5	10
00868	36,5 x 15	1,5	12
00869	42,0 x 18	1,5	14

**Servierbrett**

serving board
tabla de servir
planche de service



aus geöltem Akazienholz / made of oiled acacia wood / de madera de acacia aceitada / en bois d'acacia huilé

	cm	↑ cm
00793	25 x 17	1,5

**Servierbrett**

serving board
tabla de servir
planche de service



aus geöltem Akazienholz / made of oiled acacia wood / de madera de acacia aceitada / en bois d'acacia huilé

	cm	↑ cm
00897	30 x 15	2
00898	30 x 18	2
00899	35 x 25	2

**Servierbrett**

serving board
tabla de servir
planche de service



aus geöltem Akazienholz / made of oiled acacia wood / de madera de acacia aceitada / en bois d'acacia huilé

	cm	↑ cm
00792	37 x 8	2

**Servierschale**

serving bowl
cuenca de servir
bol de service



aus geöltem Akazienholz / made of oiled acacia wood / de madera de acacia aceitada / en bois d'acacia huilé

	cm	↑ cm
00790	16,5 x 9	2
00791	23,5 x 13	2

**Servierbrett „NARROW I“**

serving board
tabla de servir
planche de service



Akazienholz, mit 3 Vertiefungen Ø 4 cm / acacia wood, with 3 notches Ø 4 cm
madera de acacia, con 3 ranuras Ø 4 cm / bois d'acacia, avec 3 encoches Ø 4 cm

	cm	↑ cm
00864	22 x 8	1,5

Servierbeispiel - Lieferung ohne Gläser
delivery without glasses

passende Schälchen / fitting bowls / cuencos adecuados / bols appropriés

	Ø cm	↑ cm	litr.	
82359	5	3,5	0,035	glass / 12 pcs
82350	6	5,5	0,08	glass / 12 pcs
40685	6	3,0	0,05	stainless steel



SIMPLY WOOD

Eiche, das widerstandsfähigste europäische Holz, ist seit jeher Ausdruck von Qualität, Kraft und Energie.
Eichen werden uralte und riesengroß, sind unvergleichlich stark und standfest.

Oak, the most resistant European wood, has always been an expression of quality, strength and energy.
Oaks grow to be ancient and huge, are incomparably strong and stable.

El roble, la madera europea más resistente, siempre ha sido expresión de calidad, fuerza y energía.
Los robles llegan a ser antiguos y gigantes, son incomparablemente fuertes y estables.

Le chêne, le bois européen le plus résistant, est depuis toujours l'expression de la qualité, de la force et de l'énergie.
Les chênes deviennent très vieux et gigantesques, ils sont incomparablement forts et stables.



Servierbrett „SIMPLY WOOD“

servicing board
tabla de servir
planche de service



Eichenholz geölt, mit Aufhängeloch Ø 1,5 cm, mit Lederband

oak wood oiled, with handle hole Ø 1,5 cm, with leather strap
madera de roble aceitada, con agujero para colgar Ø 1,5 cm, con correa de cuero
bois de chêne huilé, avec trou de suspension Ø 1,5 cm, avec ruban en cuir

	cm	↑ cm	→ Griff / handle
00750	20 x 20	2	8
00751	27 x 17	2	8
00752	32 x 22	2	8



mit Lederband
with leather strap



Tablett / Sushiboard „SIMPLY WOOD“

tray / sushiboard
bandeja para sushi
plateau sushi

aus geöltem Eichenholz
made of oiled oak wood
de madera de roble aceitada
en bois de chêne huilé



	cm	↑ cm
00753	35 x 17	2

**GN 1/3 Servierbrett „SIMPLY WOOD“**

GN 1/3 serving board
GN 1/3 tabla de servir
GN 1/3 planche de service



Eichenholz geölt, mit Aussparung Ø 4 cm, mit Safrinne
oak wood oiled, with notch Ø 4 cm, with juice groove
madera de roble aceitada, con ranura Ø 4 cm, con ranura para líquidos
bois de chêne huilé, avec encoche Ø 4 cm, avec rigole

	cm	↑ cm	GN
00754	32,5 x 17,6	2	1/3

**Servierbrett**

serving board
tabla de servir
planche de service



Eichenholz, geölt, 2 Aussparungen Ø 4,5 cm, 1 Aussparung Ø 3 cm, mit 2 Griffmulden
oak wood oiled, 2 notches Ø 4,5 cm, 1 notch Ø 3 cm, with 2 recessed handles
madera de roble aceitada, 2 ranuras Ø 4,5 cm, 1 ranura Ø 3 cm, con 2 asas empotradas
bois de chêne huilé, 2 encoches Ø 4,5 cm, 1 encoche Ø 3 cm, avec 2 poignées encastrées

	cm	↑ cm
00835	15 x 9	1,5

passende Gläser / fitting glasses / tarros de vidrio adecuados / verrines appropriées

	Ø cm	↑ cm	ltr.	pcs
82350	5,5	6	0,075	12

**Servierbrett „PIZZA“**

serving board
tabla de servir
planche de service



Eichenholz geölt, mit Safrinne, mit 2 Griffmulden
oak wood oiled, with juice groove, with 2 recessed handles
madera de roble aceitada, con ranura para líquidos, con 2 asas empotradas
bois de chêne huilé, avec rigole, avec 2 poignées encastrées

	Ø cm	↑ cm
00755	24	2
00756	29	2
00757	34	2

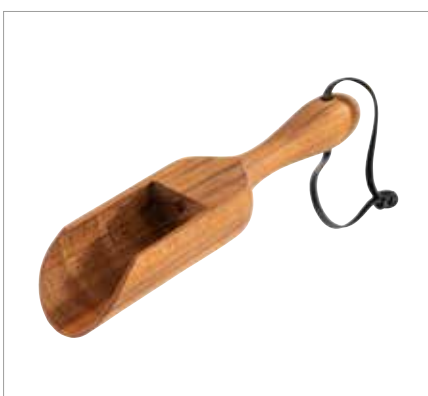
**Schaufel**

scoop
pala
pelle



aus geöltem Eichenholz, ideal für Gewürze, Körner etc.
made of oiled oak wood, ideal for spices, grains etc.
de madera de roble aceitada, ideal para especias, granos etc.
en bois de chêne huilé, idéal pour les épices, céréales, etc.

	cm	↑ cm
01026	25,5 x 6	4,5



Servierbrett „OAK“

servicing board
tabla de servir
planche de service

aus geöltem Eichenholz, Safrille, Ø 9,5 cm Aussparung

made of oiled oak, with juice groove, with hole Ø 9.5 cm

de madera de roble aceitada, con ranura para líquidos, con agujero Ø 9,5 cm

en bois chêne huilé, avec rigole, avec trou Ø 9,5 cm



	cm	↑ cm
00808	37 x 25	2



mit Safrille
with juice groove



Naturschieferplatte

natural slate tray
bandeja pizarra natural
plat ardoise naturelle

mit Safrille, Ø 9,5 cm Aussparung

with juice groove, with hole Ø 9.5 cm

con ranura para líquidos, con agujero Ø 9,5 cm

avec rigole, avec trou Ø 9,5 cm



	cm	* mm
00947	33 x 24	6 - 9



Naturschieferplatte

natural slate tray
bandeja pizarra natural
plat ardoise naturelle

mit Aussparung Ø 6 cm

with hole Ø 6 cm

con agujero Ø 6 cm

avec trou Ø 6 cm



	cm	* mm
00986	25 x 12	6 - 9



Naturschieferplatte

natural slate tray
bandeja pizarra natural
plat ardoise naturelle

mit 3 Aussparungen, Ø 6 cm

with 3 holes, Ø 6 cm

con 3 agujeros, Ø 6 cm

avec 3 trous, Ø 6 cm



	cm	* mm
00987	28 x 10	6 - 9



Naturschieferplatte „STARTER“

natural slate tray
bandeja de pizarra natural
plat ardoise naturelle carré



	cm	* mm
00937	20 x 10	6 - 9

Weck-Glas 82316

**Naturschieferplatte / Untersetzer**

natural slate tray
bandeja de pizarra natural
plateau ardoise naturelle

mit 2 Aussparungen Ø 6 cm / with 2 holes Ø 6 cm / con 2 agujeros Ø 6 cm / avec 2 trous Ø 6 cm



cm * mm

00971 15 x 8 6 - 9



00941



00942



00945



00988

Naturschieferplatte

natural slate
bandeja de pizarra natural
plateau ardoise naturelle



cm * mm

00941 24,0 x 15,0 6 - 9

00942 26,5 x 20,5 6 - 9

00945 47,0 x 10,0 6 - 9

00988 30,0 x 12,0 6 - 9

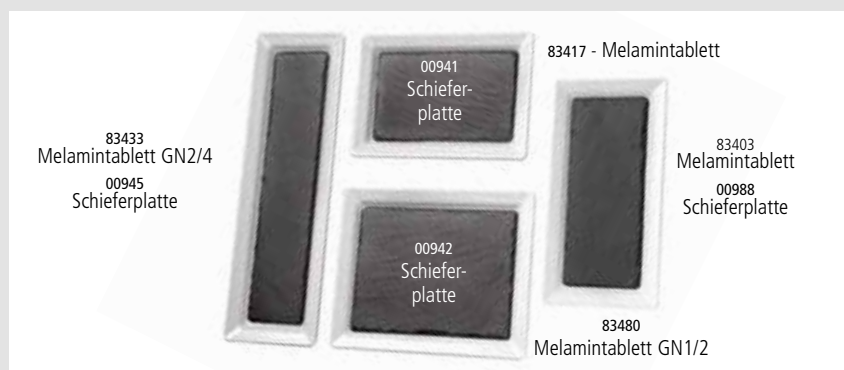
**Naturschieferplatte**

natural slate tray
bandeja de pizarra natural
plat ardoise naturelle



cm * mm

00996 45 x 30 6 - 9



00994

Naturschieferplatte

natural slate tray
bandeja de pizarra natural
plat ardoise naturelle



cm * mm

00994 25 x 25 6 - 9

00995 30 x 30 6 - 9

Naturschieferplatte, 2-teilig

natural slate tray, 2 pcs. set
bandeja de pizarra natural, set de 2
plateau ardoise naturelle, set de 2
mit Glashaube

with glass cover
con tapa de cristal
avec cloche en verre

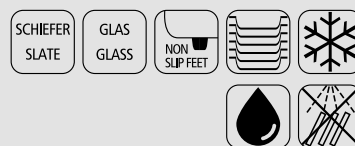

∅ cm ↑ cm * mm

00984 10,5 8 6 - 9



NEW MANGO



NEW



01050



01053



01056



01057

Schale

bowl
cuenco
bol



Mangoholz, Epoxidharz, Motiv (innen): starry sky
mango wood, epoxy resin, design (inside): starry sky
madera de mango, resina epoxi, diseño (interior): starry sky
bois de manguier, résine époxy, design (intérieur): starry sky

	Ø cm	↑ cm	ltr.
01050	20	7,5	0,8
01053	24	7,5	1,1
01056	30	10,5	3,0
01057	37	9,0	4,0



handgefertigt
handmade

NEW



Tablett / Teller

tray / plate
bandeja / plato
plateau / assiette



Mangoholz, Epoxidharz, Motiv (innen): starry sky
mango wood, epoxy resin, design (inside): starry sky
madera de mango, resina epoxi, diseño (interior): starry sky
bois de manguier, résine époxy, design (intérieur): starry sky

	Ø cm	↑ cm
01058	35,5	2,5

**Schale**bowl
cuenco
bol

Mangoholz, Epoxidharz, Motiv (innen): Sicily
 mango wood, epoxy resin, design (inside): sicily
 madera de mango, resina epoxi, diseño (interior): sicily
 bois de manguier, résine époxy, design (intérieur): sicily

	Ø cm	↑ cm	ltr.
01052	24	7,5	1,1
01055	30	10,5	3,0

handgefertigt
handmade**Schale**bowl
cuenco
bol

Mangoholz, Epoxidharz, Motiv (innen): weiß+blau
 mango wood, epoxy resin, design (inside): white+blue
 madera de mango, resina epoxi, diseño (interior): blanco+azul
 bois de manguier, résine époxy, design (intérieur): blanc+bleu

	Ø cm	↑ cm	ltr.
01051	24	7,5	1,1
01054	30	10,5	3,0

handgefertigt
handmade

TRAYS



Tablett „VINTAGE“

tray
bandeja
plateau

Antik-Edelstahl-Look

stainless steel antique look

acero estilo antiguo

acier style antique



	cm	↑ cm	
30130	26,0 x 13,5	1,5	rectangular
30131	34,0 x 18,0	1,5	rectangular
30134	32,0 x 21,5	2,0	rectangular
30132	38,0 x 26,5	1,5	rectangular
30133	25,5 x 16,0	3,0	angular
30140	20 x 14,5	1,0	oval
30141	26,5 x 19,5	1,0	oval
30142	29,0 x 22,0	1,0	oval

passende Schälchen / fitting bowls / cuencos adecuados / bols apropiés



	Ø cm	↑ cm	litr.
40655	7,5	5,5	0,17
40656	7,5	10	0,35



Tablett „TREND“

baking sheet
bandeja
plateau

ein Backblech wird zum Serviertablett

a baking sheet which becomes a serving tray

una bandeja de hornear que se convierte en una bandeja de servir

un moule qui devient un plateau de service



	cm	↑ cm
13380	32 x 21,5	2



Wachspapier „SNACKHOLDER“

greaseproof paper squares
papel alimenticio
papier alimentaire



	cm	pcs.	Motiv:
40670	42 x 25	500	Zeitung

2 tlg.
2 pcs.

85230 Ø 25,5 cm



+



33282

+



85231 Ø 33 cm

**Schale, 2-teilig „FRIDA“**bowl, 2 pcs.
cuenco, set de 2
bol, set de 2inklusive Abtropfeinsatz
including drip tray
con bandeja recogegotas
avec égouttoir

	Ø cm	↑ cm
85230	25,5	6
85231	33,0	6

Buffetständerbuffet stand
soporte para buffet
présentoir buffet

Metall, mit schwarzer Antirutschbeschichtung, für Schalen Nr. 85230, 85231

metal, with black anti-slide coating, for bowls no. 85230, 85231

metal, con revestimiento antideslizante negro, para cuencos 85230, 85231

métal, avec revêtement antidérapant noir, pour bols 85230, 85231

	Ø cm	↑ cm
33282	23 / 30,5	17

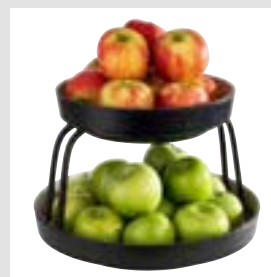
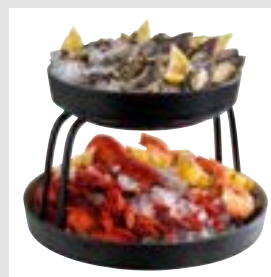
Präsentationsmöglichkeit
presentation examplemit Abtropfeinsatz
with drip tray**Servier-Muscheltopf**serving mussel pot
mejillonera para servir
casserole à moules pour servir

schwarz emailliertes Stahlblech, mit Edelstahlrand

black enamelled steel, stainless steel rim

hierro esmaltado negro, borde inox

acier émaillé noir, bord inox



	Ø cm	↑ cm	Topf / pot ltr.	Deckel / lid ltr.
00623	13,5	9,0	0,75	0,60
00625	18,0	12,0	2,60	1,40
00626	20,0	13,0	3,30	1,60
00627	24,0	13,5	5,20	2,70

Topf darf nicht erhitzt werden!
Topf ist nicht zum Kochen geeignet!



MENAGES



Menage „WOOD“

menage
menage
ménage



matt poliert, Glasbehälter mit Edelstahldeckel und Deckelverschluss

matt polished, glass with stainless steel cover
pulido mate, cristal con tapa de acero inoxidable
verre et inox poli mat, avec couvercle inox

	cm	↑ cm
40435	11,5 x 5,5	17



Menage „WOOD“

menage
menage
ménage



matt poliert, Glasbehälter mit Edelstahldeckel und Deckelverschluss

matt polished, glass with stainless steel cover
pulido mate, cristal con tapa de acero inoxidable
verre et inox poli mat, avec couvercle inox

	cm	↑ cm
40436	16 x 7,5	24,5



Menage „WOOD“

menage
menage
ménage



matt poliert, möbelschonende Unterseite

matt polished, glass with stainless steel cover
pulido mate, con tapa de acero inoxidable
verre et inox poli mat, avec couvercle inox

	cm	↑ cm
40437	15,5 x 12	24,5

Salz- und Pfefferstreuer / salt - and pepper shaker / juego de sal y pimienta / set sel et poivre

	Ø cm	↑ cm	
40438	4	9	6 Löcher - Ø 1,85 mm
40439	4	9	18 Löcher - Ø 1,35 mm

Ersatzglas Essig / Öl / spare glass vinegar / oil / cristal de recambio con tapa „aceite & vinagre“
verre huile ou vinagre

	Ø cm	↑ cm	ltr.
40442	6	18,5	0,2



Menage „ELEMENT“

menage
menage
ménage



Betonständer, Glasbehälter mit Edelstahldeckel, möbelschonende Unterseite

stand made of concrete, glass with stainless steel cover, furniture-friendly underside
soporte de hormigón, recipiente de vidrio con tapa de acero inoxidable, con base anti rayaduras

support en béton, récipient en verre avec couvercle en acier inox, revêtement antirayures

	cm	↑ cm
40410	10 x 6	17



Menage „ELEMENT“

menage
menage
ménage



Betonständer, Glasbehälter mit Edelstahldeckel und tropffreiem Kunststoff-Ausgießer, möbelschonende Unterseite

stand made of concrete, glass with stainless steel cover and non-drip nozzle-spout, furniture-friendly underside

soporte de hormigón, recipiente de vidrio con tapa de acero inoxidable y sistema antigoteo, base anti rayaduras

support en béton, récipient en verre avec couvercle en acier inox et verseur antigoutte, revêtement antirayures

	cm	↑ cm
40411	14 x 8	25



Menage „ELEMENT“

menage
menage
ménage



Betonständer, Glasbehälter mit Edelstahldeckel und Drehverschluss, möbelschonende Unterseite

stand made of concrete, glass with stainless steel cover and screw cap, furniture-friendly underside

soporte de hormigón, recipiente de vidrio con tapa de acero inoxidable y tapón de rosca, base anti rayaduras

support en béton, récipient en verre avec couvercle en acier inox et bouchon à vis, avec revêtement antirayures

	cm	↑ cm
40412	12,5 x 12,5	25

MENAGES



Menage „CLASSIC“

menage
menage
ménage

Glasbehälter mit Edelstahldeckel und Drehverschluss

glass with stainless steel cover
vidrio con tapa de acero inoxidable con rosca
en verre avec couvercle inox à visser



	cm	↑ cm
40310	10,5 x 6,5	16



Menage „CLASSIC“

menage
menage
ménage

Glasbehälter mit Edelstahldeckel und Drehverschluss

glass with stainless steel cover
vidrio con tapa de acero inoxidable con rosca
en verre avec couvercle inox à visser



	Ø cm	↑ cm
40320	10,5	16



Menage „CLASSIC“

menage
menage
ménage

Glasbehälter mit Edelstahldeckel und tropffreiem Kunststoff-Ausgießer

with stainless steel cover and non-drip nozzle-spout
vidrio con tapa inox y sistema antigoteo
verre avec couvercle inox et verseur antigoutte



	cm	↑ cm	ltr.
40440	14,5 x 8,5	23	0,2
40450	17,5 x 10,5	23	

Ersatzglas mit Deckel / spare glass with cover / vidrio con tapa / verre + couvercle

	Ø cm	↑ cm	
40312	4	9	18 Löcher - Ø 1,35 mm
40311	4	9	6 Löcher - Ø 1,85 mm

Ersatzglas mit Deckel „Essig & Öl“ / spare glass with cover „vinegar & oil“ / cristal de recambio con tapa „vinegar & oil“ / verre huile ou vinaige avec couvercle inox et verseur antigoutte

	Ø cm	↑ cm	ltr.
40441	6	18,5	0,2

Ersatzglas mit Deckel „Zahnstocher“ / spare glass with cover „toothpick“ / porta-palillos vidrio con tapa / verre à cure-dents + couvercle

	Ø cm	↑ cm
40313	4	9



Senftöpfchen, 2er Set

mustard glass, 2 pcs. set
piezas vasos mostaza, set de 2
verres à moutarde, set de 2

inklusive Löffel und Edelstahldeckel

including spoons and covers
incluye cucharas y tapas
cuillères et couvercles inclus



	Ø cm	↑ cm	ltr.	pcs.
40415	5	6	0,07	2



40476



40478



40480

Menage „PRO“

menage
menage
ménage



matt poliert, Glasbehälter mit Edelstahldeckel und tropffreiem Kunststoff-Ausgießer

matt polished, glass with stainless steel cover and non-drip nozzle-spout

pulido mate, vidrio, sistema antigoteo

poli mat et verre, insert plastique antigoutte

	cm	↑ cm
40476	12,0 x 8,0	19
40478	12,5 x 11,0	19
40480	13,0 x 11,0	19

Pfeffer- oder Salz-Glasstreuer / pepper- or salt-glass with cover / salero o pimentero de cristal con tapa / salière ou poivrière seule en verre avec couvercle inox

	Ø cm	↑ cm
40461	3	9

Essig- oder Öl-Glasbehälter / oil- or vinegar-glass with cover / aceitera-vinagrera con tapa bouteille huile ou vinaigre seule en verre et couv. inox

	Ø cm	↑ cm
40462	4,5	16



40470



40472



40474

Menage „PRO“

menage
menage
ménage



matt poliert, Glasbehälter mit Edelstahldeckel und Drehverschluss

matt polished, glass with stainless steel cover

pulido mate, vidrio y tapas con rosca

poli mat et verre, couvercle à visser

	cm	↑ cm
40470	8,5 x 5,5	11,5
40472	9,0 x 8,5	11,5
40474	10,0 x 10,0	11,5



Menage „ECONOMIC“

menage
menage
ménage



Glasbehälter mit Edelstahldeckel und Drehverschluss

glass with stainless steel cover
cristal con tapa inox a rosca
en verre avec couvercle inox à visser

	cm	↑ cm
40455	8 x 4	13



Menage „ECONOMIC“

menage
menage
ménage



Glasbehälter mit Edelstahldeckel und Drehverschluss

glass with stainless steel cover
cristal con tapa inox a rosca
en verre avec couvercle inox à visser

	cm	↑ cm
40457	8 x 8	12

Glas für Senf / glass for mustard / vaso de cristal para mostaza / pot verre seul pour la moutarde

40464



Menage „ECONOMIC“

menage
menage
ménage



Glasbehälter mit Edelstahldeckel und tropffreiem Kunststoff-Ausgießer

glasses with stainless steel cover and non-drip nozzle-spout
cristales con tapa de acero inoxidable y sistema antigoteo
en verre avec couvercle inox et insert plastique antigoutte

	cm	↑ cm
40458	11,5 x 5,5	22
40460	11,0 x 10,5	22

Pfeffer- oder Salz-Glasstreuer / pepper- or salt-glass with cover salero o pimentero de cristal con tapa / salière ou poivrière seule en verre avec couvercle inox

	Ø cm	↑ cm
40461	3	9

Essig- oder Öl-Glasbehälter / oil- or vinegar-glass with cover / aceitera-vinagrera con tapa bouteille huile ou vinaigre seule en verre et couv. inox

	Ø cm	↑ cm
40462	4,5	16

Glas für Zahnstocher / glass for tooth picks / vaso de cristal para palillos de dientes porte-cure-dents env erre

	Ø cm	↑ cm
40463	3	6



Menage
menage
menage
ménage



drehbares Gestell, Glasbehälter mit Edelstahldeckel und Drehverschluss

rotating stand, glass with stainless steel cover
soporte giratorio con piezas de vidrio y tapas inox
tournant, avec pièces en verre et couvercle inox

	Ø cm	↑ cm
40485	16	20



40446

Essig- & Öl-Menage
oil- and vinegar-menage
aceitera-vinagrera
ménage huile et vinaigre



Glasbehälter mit Deckel und tropffreiem PE-Ausgießer

glass with lid and non-drip nozzle-spout
recipiente de cristal con tapa y sistema antigoteo
pot en verre avec couvercle et système plastique antigoutte

	cm	↑ cm	ltr.
40445	10,5 x 5,5	24	0,12
40446	13,0 x 7,0	34	0,50



tropffreier Ausgießer
non-drip spout



350 ml

Essig- & Öl-Flasche „OLD FASHIONED“
oil- and vinegar bottle
botella de aceite y vinagre
bouteille d'huile et vinaigre



Glasflasche, Edelstahl - Ausgießer mit Deckel

glass bottle, stainless steel spout with lid
botella de vidrio, pico verteder de acero inoxidable con tapa
bouteille en verre, bec verseur en acier inox avec couvercle

	Ø cm	↑ cm	ltr.
40511	7	22	0,35



NEW

Spritzflasche
spray bottle
botella
bouteille



Ausgießer aus Kork, Edelstahl

cork pouring spout, stainless steel
pico de corcho, acero inox
bec verseur liège, acier inox

	cm	↑ cm	ltr.
93359	5 x 5	13	0,1



Parmesan-Menage „CLASSIC“

cheese dish
quesera parmesano
service à parmesan
schwarz matt, inklusive Löffel
black mat, with spoon
negro mate, con cuchara
noir mat, avec cuillère



	Ø cm	↑ cm	ltr.
40333	11,0	7,0	0,18

Ersatzbehälter / sparecontainer / bol de recambio / bol de rechange

	Ø cm	↑ cm	ltr.
40331	9,0	5,0	0,18



Parmesan-Menage „CLASSIC“

cheese dish
quesera parmesano
service à parmesan
hochglanzpoliert, inklusive Löffel
mirror polished, with spoon
pulido brillante, con cuchara
poli brillant, avec cuillère



	Ø cm	↑ cm	ltr.
40330	11,0	7,0	0,18

Ersatzbehälter / sparecontainer / bol de recambio / bol de rechange

	Ø cm	↑ cm	ltr.
40331	9,0	5,0	0,18



Parmesan-Menage „PROFI“

cheese dish
quesera parmesano
service à parmesan
hochglanzpoliert, inklusive Löffel
mirror polished, with spoon
pulido brillante, con bol cristal y cuchara
brillant, avec bol verre et cuillère



	Ø cm	↑ cm	ltr.
40424	9,0	6,5	0,18

Ersatzbehälter / spare container / bol de recambio / bol de rechange

	Ø cm	↑ cm	ltr.
40331	9,0	5,0	0,18



Parmesan-Menage „PRO“

cheese dish
quesera parmesano
service à parmesan
matt poliert, inklusive Löffel
matt polished, with spoon
pulido mate, con bol cristal y cuchara
poli mat, avec bol verre et cuillère



	Ø cm	↑ cm	ltr.
40482	10,5	13,0	0,18

Ersatzbehälter / sparecontainer / bol de recambio / bol de rechange

	Ø cm	↑ cm	ltr.
40331	9,0	5,0	0,18



Parmesan-Menage „ECONOMIC“

cheese dish
quesera parmesano
service à parmesan
inklusive Kunststofflöffel
with spoon
con cuchara
avec cuillère



	Ø cm	↑ cm	ltr.
40453	10,0	7,5	0,23

Ersatzbehälter / sparecontainer / bol de recambio / bol de rechange

	Ø cm	↑ cm	ltr.
40454	9,0	5,5	0,23



Ständer „URBAN“

serving stand
soporte 2 botellas
support 2 bouteilles



Metall schwarz, mit Kartenhalterung
metal black, with card holder
metal negro, con tarjetero
métal noir, avec porte-cartes

	cm	↑ cm
40414	13 x 8,5	25

Pfeffermühle / pepper mill / molinillo de pimienta / moulin à poivre

	Ø cm	↑ cm
40555	6	15,5

Salzmühle / salt mill / molinillo de sal / moulin à sel

	Ø cm	↑ cm
40556	6	15,5



mit Kartenhalterung an der Rückseite
with card holder at the back

MILLS



Pfeffermühle

pepper mill
molinillo de pimienta
moulin à poivre



aus Buchenholz, Keramikmahlwerk, Mahlgrad stufenlos einstellbar

made of beech wood, ceramic grinder, infinitely adjustable grinding degree

madera de haya, molinillo de cerámica, el grado de molino se puede ajustar de modo continuo

bois de hêtre, moulin en céramique, la finesse de mouture se peut réglée de façon continue

	Ø cm	↑ cm	Farbe / Colour
40570	5,5	15,5	
40571	5,5	15,5	
40572	6,0	23,0	
40573	6,0	23,0	



Keramikmahlwerk
ceramic grinder



einfach zu Öffnen
easy opening



einfach zu Befüllen
easy to refill



Salzmühle

salt mill
molinillo de sal
moulin à sel



aus Buchenholz, Keramikmahlwerk, Mahlgrad stufenlos einstellbar

made of beech wood, ceramic grinder, infinitely adjustable grinding degree

madera de haya, molinillo de cerámica, el grado de molino se puede ajustar de modo continuo

bois de hêtre, moulin en céramique, la finesse de mouture se peut réglée de façon continue

	Ø cm	↑ cm	Farbe / Colour
40574	5,5	15,5	
40575	5,5	15,5	
40576	6,0	23,0	
40577	6,0	23,0	



Keramikmahlwerk
ceramic grinder

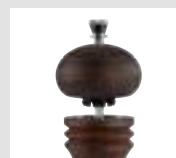

einfach zu Öffnen
easy opening





P



40535

40548

Pfeffermühle „PROFESSIONAL VINTAGE“pepper mill
molinillo de pimienta
moulin à poivre

Deutsches Buchenholz, Mahlwerk aus Carbonstahl, Mahlgrad stufenlos einstellbar
 german beechwood, mill in carbon steel, the grinding degree can be adjusted infinitely
 madera de haya alemana, molinillo de acero al carbono, el grado de molino se puede ajustar de modo continuo
 bois de hêtre d'Allemagne, moulin en acier de carbone, la finesse de mouture se peut réglée de façon continue

	Ø cm	↑ cm	Farbe / Colour
40535	5,5	15	
40537	6,0	23	
40546	5,5	15	
40548	6,0	23	

S



40536

40547

Salzmühle „PROFESSIONAL VINTAGE“salt mill
molinillo de sal
moulin à sel

deutsches Buchenholz, Mahlwerk aus Edelstahl, Mahlgrad stufenlos einstellbar
 german beechwood, mill in stainless steel, the grinding degree can be adjusted infinitely
 madera de haya alemana, molinillo de acero inoxidable, el grado de molino se puede ajustar de modo continuo
 bois de hêtre d'Allemagne, moulin en acier inox, la finesse de mouture se peut réglée de façon continue

	Ø cm	↑ cm	Farbe / Colour
40536	5,5	15	
40547	5,5	15	

P

**Pfeffermühle „GUNMETAL“**pepper mill
molinillo de pimienta
moulin à poivre

Mahlwerk aus Carbonstahl, Mahlgrad stufenlos einstellbar
 mill in carbon steel, the grinding degree can be adjusted infinitely
 molinillo de acero al carbono, el grado de molino se puede ajustar de modo continuo
 moulin en acier de carbone, la finesse de mouture se peut réglée de façon continue

	Ø cm	↑ cm
40555	6	15,5

S

**Salzmühle „GUNMETAL“**salt mill
molinillo de sal
moulin à sel

Mahlwerk aus Edelstahl, Mahlgrad stufenlos einstellbar
 mill in stainless steel, the grinding degree can be adjusted infinitely
 molinillo de acero inoxidable, el grado de molino se puede ajustar de modo continuo
 moulin en acier inox, la finesse de mouture se peut réglée de façon continue

	Ø cm	↑ cm
40556	6	15,5

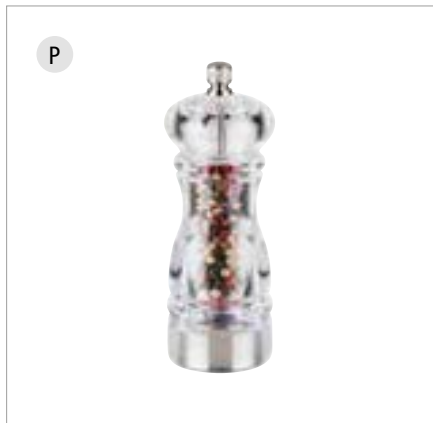

P

Pfeffermühle „PROFESSIONAL“

pepper mill
molinillo de pimienta
moulin à poivre



Mahlgrad stufenlos einstellbar

the grinding degree can be adjusted infinitely
el grado de molino se puede ajustar de modo continuo
la finesse de mouture se peut réglée de façon continue

	Ø cm	↑ cm
40540	5,5	15



S

Salzmühle „PROFESSIONAL“

salt mill
molinillo de sal
moulin à sel



Mahlgrad stufenlos einstellbar

the grinding degree can be adjusted infinitely
el grado de molino se puede ajustar de modo continuo
la finesse de mouture se peut réglée de façon continue

	Ø cm	↑ cm
40541	5,5	15



P

Pfeffermühle „DIAMOND“

pepper mill
molinillo de pimienta
moulin à poivre



Mahlwerk aus Carbonstahl, Mahlgrad stufenlos einstellbar

mill in carbon steel, the grinding degree can be adjusted infinitely
molinillo de acero al carbono, el grado de molino se puede ajustar de modo continuo
moulin en acier de carbone, la finesse de mouture se peut réglée de façon continue

	Ø cm	↑ cm
40553	6	18



S

Salzmühle „DIAMOND“

salt mill
molinillo de sal
moulin à sel



Mahlwerk aus Edelstahl, Mahlgrad stufenlos einstellbar

mill in stainless steel, the grinding degree can be adjusted infinitely
molinillo de acero inoxidable, el grado de molino se puede ajustar de modo continuo
moulin en acier inox, la finesse de mouture se peut réglée de façon continue

	Ø cm	↑ cm
40554	6	18



Naturschieferplatte / Untersetzer

natural slate tray
bandeja de pizarra natural
plateau ardoise naturelle



mit 2 Aussparungen Ø 6 cm / with 2 holes Ø 6 cm / con 2 agujeros Ø 6 cm / avec 2 trous Ø 6 cm

	cm	✦ mm
00971	15 x 8	6 - 9

P

**Pfeffermühle „FRIDA“**

pepper mill
 molinillo de pimienta
 moulin à poivre

**Mahlwerk aus Carbonstahl, Mahlgrad stufenlos einstellbar**

mill in carbon steel, the grinding degree can be adjusted infinitely
 molinillo de acero al carbono, el grado de molino se puede ajustar de modo continuo
 moulin en acier de carbone, la finesse de mouture se peut réglée de façon continue

	Ø cm	↑ cm
40549	6	15,5

S

**Salzmühle „FRIDA“**

salt mill
 molinillo de sal
 moulin à sel

**Mahlwerk aus Edelstahl, Mahlgrad stufenlos einstellbar**

mill in stainless steel, the grinding degree can be adjusted infinitely
 molinillo de acero inoxidable, el grado de molino se puede ajustar de modo continuo
 moulin en acier inox, la finesse de mouture se peut réglée de façon continue

	Ø cm	↑ cm
40550	6	15,5

P

**Pfeffermühle „COPPER“**

pepper mill
 molinillo de pimienta
 moulin à poivre

**Mahlwerk aus Carbonstahl, Mahlgrad stufenlos einstellbar**

mill in carbon steel, the grinding degree can be adjusted infinitely
 molinillo de acero al carbono, el grado de molino se puede ajustar de modo continuo
 moulin en acier de carbone, la finesse de mouture se peut réglée de façon continue

	Ø cm	↑ cm
40551	6	15

S

**Salzmühle „COPPER“**

salt mill
 molinillo de sal
 moulin à sel

**Mahlwerk aus Edelstahl, Mahlgrad stufenlos einstellbar**

mill in stainless steel, the grinding degree can be adjusted infinitely
 molinillo de acero inoxidable, el grado de molino se puede ajustar de modo continuo
 moulin en acier inox, la finesse de mouture se peut réglée de façon continue

	Ø cm	↑ cm
40552	6	15

SALT- / PEPPER MILLS



Pfeffermühle

pepper mill
molinillo de pimienta
moulin à poivre



Edelstahl, mattiert, Mahlwerk aus Carbonstahl, Mahlgrad stufenlos einstellbar

stainless steel, matt, mill in carbon steel, grinding degree infinitely adjustable
acero inoxidable, mate, molinillo de acero al carbono, Molienda ajustable de forma continua
acier inox, mat, moulin en acier de carbone, réglée de façon continue tige en acier inox

	Ø cm	↑ cm	Farbe / Colour
40580	6	13	



Salzmühle

salt mill
molinillo de sal
moulin à sel



Edelstahl, mattiert, Mahlwerk aus Edelstahl, Mahlgrad stufenlos einstellbar

stainless steel, matt, mill in stainless steel, grinding degree infinitely adjustable
acero inoxidable, mate, molinillo de acero inoxidable, Molienda ajustable de forma continua
acier inox, mat, moulin en acier inox, réglée de façon continue tige en acier inox

	Ø cm	↑ cm	Farbe / Colour
40581	6	13	



Pfeffermühle

pepper mill
molinillo de pimienta
moulin à poivre



Mahlwerk aus Carbonstahl, Mahlgrad stufenlos einstellbar

mill in carbon steel, grinding degree infinitely adjustable
molinillo de acero al carbono, Molienda ajustable de forma continua
moulin en acier de carbone, réglée de façon continue tige en acier inox

	Ø cm	↑ cm	Farbe / Colour
40582	6	13	



Salzmühle

salt mill
molinillo de sal
moulin à sel



Mahlwerk aus Edelstahl, Mahlgrad stufenlos einstellbar

mill in stainless steel, grinding degree infinitely adjustable
molinillo de acero inoxidable, Molienda ajustable de forma continua
moulin en acier inox, réglée de façon continue tige en acier inox

	Ø cm	↑ cm	Farbe / Colour
40583	6	13	

P

**Pfeffermühle „ELEMENT“**

pepper mill
molinillo de pimienta
moulin à poivre



Mahlwerk aus Carbonstahl, Mahlgrad stufenlos einstellbar

mill in carbon steel, the grinding degree can be adjusted infinitely

molinillo de acero al carbono, el grado de molino se puede ajustar de modo continuo

moulin en acier de carbone, la finesse de mouture se peut régler de façon continue

Ø cm ↑ cm

40538

6

18

S

**Salzmühle „ELEMENT“**

salt mill
molinillo de sal
moulin à sel



Mahlwerk aus Edelstahl, Mahlgrad stufenlos einstellbar

mill in stainless steel, the grinding degree can be adjusted infinitely

molinillo de acero inoxidable, el grado de molino se puede ajustar de modo continuo

moulin en acier inox, la finesse de mouture se peut régler de façon continue

Ø cm ↑ cm

40539

6

18

P

**Pfeffermühle „ELEMENT“**

pepper mill
molinillo de pimienta
moulin à poivre



Mahlwerk aus Carbonstahl, Mahlgrad stufenlos einstellbar

mill in carbon steel, the grinding degree can be adjusted infinitely

molinillo de acero al carbono, el grado de molino se puede ajustar de modo continuo

moulin en acier de carbone, la finesse de mouture se peut régler de façon continue

Ø cm ↑ cm

40557

7,5

15,5

S

**Salzmühle „ELEMENT“**

salt mill
molinillo de sal
moulin à sel



Mahlwerk aus Edelstahl, Mahlgrad stufenlos einstellbar

mill in stainless steel, the grinding degree can be adjusted infinitely

molinillo de acero inoxidable, el grado de molino se puede ajustar de modo continuo

moulin en acier inox, la finesse de mouture se peut régler de façon continue

Ø cm ↑ cm

40558

7,5

15,5

SALT- / PEPPER MILLS



Pfeffermühle

pepper mill
molinillo de pimienta
moulin à poivre



Akazienholz, Mahlwerk aus Carbonstahl, Mahlgrad stufenlos einstellbar

acacia wood, mill in carbon steel, grinding degree infinitely adjustable
madera de acacia, molinillo de acero al carbono, Molienda ajustable de forma continua
bois d'acacia, moulin en acier de carbone, réglée de façon continue tige en acier inox

	Ø cm	↑ cm	Farbe / Colour
40578	5	17	■



Salzmühle

salt mill
molinillo de sal
moulin à sel



Akazienholz, Mahlwerk aus Edelstahl, Mahlgrad stufenlos einstellbar

acacia wood, mill in stainless steel, grinding degree infinitely adjustable
madera de acacia, molinillo de acero inoxidable, Molienda ajustable de forma continua
bois d'acacia, moulin en acier inox, réglée de façon continue tige en acier inox

	Ø cm	↑ cm	Farbe / Colour
40579	5	17	■

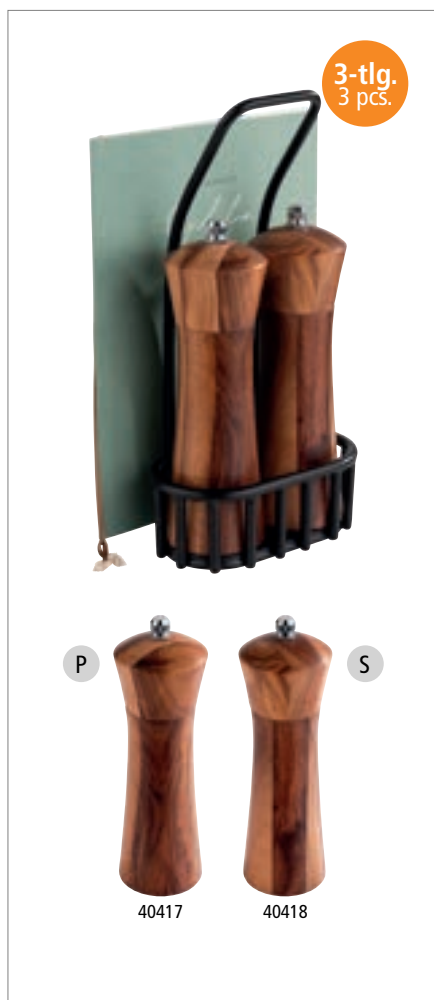

Pfeffer- und Salz-Menage „URBAN“

salt- and pepper-menage
salero-pimentero
ménage sel et poivre



3-teiliges Set, bestehend aus:

- Gestell, Metall, schwarz, mit Kartenhalterung
- Pfeffermühle aus Akazienholz mit Mahlwerk aus Carbonstahl
- Salzmühle aus Akazienholz mit Mahlwerk aus Edelstahl

3 pcs., consisting of:

- stand, metal, black, with card holder
- pepper mill made of acacia wood with grinding mechanism made of carbon steel
- salt mill made of acacia wood with grinding mechanism made of stainless steel

set de 3, compuesto por:

- soporte, metal, negro, con porta menu
- molinillo de pimienta de madera de acacia con mecanismo de molienda de acero al carbono
- molinillo de sal de madera de acacia con mecanismo de molienda de acero inoxidable

set de 3, composé de :

- support, métal, noir, avec porte-cartes
- moulin à poivre en bois d'acacia avec broyeur en acier au carbone
- moulin à sel en bois d'acacia avec broyeur en acier inox

	cm	↑ cm
40416	12 x 8,5	24

Pfeffermühle / pepper mill / molinillo de pimienta / moulin à poivre

	Ø cm	↑ cm
40417	5	17

Salzmühle / salt mill / molinillo de sal / moulin à sel

	Ø cm	↑ cm
40418	5	17



2 in 1 Salz und Pfeffermühle

2 in 1 salt and pepper mill
2 en 1 molinillo sal y pimienta
2 en 1 moulin à sel et poivre

Keramikmahlwerk, Mahlgrad einstellbar
ceramic grinder, adjustable grinding degree
molinillo de cerámica, grado de molienda ajustable
moulin en céramique, degré de mouture réglable



	cm	↑ cm	Farbe / Colour
40561	6 x 5	8	
40562	6 x 5	8	
40563	6 x 5	8	
40543	6 x 5	8	



Mahlgrad einstellbar
adjustable grinding degree

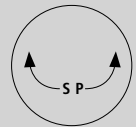

2 in 1 Salz- und Pfeffermühle

2 in 1 salt and pepper mill
2 in 1 molinillo de sal y pimienta
2 in 1 moulin à sel et poivre

Keramik Mahlwerk / ceramic mechanism / molinillo de cerámica / broyeur en céramique



	cm	↑ cm
40544	6 x 4,5	9,5



Mahlgrad einstellbar
grinder setting

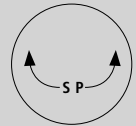

2 in 1 Salz- und Pfeffermühle

2 in 1 salt and pepper mill
2 in 1 molinillo de sal y pimienta
2 in 1 moulin à sel et poivre

Keramik Mahlwerk / ceramic mechanism / molinillo de cerámica / broyeur en céramique



	Ø cm	↑ cm
40545	7,5	18,5



Mahlgrad einstellbar
grinder setting

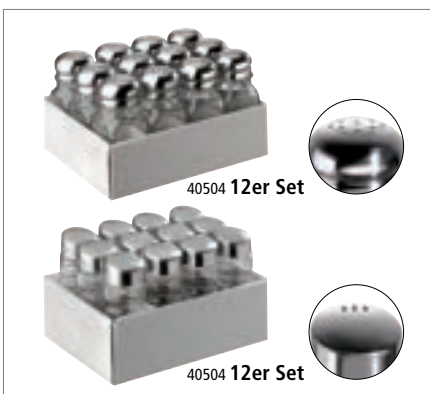
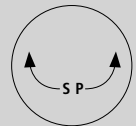

Allzweckstreuer, 12er Set

shaker, 12 pcs.
dosificador, set de 12
salières/poivrières, set de 12



	cm	↑ cm	pcs.	
40504	4 x 4	10	12	13 Löcher / 13 holes 13 agujeros / 13 trous
40505	Ø cm	↑ cm	pcs.	
	3	9	12	3 Löcher / 3 holes 3 agujeros / 3 trous

SALT- / PEPPER MILLS



Salz- und Pfefferstreuer, 2er Set

salt - and pepper shaker, 2 pcs.
piezas de sal y pimienta, set de 2
sel et poivre, set de 2



	Ø cm	↑ cm	pcs.	
40501	5	6,5	2	geriffelte Ausführung / fluted version
40507	6	10,0	2	



Ministreuer, 4er Set

mini shaker, 4 pcs.
dosificador mini, set de 4
mini-salières, set de 4



	Ø cm	↑ cm	pcs.
40503	3,5	4	4



Netzstreuer

mesh top shaker
polvoreador, tapa con malla fina
pot à épices, couvercle toile fine



	Ø cm	↑ cm	litr.
00776	5,5	7,5	0,15



Streuer fein

small hole shaker
polvoreador, tapa con agujeros pequeños
pot à épices, couvercle à petits trous



	Ø cm	↑ cm	litr.
00777	5,5	7,5	0,15



Streuer grob

large hole shaker
polvoreador, tapa con agujeros grandes
pot à épices, couvercle à grands trous



	Ø cm	↑ cm	litr.
00778	5,5	7,5	0,15



Käse- oder Gewürzstreuer

spice shaker
bote especiero
saupoudreuse à épices



	Ø cm	↑ cm	litr.
00775	5,5	7,5	0,15



Salzstreuer

salt shaker
salero
salière



Pommes-Frites Streuer mit Schraubkappe / for french fries, cover to screw / para patatas fritas, tapa de rosca / pour les frites, couvercle à visser

	Ø cm	↑ cm	
00779	8	17	Aluminium / aluminium
00772	8	17	Edelstahl / stainless steel



Holzbox „WOODY“

woodbox
caja madera
base bois



Akazienholz, 4-Fächer: 12,5 x 8 cm / acacia wood, 4 compartments: 12,5 x 8 cm
madera de acacia, 4 compartimentos: 12,5 x 8 cm / bois d'acacia, 4 compartiments : 12,5 x 8 cm

	cm	↑ cm
11649	36 x 14	12,5



Holzbox „TABLE“

woodbox
caja madera
base bois



Akazienholz, 3 Fächer: 6,5 x 6,5 cm / acacia wood, 3 compartments: 6,5 x 6,5 cm
madera de acacia, 3 compartimentos: 6,5 x 6,5 cm / bois d'acacia, 3 compartiments : 6,5 x 6,5 cm

	cm	↑ cm
11727	23,5 x 8,5	4,5

Servierbeispiel
Lieferung ohne Gläser
delivery without glasses



Holzbox „TABLE“

woodbox
caja madera
base bois



Akazienholz, 1 Fach: 12 x 6,5 cm
acacia wood, 1 compartment: 12 x 6,5 cm
madera de acacia, 1 compartimento: 12 x 6,5 cm
bois d'acacia, 1 compartiment: 12 x 6,5 cm

	cm	↑ cm
11726	15,0 x 9,5	5



Table Caddy

table caddy
caddy de mesa
caddy de table



Akazienholz, 1 Fach: 21,5 x 8 cm
acacia wood, 1 compartment: 21,5 x 8 cm
madera de acacia, 1 compartimento: 21,5 x 8 cm
bois d'acacia, 1 compartiment: 21,5 x 8 cm

	cm	↑ cm
11625	23 x 10	10



Holzbox „WOODY“

woodbox
caja madera
base bois



Akazienholz, 1 Fach: 13 x 13 cm
acacia wood, 1 compartment: 13 x 13 cm
madera de acacia, 1 compartimento: 13 x 13 cm
bois d'acacia, 1 compartiment : 13 x 13 cm

	cm	↑ cm
11650	15,0 x 15	5,5

Akazienholz, 2 Fächer: 13,5 x 13 cm / 6,5 x 13 cm
acacia wood, 2 compartments: 13,5 x 13 cm / 6,5 x 13 cm
madera de acacia, 2 compartimentos: 13,5 x 13 cm / 6,5 x 13 cm
bois d'acacia, 2 compartiments : 13,5 x 13 cm / 6,5 x 13 cm

	cm	↑ cm
11651	22,5 x 15	5,5

BUTTER DISHES



15925



15926

Butterservierer
butter dish
mantequillera
beurrier



	cm	↑ cm	ltr.
15925	Ø 9	9	0,07
15926	9 x 9	9	0,075



Butterservierer
butter dish
mantequillera
beurrier

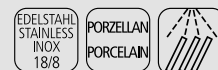

hochglanzpoliert
mirror polished
acabado brillante
poli brillant

	Ø cm	↑ cm	ltr.
15921	9	7	0,06



40668

Schale „ENAMELWARE“

bowl
cuenco
bol



	cm	↑ cm	ltr.
40667	16 x 12,0	3,5	0,20
40668	18 x 13,5	4,0	0,35



Butterdose

butter dish
mantequillera
boîte à beurre



	cm	↑ cm
00063	16 x 9,5	5,5



Eierbecher

egg holder
huevera
coquetier



	Ø cm	↑ cm
00032	8,5	2



83849

83848

Eierbecher, 4er Set

egg holder, 4 pcs. set
huevera, set de 4
coquetier, set de 4



	Ø cm	↑ cm	pcs.	Farbe / Colour
83849 new	8,5	2	4	Black
83848	8,5	2	4	White



Eierbecher, 4er Set

egg holder, 4 pcs. set
huevera, set de 4
coquetier, set de 4



	Ø cm	↑ cm	pcs.
83851	8	3	4



GRAVY BOATS



Sauciere „PROFI“

gravy boat
salsera
saucière

hochglanzpoliert, extra schwere Qualität
mirror polished, high quality
pulido brillante, alta calidad, base pesada
poli brillant, belle qualité, pied pesant



	cm	↑ cm	ltr.
40208	13 x 6,0	9,0	0,075
40204	16 x 7,5	9,0	0,125
40205	19 x 9,0	13,0	0,25
40206	22 x 10,5	13,5	0,4



Sauciere „ECO“

gravy boat
salsera
saucière

hochglanzpoliert
mirror polished
pulido brillante
poli brillant



	cm	↑ cm	ltr.
40200	18,0 x 7,5	7,0	0,10
40203	21,5 x 9,5	8,5	0,15
40201	23,5 x 10,0	10,0	0,20
40202	23,5 x 12,0	12,0	0,45



Thermo-Sauciere
insulated sauce boat
salsera isotérmica
saucière thermique



doppelwandig, Klapptdeckelverschluss, Einhandbedienung

double wall, hinged cover, one-hand operation
doble pared, tapa con bisagra, se maneja con 1 mano
double paroi, couvercle avec charnière, usage 1 main

	cm	↑ cm	ltr.
40207	19 x 12,5	13	0,4



Glocke
cloche / dome cover
campana esférica
cloche demi-sphère



außen hochglanzpoliert, innen matt poliert, mit verchromten Griff
outside mirror polished, inside matt polished, with chromeplated handle
exterior pulido brillante, interior pulido mate, pomo cromado
extérieur poli brillant, intérieur poli mat, buton chromé

	Ø cm	↑ cm
35734	29	18



Platzteller
plate tray
bajo plato
assiette de présentation



hochglanzpoliert, mit Fadendekor
mirror polished, with line edge
pulido brillante, con un filo en relieve
poli brillant, filet relief

	Ø cm
35730	30,5
36233	33,0



Platzteller
plate tray
bajo plato
assiette de présentation



hochglanzpoliert, mit Perlrand
mirror polished, with pearl edge
acabado pulido brillante, con borde aperlado
poli brillant, bord perlé

	Ø cm
35720	30,5
36323	33,0



Tischkrümelentferner
crumber
recogemigas
ramasse-miettes



matt poliert, geschliffene Edelstahlkante
matt polished, flat grinded stainless steel edge
pulido mate, borde plano de acero inoxidable rectificado
poli mat, bord plat rectifié en acier inox

	cm	↑ cm
00581	19,0 x 4,5	1

COASTERS



Untersetzer, 6er Set

coaster, 6 pcs.
posavasos, set de 6
plateau sous-verre, set de 6

hochglanzpoliert, schwere Ausführung, Rand eingerollt
mirror polished, heavy quality, rolled edge
pulido brillante, alta calidad, borde redondeado
poli brillant, bord rond, qualité extra

EDELSTAHL
STAINLESS
INOX
18/8



	Ø cm	pcs.
35711	10	6
35912	12	6



Untersetzer, 6er Set

coaster, 6 pcs.
posavasos, set de 6
plateau sous-verre, set de 6

KUNSTLEDER
LEATHERETTE



	Ø cm	pcs.
35716	11	6



Serviettenringe, 4er Set

napkin rings, 4 pcs.
servilleteros, set de 4
anneaux porte-serviette, set de 4

EDELSTAHL
STAINLESS
INOX



	Ø cm	↑ cm	pcs.
04446	4,5	2,5	4



Rechnungstablett

bill presenter
porta cuenta
porte-addition
mit Klemme für Rechnung
with clip for bill
con clip para la nota
avec clip pour la note

EDELSTAHL
STAINLESS
INOX



	cm	↑ cm
30110	17 x 11	1,0



Rechnungstablett

bill presenter
porta cuenta
porte-addition
mit Klemme für Rechnung
with clip for bill
con clip para la nota
avec clip pour la note

ABS
KUNSTSTOFF



	cm	↑ cm
30108	20 x 12	0,5

FONDUE



2,2 ltr.

65060

Fondue und Feuerzangenbowl-Set „TWO IN ONE“

fondue and fire punch bowl set
set para fondue o ponche caliente
service à fondue et à punch



13-teiliges Set aus Edelstahl bestehend aus:

1 Topf, 1 Rechaud, 1 Spritzschutz, 1 Untersetzer, 1 Schöpfkelle, 1 Feuerzange,
1 Pastenbrenner, 6 Fonduegabeln

13-piece stainless steel set consisting of:

1 pot, 1 rechaud, 1 splash guard, 1 coaster, 1 ladle, 1 fire tongs,
1 paste burner, 6 fondue forks

set de 13 piezas de acero inoxidable compuesto por:

1 olla, 1 rechaud, 1 protector contra salpicaduras, 1 trébede, 1 cazo,
1 pinza para el fuego, 1 quemador de pasta, 6 tenedores de fondue

set de 13 pièces en acier inox comprenant:

1 marmite, 1 rechaud, 1 pare-éclaboussures, 1 dessous de plat, 1 louche, 1 pince à feu,
1 brûleur à pâte, 6 fourchettes à fondue

	Ø cm	↑ cm	ltr.
65060	22	23	2,2



Kaviarkühler

caviar cooler
enfriador de caviar
rafraîchisseur de caviar



4-teilig: Glasschale Ø 10 cm / 4 pcs.: glass bowl Ø 10 cm / set de 4: bol Ø 10 cm
set de 4: bol Ø 10 cm

	Ø cm	↑ cm
01699	18	12

PLACEMATS



Tischset
placemat
mantelín
set de table



	cm		VE / unit
60580	45 x 33	beige / beige	24



rutschhemmende Unterseite
non-slip bottom



Tischset
placemat
mantelín
set de table



	cm		VE / unit
60581	45 x 33	grün / green	24



rutschhemmende Unterseite
non-slip bottom



Tischset
placemat
mantelín
set de table



	cm		VE / unit
60582	45 x 33	blau / blue	24



rutschhemmende Unterseite
non-slip bottom



Tischset
placemat
mantelín
set de table



	cm		VE / unit
60584	45 x 33	beige / beige	24



rutschhemmende Unterseite
non-slip bottom



Tischset
placemat
mantelín
set de table



	cm		VE / unit
60583	45 x 33	anthrazit / anthracite	24



rutschhemmende Unterseite
non-slip bottom



Tischset
placemat
mantelín
set de table



	cm		VE / unit
60585	45 x 33	grün / green	24



rutschhemmende Unterseite
non-slip bottom



Tischset
placemat
mantelín
set de table



	cm		VE / unit
60586	45 x 33	dunkelblau / dark blue	24



rutschhemmende Unterseite
non-slip bottom

PLACEMATS



Die umgelegten und angenähten Kanten machen diese Tischsets besonders robust. Geliefert in einer 6er Einheit.

The folded and sewn edges make these table sets particularly robust. Delivered in a packing unit of 6 pieces.

Los bordes doblados y cosidos des los mantelitos los hacen especialmente resistentes. Se entregan en una unidad de embalaje de 6 piezas.

Les bords repliés et cousus rendent ces sets de table en particulierement robustes. Livré dans un emballage de 6 pièces.



Warenträger - Tischsets

display for placemats
expositor para mantelinas de mesa
présentoir pour sets de table

12 Einschubfächer, komplett auf Rollen, 2 Feststellrollen, Lieferung demontiert

12 shelves, on rolls, 2 rolls to fix, delivery unassembled

12 niveles, 4 ruedas, desmontado (montaje fácil)

12 niveaux, 4 roues, livré démonté

	cm	↑ cm
00401	39,5 x 45	165



Tischset Feinband „TAO“

placemat fine band
mantelín cinta fina
set de table, tressage fin



	cm		VE / unit
60503	45 x 33	beige / beige	6



Tischset Feinband

placemat fine band
mantelín cinta fina
set de table, tressage fin



	cm		VE / unit
60038	45 x 33	beige braun / beige brown	6



Tischset Feinband

placemat fine band
mantelín cinta fina
set de table, tressage fin



	cm		VE / unit
60037	45 x 33	gold / gold	6

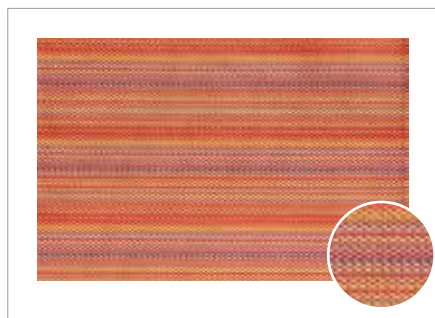

Tischset Feinband
 placemat fine band
 mantelín cinta fina
 set de table, tressage fin



	cm		VE / unit
60511	45 x 33	LINES orange, gelb / LINES orange yellow	6



Tischset Feinband
 placemat fine band
 mantelín cinta fina
 set de table, tressage fin



	cm		VE / unit
60510	45 x 33	LINES orange, rot / LINES orange red	6

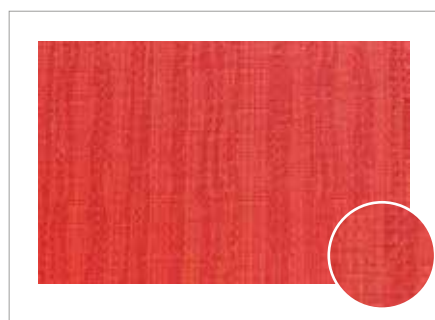

Tischset Feinband
 placemat fine band
 mantelín cinta fina
 set de table, tressage fin



	cm		VE / unit
60542	45 x 33	rot / red	6



Tischset Feinband
 placemat fine band
 mantelín cinta fina
 set de table, tressage fin



	cm		VE / unit
60042	45 x 33	türkis, grün, weiß / turquoise, green, white	6

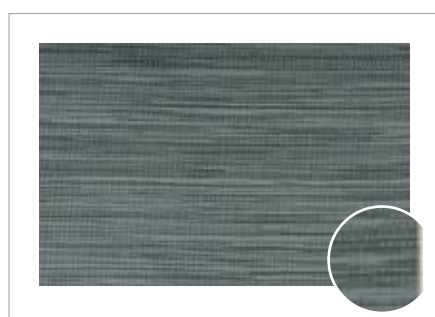

Tischset Feinband „TAO“
 placemat fine band
 mantelín cinta fina
 set de table, tressage fin



	cm		VE / unit
60508	45 x 33	hellblau, dunkelblau / light blue, dark blue	6

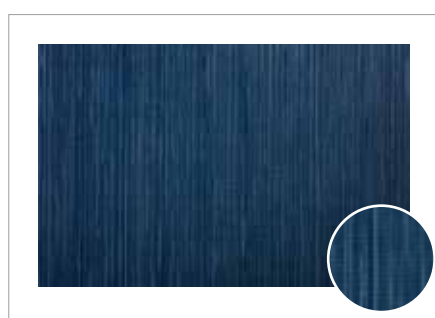

Tischset Feinband
 placemat fine band
 mantelín cinta fina
 set de table, tressage fin



	cm		VE / unit
60040	45 x 33	blau / blue	6

PLACEMATS

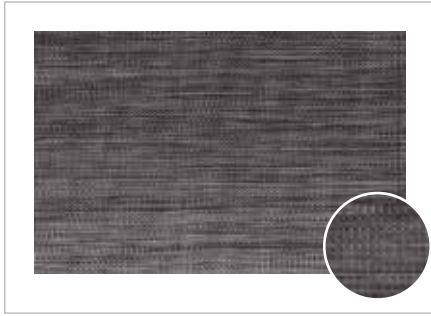

Tischset Feinband
placemat fine band
mantelín cinta fina
set de table, tressage fin



cm VE / unit
60512 45 x 33 schwarz, grau / black, grey 6



Tischset Feinband
placemat fine band
mantelín cinta fina
set de table, tressage fin



cm VE / unit
60531 45 x 33 LINES schwarz / LINES black 6

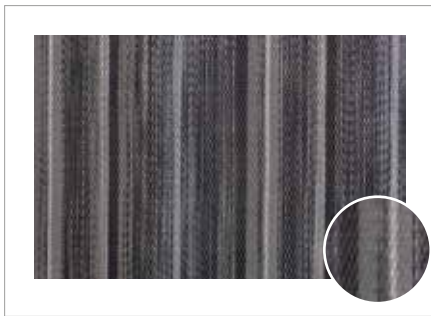

Tischset Feinband
placemat fine band
mantelín cinta fina
set de table, tressage fin



cm VE / unit
60530 45 x 33 STRIPES grau / STRIPES grey 6



Tischset Feinband
placemat fine band
mantelín cinta fina
set de table, tressage fin



cm VE / unit
60540 45 x 33 FRAMES grau / FRAMES grey 6



Tischset Feinband
placemat fine band
mantelín cinta fina
set de table, tressage fin



cm VE / unit
60541 45 x 33 FRAMES schwarz / FRAMES black 6

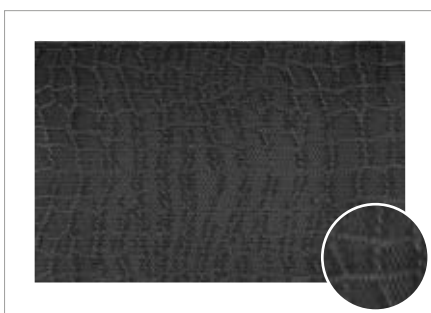

Tischset Feinband
placemat fine band
mantelín cinta fina
set de table, tressage fin



cm VE / unit
60509 45 x 33 Mosaik schwarz, grau / black, grey 6

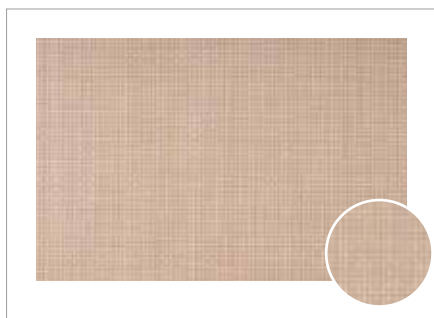

Tischset Schmalband
 placemat smallband
 mantelín cinta estrecha
 set de table tressage étroit



cm VE / unit
 60014 45 x 33 beige / beige 6

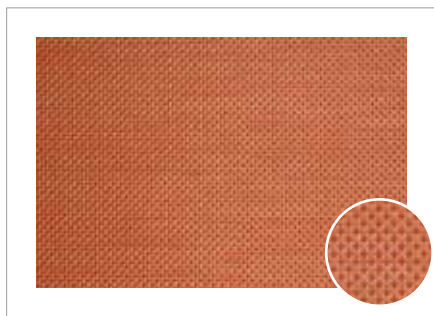

Tischset Schmalband
 placemat smallband
 mantelín cinta estrecha
 set de table tressage étroit



cm VE / unit
 60018 45 x 33 candyrot / candyred 6

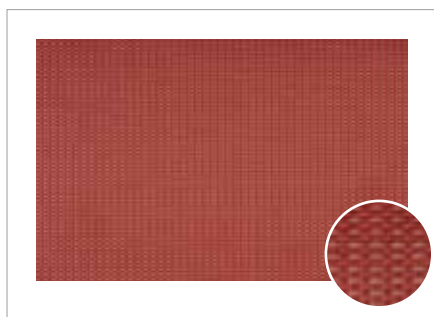

Tischset Schmalband
 placemat smallband
 mantelín cinta estrecha
 set de table tressage étroit



cm VE / unit
 60522 45 x 33 hellorange / light orange 6

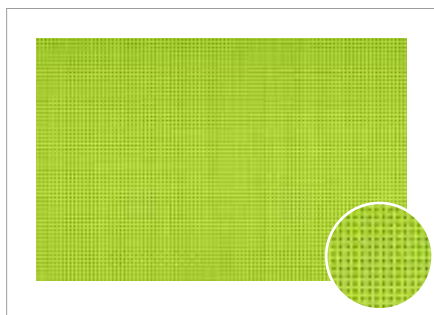

Tischset Schmalband
 placemat smallband
 mantelín cinta estrecha
 set de table tressage étroit



cm VE / unit
 60016 45 x 33 grün / green 6



Tischset Schmalband
 placemat smallband
 mantelín cinta estrecha
 set de table tressage étroit



cm VE / unit
 60528 45 x 33 grün / green 6

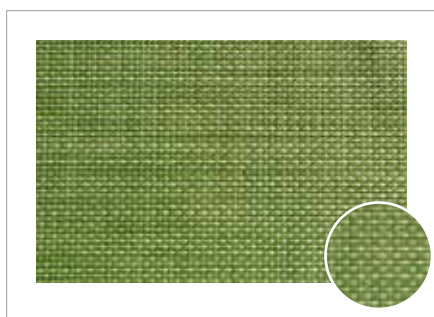

Tischset Schmalband
 placemat smallband
 mantelín cinta estrecha
 set de table tressage étroit



cm VE / unit
 60521 45 x 33 apfelgrün / apple green 6

PLACEMATS

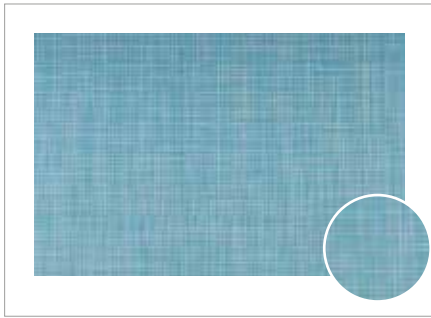

Tischset Schmalband
 placemat smallband
 mantelín cinta estrecha
 set de table tressage étroit



cm VE / unit
 60041 45 x 33 hellblau, weiß / light blue, white 6

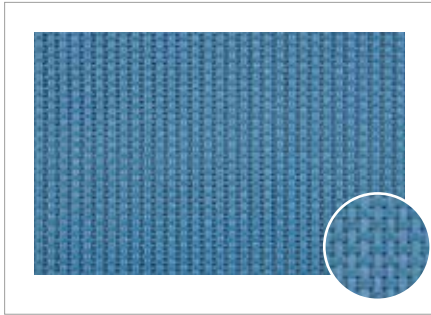

Tischset Schmalband
 placemat smallband
 mantelín cinta estrecha
 set de table tressage étroit



cm VE / unit
 60002 45 x 33 hellblau / light blue 6

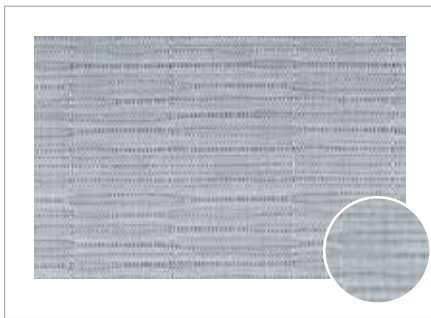

Tischset Schmalband
 placemat smallband
 mantelín cinta estrecha
 set de table tressage étroit



cm VE / unit
 60527 45 x 33 silber / silver 6

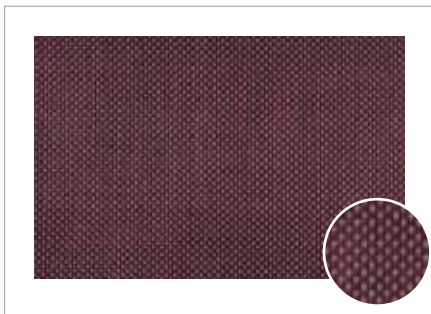

Tischset Schmalband
 placemat smallband
 mantelín cinta estrecha
 set de table tressage étroit



cm VE / unit
 60523 45 x 33 violett / purple 6



Tischset Schmalband
 placemat smallband
 mantelín cinta estrecha
 set de table tressage étroit



cm VE / unit
 60525 45 x 33 weiß / white 6

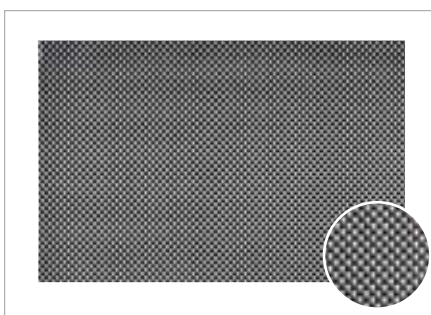

Tischset Schmalband
 placemat smallband
 mantelín cinta estrecha
 set de table tressage étroit



cm VE / unit
 60520 45 x 33 schwarz weiß / black white 6

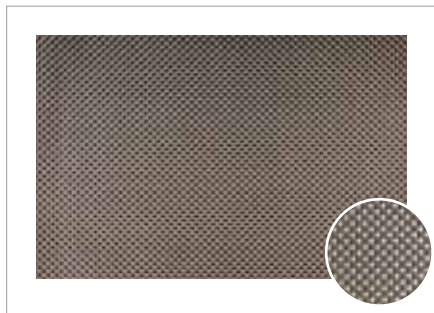

Tischset Schmalband
 placemat smallband
 mantelín cinta estrecha
 set de table tressage étroit



cm			VE / unit
60524	45 x 33	platin / platinum	6

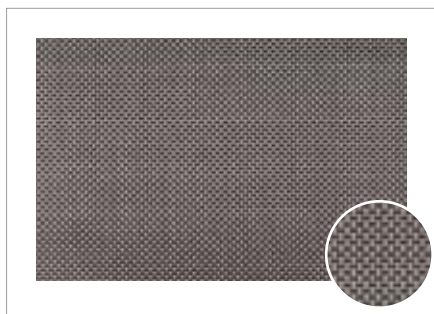

Tischset Schmalband
 placemat smallband
 mantelín cinta estrecha
 set de table tressage étroit



cm			VE / unit
60015	45 x 33	silbergrau / silbergrey	6



Tischset Schmalband
 placemat smallband
 mantelín cinta estrecha
 set de table tressage étroit



cm			VE / unit
60526	45 x 33	gold / gold	6

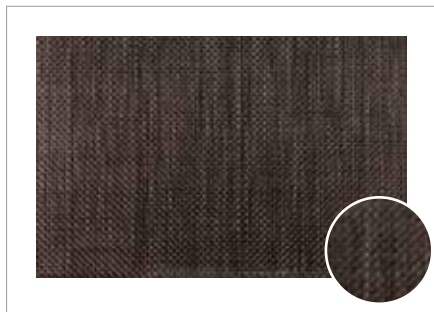

Tischset Schmalband
 placemat smallband
 mantelín cinta estrecha
 set de table tressage étroit



cm			VE / unit
60019	45 x 33	beige braun / beige brown	6

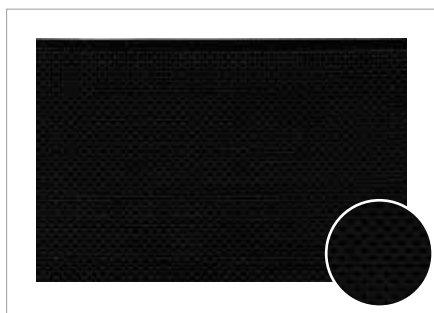

Tischset Schmalband
 placemat smallband
 mantelín cinta estrecha
 set de table tressage étroit



cm			VE / unit
60012	45 x 33	schwarz / black	6

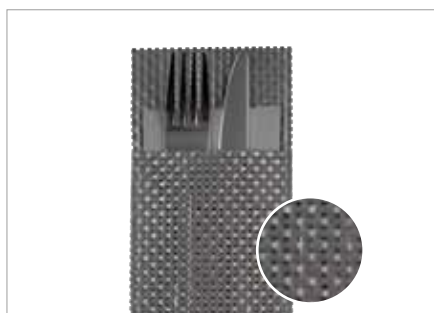

Servietten- und Bestecktaschen, 6er Set
 cutlery bag, 6 pcs. set
 bolsa cubiertos, set de 6
 pochette couverts, set de 6



cm			pcs.
60551	24 x 9	silbergrau / silbergrey	6

PLACEMATS



Servietten- und Bestecktaschen, 6er Set

cutlery bag, 6 pcs. set
bolsa cubiertos, set de 6
pochette couverts, set de 6



cm			pcs.
60552	24 x 9	beige braun / beige brown	6

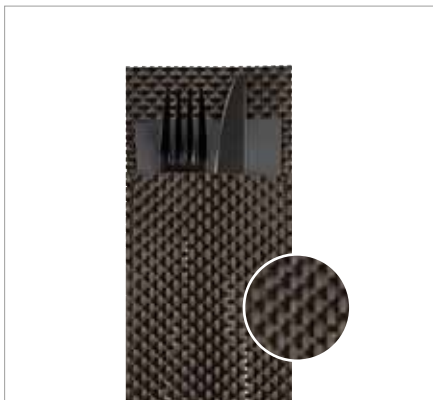

Servietten- und Bestecktaschen, 6er Set

cutlery bag, 6 pcs. set
bolsa cubiertos, set de 6
pochette couverts, set de 6



cm			pcs.
60554	24 x 9	platin / platinum	6

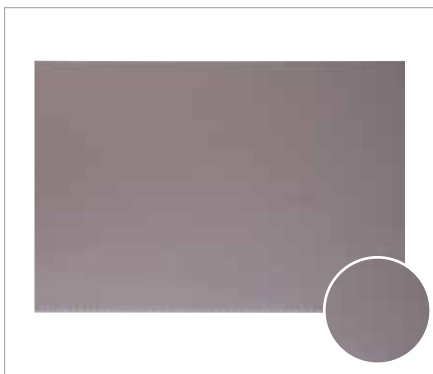

Tischset

placemat
mantelín
set de table



Kunstleder, mit Naht rundherum

imitation leather, with seam all around
imitación de cuero, con costura alrededor
similicuir, avec couture tout autour

cm			VE / unit
60044	45 x 32,5	grau / grey	6

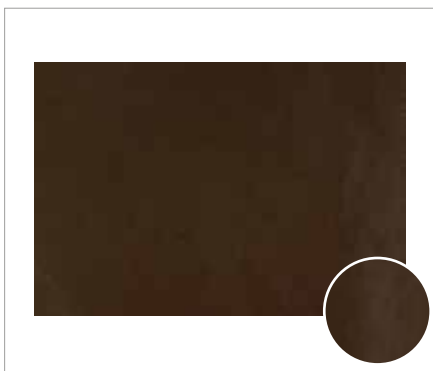

Tischset

placemat
mantelín
set de table



Kunstleder, mit Naht rundherum

imitation leather, with seam all around
imitación de cuero, con costura alrededor
similicuir, avec couture tout autour

cm			VE / unit
60045	45 x 32,5	braun / brown	6

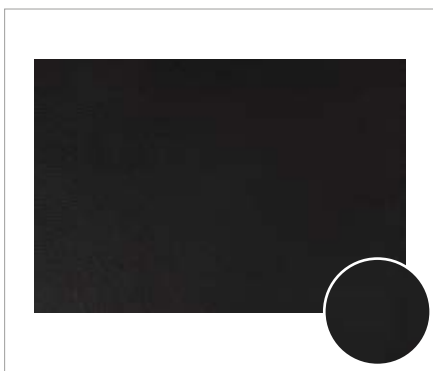

Tischset

placemat
mantelín
set de table



Kunstleder, mit Naht rundherum

imitation leather, with seam all around
imitación de cuero, con costura alrededor
similicuir, avec couture tout autour

cm			VE / unit
60046	45 x 32,5	schwarz / black	6



Tischset
 placemat
 mantelín
 set de table



rutschhemmende Unterseite
 slip resistant underside
 parte inferior antideslizante
 dessous antidérapant

cm VE / unit
 60544 45 x 30 sand / sand 6



Tischset
 placemat
 mantelín
 set de table



rutschhemmende Unterseite
 slip resistant underside
 parte inferior antideslizante
 dessous antidérapant

cm VE / unit
 60545 45 x 30 bronze/schwarz / bronze/black 6



Tischset
 placemat
 mantelín
 set de table



rutschhemmende Unterseite
 slip resistant underside
 parte inferior antideslizante
 dessous antidérapant

cm VE / unit
 60546 45 x 30 silber/schwarz / silver/black 6



60042
 türkis, grün, weiß
 turquoise, green, white

PLACEMATS

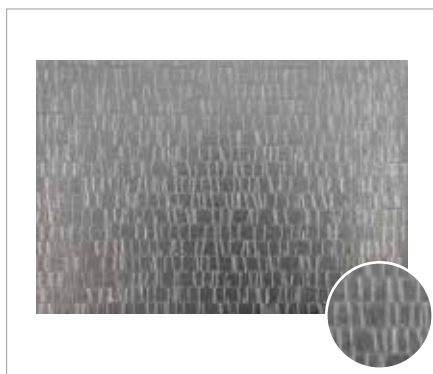

Tischset placemat mantelín set de table



rutschhemmende Unterseite
slip resistant underside
parte inferior antideslizante
dessous antidérapant

	cm		VE / unit
60543	45 x 30	silber / silver	6

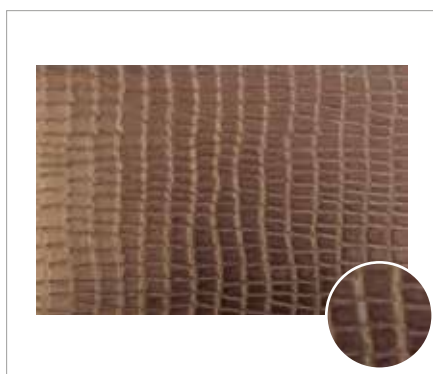

Tischset „CROCO“ placemat mantelín set de table



rutschhemmende Unterseite
slip resistant underside
parte inferior antideslizante
dessous antidérapant

	cm		VE / unit
60536	45 x 30	kupfer / copper	6

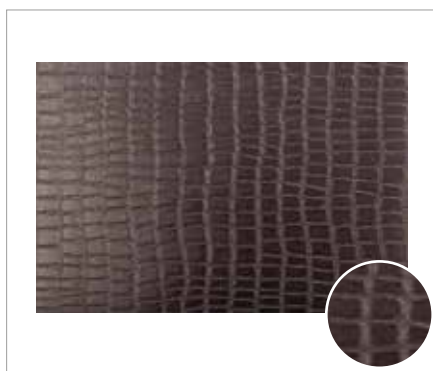

Tischset „CROCO“ placemat mantelín set de table



rutschhemmende Unterseite
slip resistant underside
parte inferior antideslizante
dessous antidérapant

	cm		VE / unit
60537	45 x 30	braun / brown	6



60044
Kunstleder, mit Naht rundherum
imitation leather, with seam all around

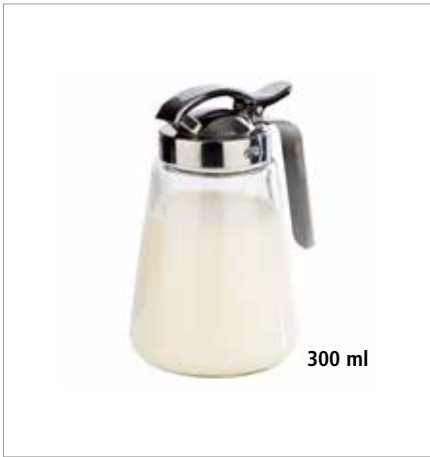

Allzweckgießer

pourer
bote vertedor universal
pot verseur universel

für Honig, Kaffeesahne, etc., Schraubdeckel aus Edelstahl

for honey, cream, etc., cover stainless steel

para miel, crema, etc., tapa inoxidable

pour le miel, le lait, la crème, etc., couvercle inox



	Ø cm	↑ cm	ltr.
00765	8,5	13,5	0,3

Ersatzglasbehälter / spare glass-container / contenedor de repuesto / récipient verre de rechange

00768



Allzweckgießer

pourer
dosificador
doseur

Schraubdeckel aus Edelstahl und Kunststoff, mit Dosierklappe

cover stainless steel and plastic, with dosing flap

acero inoxidable y tapa plástico, con tubo dosificador

couvercle en inox et plastique, avec couvercle doseure



	Ø cm	↑ cm	ltr.
40488	8	12,5	0,25



Milchkännchen, 4er Set

milk/cream jugs, 4 pcs.
pack de 4 jarritas para leche o crema
pack de 4 crémiers

hochglanzpoliert, für Kaffeesahne, mit Griff, Inhalt à 25 ml

mirror polished, for coffee-cream, with handle, capacity à 25 ml

pulido brillante, para crema de café, con asa, capacidad 25 ml

poli brillant, avec anse, 25 ml



	Ø cm	↑ cm	pcs.	ltr.
10321	3,5	3,5	4	0,025



Mini-Milchkanne „SNACKHOLDER“ 4er Set

mini milk can, 4 pcs.
lechera en formato mini, set de 4
pot à lait mini, set de 4



	Ø cm	↑ cm	ltr.	pcs.
40640	4,5	5	0,08	4



Milch- und Zucker-Set

milk and sugar set
set de crema y azúcar
set lait et sucre

5-teilig: Tablett, Milchkanne, Zuckerdose mit Deckel, Löffel, Akazienholz, Edelstahl beschichtet, schwarz

5 pcs.: tray, milk jug, sugar bowl with lid, spoon, acacia wood, stainless inox coated, black

set de 5: bandeja, jarra de leche, azucarero con tapa, cuchara, madera de acacia,

acero inoxidable revestimiento, negro

set de 5: plateau, pichet à lait, sucrier avec couvercle, cuillère, bois d'acacia, acier inox revêtement, noir



	cm	↑ cm
00634	19 x 10	10,5

SUGAR DISPENSERS



Zuckerkuigel

sugar pot
azucarero
sucrier

hochglanzpoliert, mit Roldeckel
mirror polished, rolltop cover
pulido brillante, tapa abatible
poli brillant, couvercle abattant



	Ø cm	↑ cm
00033	13,5	15



Zuckerdosierer

sugar dispenser
azucarero
sucrier

Schraubdeckel aus Edelstahl, mit Dosierrohr
cover stainless steel, with dosing tube
tapa inoxidable y tubo, con tubo dosificador
couvercle inox et tube doseur



	Ø cm	↑ cm	ltr.
40509	6	14,5	0,2



Zuckerdosierer

sugar dispenser
azucarero
sucrier

mit Schraubverschluss, Dosierrohr
cover and dosing tube
con tapa y tubo dosificador
couvercle avec tube doseur



	Ø cm	↑ cm	ltr.
40508	6,5	14,5	0,20



Zuckerdosierer

sugar dispenser
azucarero
sucrier

Schraubdeckel aus Edelstahl / cover stainless steel / tapa inoxidable / couvercle inox



	Ø cm	↑ cm	ltr.
00766	8,5	15	0,3

Ersatzglasbehälter / spare glass-container / contenedor de repuesto / récipient verre de rechange

00768



320 ml

Zuckerdosierersugar dispenser
azucarero
sucrier**Schraubdeckel aus Edelstahl, mit Dosierrohr**cover stainless steel, with dosing tube
tapa inoxidable y tubo dosificador
couvercle inoxydable et tube doseur

	∅ cm	↑ cm	ltr.
40506	7,5	17,0	0,32



250 ml

Zuckerdosierersugar dispenser
azucarero
sucrier**Schraubdeckel aus Edelstahl, mit Dosierrohr**cover stainless steel, with dosing tube
tapa inoxidable y tubo, con tubo dosificador
couvercle inox et tube doseur

	∅ cm	↑ cm	ltr.
40486	8	15	0,25



40490 150 ml

40494 250 ml

Zuckerdosierersugar dispenser
azucarero
sucrier**Schraubdeckel aus Edelstahl, mit Dosierrohr**cover stainless steel with dosing tube
tapa inoxidable y tubo dosificador
couvercle inox et tube doseur

	∅ cm	↑ cm	ltr.
40490	8,5	12	0,15
40494	8,0	15	0,25



320 ml

Zuckerdosierersugar dispenser
azucarero
sucrier**Schraubdeckel mit Klappe aus Edelstahl, mit Dosierklappe**cover stainless steel, with dosing flap
tapa acero inoxidable, con tubo dosificador
couvercle inox, avec couvercle doseur

	∅ cm	↑ cm	ltr.
40487	7,5	13,5	0,32



350 ml

Zuckerdosierer „OLD FASHIONED“sugar dispenser
azucarero
sucrier**Schraubdeckel mit Klappe aus Edelstahl, mit Dosierklappe**cover stainless steel, with dosing flap
tapa acero inoxidable, con tubo dosificador
couvercle inox, avec couvercle doseur

	∅ cm	↑ cm	ltr.
40510	7,5	14	0,35

NEW SNUG



Espressotasse „SNUG“

espresso cup
taza de espresso
tasse à espresso



Porzellan, Griff: 2 cm / porcelain, handle: 2 cm / porcelana, asa: 2 cm / porcelaine, poignée: 2 cm

	Ø cm	↑ cm	ltr.	Farbe / Colour	VE / unit
16000	6	5,5	0,08		6
16001	6	5,5	0,08		6
16002	6	5,5	0,08		6



Espresso-untertasse „SNUG“

espresso saucer
platillo de espresso
soucoupe à espresso



Porzellan / porcelain / porcelana / porcelaine

	Ø cm	↑ cm	Farbe / Colour	VE / unit
16009	11,5	2		6
16010	11,5	2		6
16011	11,5	2		6





Kaffeetasse „SNUG“

coffee cup
taza de café
tasse à café



Porzellan, Griff: 2 cm / porcelain, handle: 2 cm / porcelana, asa: 2 cm / porcelaine, poignée: 2 cm

	Ø cm	↑ cm	ltr.	Farbe / Colour	VE / unit
16003	9,5	6	0,2		6
16004	9,5	6	0,2		6
16005	9,5	6	0,2		6



Kaffeuntertasse „SNUG“

coffee saucer
platillo de café
soucoupe à café



Porzellan / porcelain / porcelana / porcelaine

	Ø cm	↑ cm		Farbe / Colour	VE / unit
16012	14,5	2,5			6
16013	14,5	2,5			6
16014	14,5	2,5			6



Cappuccinotasse „SNUG“

cappuccino cup
taza de cappuccino
tasse à cappuccino



Porzellan, Griff: 3 cm / porcelain, handle: 3 cm / porcelana, asa: 3 cm / porcelaine, poignée: 3 cm

	Ø cm	↑ cm	ltr.	Farbe / Colour	VE / unit
16006	10,5	6,5	0,3		6
16007	10,5	6,5	0,3		6
16008	10,5	6,5	0,3		6



Cappuccinountertasse „SNUG“

cappuccino saucer
platillo de cappuccino
soucoupe cappuccino



Porzellan / porcelain / porcelana / porcelaine

	Ø cm	↑ cm		Farbe / Colour	VE / unit
16015	15,5	2,5			6
16016	15,5	2,5			6
16017	15,5	2,5			6

NEW TWINZ



Gläser, 2er Set „TWINZ“

glasses, 2 pcs. set
vasos, set de 2
verres, set de 2

doppelwandig, ideal für Espresso
glass, double-walled, ideal for espresso
vidrio, doble pared, ideal para espresso
verre, à double paroi, idéal pour l'espresso



	Ø cm	↑ cm	ltr.	pcs.
10370	6	6,5	0,08	2



Gläser, 2er Set „TWINZ“

glasses, 2 pcs. set
vasos, set de 2
verres, set de 2

doppelwandig, ideal für Kaffee oder Tee
glass, double-walled, ideal für coffee or tea
vidrio, doble pared, ideal para café o té
verre, à double paroi, idéal pour le café ou le thé



	Ø cm	↑ cm	ltr.	pcs.
10371	8,5	8,5	0,23	2



Gläser, 2er Set „TWINZ“

glasses, 2 pcs. set
vasos, set de 2
verres, set de 2

doppelwandig, ideal für Latte Macchiato
glass, double-walled, ideal for Latte Macchiato
vidrio, doble pared, ideal para latte macchiato
verre, à double paroi, idéal pour le latte macchiato



	Ø cm	↑ cm	ltr.	pcs.
10372	8,5	14	0,38	2

NEW PERFECTION



NEW



Sektglas „PERFECTION“
champagne glass
copa de champán
flûte à champagne



	Ø cm	↑ cm	ltr.	VE / unit
10540	5	23	0,19	12

NEW



Weißweinglas „PERFECTION“
white wine glass
copa de vino blanco
verre à vin blanc



	Ø cm	↑ cm	ltr.	VE / unit
10541	8	21,5	0,32	12

NEW



Rotweinglas „PERFECTION“
red wine glass
copa de vino tinto
verre à vin rouge



	Ø cm	↑ cm	ltr.	VE / unit
10542	10,5	21	0,6	12

 NEW TABLE LAMPS

Die APS LED-Tischleuchten sind wiederaufladbare, kabellose, batteriebetriebene Leuchten. Ein Knopf an der Unterseite ermöglicht das Ein- und Ausschalten. Ausgestattet mit einem Dimmschalter, schaffen diese Leuchten ein perfektes Ambiente für Ihr Wohlbefinden und bieten bis zu 15-20 Stunden Betrieb mit einer einzigen Ladung. Die Leuchten sind sowohl für den Innen- als auch für den Außenbereich geeignet. Jede Leuchte wird mit einer Kontaktladestation geliefert; das Ladegerät und die Fernbedienung sind ebenfalls im Lieferumfang enthalten. Sie sind einfach aufzuladen und aufzubewahren, da sie magnetisch befestigt werden können, und verbrauchen wenig Strom.

The APS LED Table Lamps are rechargeable battery-powered cordless lamps. A "push" control on the bottom allows switching on/off. Equipped with a dimmer switch, these lamps create a perfect ambience for you your well-being and offer up to 15-20 hours of operation on a single charge. The lamps are suitable for both indoor and outdoor use. Each lamp comes with a contact charging base; the battery charger and remote control are also included. They are easy to charge and store with magnetic connectors and low in LED power consumption.

Las lámparas de mesa LED de APS son lámparas inalámbricas recargables que funcionan con pilas. Un mando "push" situado en la parte inferior permite encenderlas y apagarlas. Equipadas con un regulador de intensidad, estas lámparas crean un ambiente perfecto para su bienestar y ofrecen hasta 15-20 horas de funcionamiento con una sola carga. Las lámparas son perfectas para su uso tanto en el interior como para el exterior. Cada lámpara viene con una estación de carga por contacto; el cargador de pilas y el mando a distancia también están incluidos. Son fáciles de cargar y almacenar gracias a sus conectores magnéticos y tienen un bajo consumo de energía LED.

Les lampes de table LED d'APS sont des lampes rechargeables, sans fil et fonctionnant sur piles. Un bouton poussoir ("push") situé sur le dessous permet de les allumer et de les éteindre. Equipées d'un variateur de lumière, ces lampes créent une ambiance parfaite pour votre bien-être et offrent jusqu'à 15-20 heures de fonctionnement avec une seule charge. Les lampes conviennent aussi bien à l'intérieur qu'à l'extérieur. Chaque lampe est livrée avec une station de recharge à contact ; le chargeur de batterie et la télécommande sont également inclus. Elles sont faciles à charger et à ranger grâce à des connecteurs magnétiques et consomment peu d'énergie.

NEW



17000



17001



17002

Tischleuchte „MERLE“
table lamp
lámpara de mesa
lampe de table



inklusive Ladestation, USB Ladekabel (ohne Netzteil), Fernbedienung inkl. Batterie

charging station included, USB charging cable (without mains adapter), remote control incl. battery
con estación de carga, cable de carga USB (sin adaptador de red), mando a distancia incl. batería
avec station de charge, câble de charge USB (sans bloc d'alimentation), télécommande avec batterie

	Ø cm	↑ cm	Farbe / Colour
17000	11	30,5	
17001	11	30,5	
17002	11	30,5	



TABLE LAMPS



Tischleuchte „FINN“
 table lamp
 lámpara de mesa
 lampe de table



inklusive Ladestation, USB Ladekabel (ohne Netzteil), Fernbedienung inkl. Batterie
 charging station included, USB charging cable (without mains adapter), remote control incl. battery
 con estación de carga, cable de carga USB (sin adaptador de red), mando a distancia incl. batería
 avec station de charge, câble de charge USB (sans bloc d'alimentation), télécommande avec batterie

	Ø cm	↑ cm	Farbe / Colour
17006	13	25	White



Tischleuchte „NIELS“
table lamp
lámpara de mesa
lampe de table



inklusive Ladestation, USB Ladekabel (ohne Netzteil), Fernbedienung inkl. Batterie

charging station included, USB charging cable (without mains adapter), remote control incl. battery
con estación de carga, cable de carga USB (sin adaptador de red), mando a distancia incl. batería
avec station de charge, câble de charge USB (sans bloc d'alimentation), télécommande avec batterie

	Ø cm	↑ cm	Farbe / Colour
17007	11,5	16	



Tischleuchte „CLEO“
table lamp
lámpara de mesa
lampe de table



inklusive Ladestation, USB Ladekabel (ohne Netzteil), Fernbedienung inkl. Batterie

charging station included, USB charging cable (without mains adapter), remote control incl. battery
con estación de carga, cable de carga USB (sin adaptador de red), mando a distancia incl. batería
avec station de charge, câble de charge USB (sans bloc d'alimentation), télécommande avec batterie

	Ø cm	↑ cm	Farbe / Colour
17003	12	30,5	
17004	12	30,5	
17005	12	30,5	

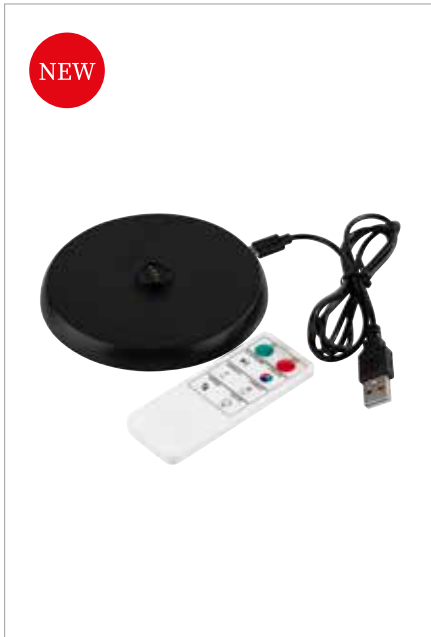

NEW

Ersatzteilset für Tischleuchten

spare parts set for table lamp
set de repuesto para lámpara
set de pièces de rechange



Set bestehend aus:

- Ladeplatte
- Kabel (USB A auf USB C)
- Fernbedienung inklusive Batterie

set consisting of:

- charging plate
- cable (USB A auf USB C)
- remote control incl. battery

set compuesto por:

- placa de carga
- cable (USB A a USB C)
- mando a distancia incl. batería

set composé de:

- plaque de chargement
- câble (USB A vers USB C)
- télécommande avec batterie

	cm	↑ cm	Farbe / Colour	
17023	11	1	■	



NEW

Rohre für Ladestation

tubes for charging station
tubos para estación de carga
tubes pour station de charge



passend zu Ladestation

suitable for charging station

para estación de carga

pour station de charge

	Ø cm	↑ cm	fits to	pcs.	Farbe / Colour
17022	2	43	17020, 17021	4	■



NEW

Ladestation, 6-fach

charging station, 6-fold
estación de carga, 6 vías
station de charge, 6 places



Platzsparend und transportsicher!

Die Tischleuchten werden auf die magnetischen Kontakte der Ladestation gestellt und können nicht von der Station fallen – kippsicherer Transport! Zwei Ladestationen können mit Hilfe von vier Verbindungsröhren (Art.-Nr. 17022) als Doppeldecker-Ladestation verbunden werden – mit einem Kabel können bis zu 12 Leuchten gleichzeitig geladen werden.

Space-saving and transport-safe!

The table lamps are placed on the magnetic contacts of the charging station and cannot fall off the station - tilt-proof transport! Two charging stations can be connected as a double-decker charging station using four connecting tubes (art. no. 17022) - up to 12 lights can be charged simultaneously with one cable.

Ahorro de espacio y transporte seguro.

Las lámparas de mesa se colocan en los contactos magnéticos de la estación de carga y no pueden caerse de la estación - ¡transporte antivuelco! Se pueden conectar dos estaciones de carga como estación de carga de dos pisos utilizando cuatro tubos de conexión (ref. 17022) - se pueden cargar hasta 12 lámparas simultáneamente con un solo cable.

Peu encombrante et sûre pour le transport !

Les lampes de table sont placées sur les contacts magnétiques de la station de recharge et ne peuvent pas tomber de la station - transport sans risque de basculement ! Deux stations de charge peuvent être reliées à l'aide de quatre tubes (art. n° 17022) de liaison pour former une station de charge à deux étages - un câble permet de charger jusqu'à 12 lampes simultanément.

	cm	↑ cm	Farbe / Colour	
17020	43 x 31,5	5	■	



NEW



Ladestation, 15-fach
charging station, 15-fold
estación de carga, 15 vías
sation de charge, 15 places



Platzsparend und transportsicher!

Die Ladestation passt maßlich perfekt auf den Servier-/Transportwagen (Art.-Nr. 11977). Die Tischleuchten werden auf die magnetischen Kontakte der Ladestation gestellt und können nicht von der Station fallen – kippsicherer Transport! Zwei Ladestationen können mit Hilfe von vier Verbindungsrohren (Art.-Nr. 17022) als Doppeldecker-Ladestation verbunden werden – mit einem Kabel können bis zu 30 Leuchten gleichzeitig geladen werden.

Space-saving and transport-safe!

The charging station fits perfectly on the serving/transport trolley (art. no. 11977). The table lamps are placed on the magnetic contacts of the charging station and cannot fall off the station - tilt-proof transport! Two charging stations can be connected as a double-decker charging station using four connecting tubes (art. no. 17022) - up to 30 lights can be charged simultaneously with one cable.

Ahorro de espacio y transporte seguro.

La estación de carga encaja perfectamente en el carro de servicio/transporte (ref. 11977). Las lámparas de mesa se colocan en los contactos magnéticos de la estación de carga y no pueden caerse de la estación - ¡transporte antivuelco! Se pueden conectar dos estaciones de carga como estación de carga de dos pisos utilizando cuatro tubos de conexión (ref. 17022) - se pueden cargar hasta 30 lámparas simultáneamente con un solo cable.

Peu encombrante et sûre pour le transport !

Les dimensions de la station de chargement s'adaptent parfaitement au chariot de service/transport (art. n° 11977). Les lampes de table sont placées sur les contacts magnétiques de la station de recharge et ne peuvent pas tomber de la station - transport sans risque de basculement ! Deux stations de charge peuvent être reliées à l'aide de quatre tubes (art. n° 17022) de liaison pour former une station de charge à deux étages - un câble permet de charger jusqu'à 30 lampes simultanément.

	cm	↑ cm	Farbe / Colour
17021	75 x 43	5	■



Servier- / Transportwagen
service trolley
carro de servicio
chariot de service



mit 2 Borden, Bordmaße 83 x 51 cm, Abstand zwischen den Borden 56 cm, Tragfähigkeit 80 kg, 4 Lenkrollen, davon 2 feststellbar, Lieferung demontiert, einfache Montage
with 2 trays, trays 83 x 51 cm, size between the trays 56 cm, total load capacity 80 kg, 4 wheels with 2 brakes, unassembled, simple assembly

con 2 bandejas de acero inoxidable mate, 83 x 51 cm, la medida entre bandejas 56 cm, capacidad total 80 kg, 4 ruedas, con 2 frenos, construcción robusta, montaje fácil
2 niveaux, 83 x 51 cm chacun, distance entre niveaux 56 cm, capacité maxi 80 kg au total, 4 roues dont 2 avec frein, construction robuste, montage facile

	cm	↑ cm
11977	91 x 59	93



Windlichter „ELEMENT“, 2er Set

wind lights, 2 pcs.
portavelas antiviento, set de 2
porte-bougies anti-vent, set de 2

Beton, Gläser klar, möbelschonende Unterseite
concrete, glass clear, furniture-friendly underside
hormigón, vidrio transparente, base anti rayaduras
béton, verre transparente, revêtement antirayures



	Ø cm	↑ cm	pcs.
03038	6	8	2

Ersatzglas / spare glass / vidrio de recambio solo / verre de rechange transparent, seul

	Ø cm	↑ cm
03098	6	5



Windlicht „ELEMENT“

wind light
porta vela
porte-bougie

Beton, Glas klar, möbelschonende Unterseite
concrete, glass clear, furniture-friendly underside
hormigón, vidrio transparente, base anti rayaduras
béton, verre transparente, revêtement antirayures



	Ø cm	↑ cm
03039	7,5	13

Ersatzglas / spare glass / vidrio de recambio solo / verre de rechange transparent, seul

	Ø cm	↑ cm
03099	7,5	9



Vase mit Glaseinsatz „ELEMENT“

flower vase with glass insert
florero con tubo de cristal
vase soliflor avec verre

Beton, Glas klar, möbelschonende Unterseite, inkl. 2 Ersatzgläsern
concrete, clear glass, furniture-friendly underside, incl. 2 spare glasses
hormigón, cristal incoloro, base anti rayaduras, incl. 2 tubos de repuesto
béton, verre transparente revêtement antirayures y compris 2 verres de rechange



	cm	↑ cm	ml
04010	10 x 4,5	12,5	25

Ersatzglas / spare glass / tubo de recambio / verre de rechange

	Ø cm	↑ cm	ml
04011	2,5	11	25



Vase

flower vase
florero
vase soliflor

Edelstahl-Look, Zinkdruckguss, vernickelt, lackiert, anlaufgeschützt, schwere Ausführung
stainless steel look, heavy zink alloy, nickel plated, laquered
aspecto acero, acabado satinado, alta calidad
aspect inox, fini poli mat, bonne qualité



	Ø cm	↑ cm	kg
04015	4,0	16,5	0,17

MENU HOLDERS



zum Einschieben der Speisekarten – schneller Austausch jederzeit möglich!
for inserting the menus - quick exchange possible at any time!



Der Kartenhalter ist völlig unkompliziert zu handhaben, denn er verfügt über eine Vorrichtung, in die die Karten einfach eingeschoben und schnell ausgetauscht werden können.

The menu holder is completely uncomplicated to handle, because it has a device into which the cards can simply be inserted and quickly exchanged.

El uso del porta menús es totalmente sencillo, ya que dispone de un dispositivo en el que simplemente se introducen las tarjetas y se intercambian rápidamente.

L'utilisation du porte-cartes est très simple, car il dispose d'un dispositif dans lequel les cartes peuvent être simplement insérées et rapidement échangées.



Kartenhalter 2-teilig

menu holder, 2 pcs.
porta menús, set de 2
porte-cartes, set de 2

Fuß aus Edelstahl, Menühalter aus Acryl
stainless steel base, menu holder made of acrylic
base de acero inoxidable, porta menús acrílico
base en acier inox, porte-cartes en acrylique



	cm	↑ cm		
71521	10,5 x 7	17	stainless steel	
71527	10,5 x 7	17	black	



Kartenhalter 2-teilig

menu holder, 2 pcs.
porta menús, set de 2
porte-cartes, set de 2

Fuß aus Edelstahl, Menühalter aus Acryl
stainless steel base, menu holder made of acrylic
base de acero inoxidable, porta menús acrílico
base en acier inox, porte-cartes en acrylique



	cm	↑ cm		
71522	15 x 7	23	stainless steel	
71528	15 x 7	23	black	



Kartenhalter 2-teilig

menu holder, 2 pcs.
porta menús, set de 2
porte-cartes, set de 2

Fuß aus Edelstahl, Menühalter aus Acryl
stainless steel base, menu holder made of acrylic
base de acero inoxidable, porta menús acrílico
base en acier inox, porte-cartes en acrylique



	cm	↑ cm		
71523	21 x 7	32	stainless steel	
71529	21 x 7	32	black	

MENU HOLDERS



Mini Staffelei, 2 teilig

easel mini, 2 pcs.
caballete mini, set de 2
chevale mini, set de 2



Ständer aus Akazienholz, Schild kann senkrecht oder waagrecht verwendet werden

acacia wood stand, sign can be used vertically or horizontally

soporte de madera de acacia, el cartel se puede utilizar vertical u horizontalmente

support en bois d'acacia, le panneau peut être utilisé verticalement ou horizontalement

	cm	↑ cm
71520	13,5 x 10,0	19
71531	19,5 x 15,0	24



waagrecht
horizontal



senkrecht
vertical



71490 Kreide-Marker
chalk marker

Inhalt ohne Stift
content without pen



Kartenhalter „ELEMENT“, 2 teilig

menu holder, 2 pcs.
soporte de tarjeta de menú, set de 2
porte-cartes de menu, set de 2



Fuß aus Beton, Menühalter aus Acryl

concrete base, acrylic menu sign / holder

base de hormigón, letrero de menú acrílico

socle en béton, plaque de menu en acrylique

	cm	↑ cm
71496	11,5 x 4,5	10
71497	15,5 x 6,5	26

Kartenhalter-Set

card holder set
portatarjetas, set
porte-cartes, set



18-teilig: 6 Kartenhalter 4 x 2,5 cm + 12 Kunststoff-Beschriftungskarten 10 x 6 cm

18 pcs.: 6 card holder 4 x 2,5 cm + 12 plastic cards of inscription 10 x 6 cm

set de 18: 6 soportes 4 x 2,5 cm + 12 tarjetas de plástico 10 x 6 cm

set de 18: 6 supports 4 x 2,5 cm + 12 étiquettes en plastique 10 x 6 cm

	cm
00022	4 x 2,5





Kartenhalter „WÜRFEL“, 4er Set

table stands, 4 pcs.
soporte de mesa, set de 4
porte-étiquettes, set de 4



inklusive 20 weiße Beschriftungskarten ca. 10 x 8 cm, mehrfach beschriftbar
including 20 white labels 10 x 8 cm, multiple inscribable
incluye 20 etiquetas blancas 10 x 8 cm, inscribible múltiple
20 étiquettes blanches incluses 10 x 8 cm, inscriptible multiple

	cm		pcs.
00078	3 x 3 x 3		4



Tafelhalter / Schild

slate sign
caballete de mesa, pizarra
plaque signalétique avec support



	cm	↑ cm	pcs.
00060	12 x 4	7	1



Kartenhalter, 2er Set

table stands, 2 pcs.
portatarjetas, set de 2
porte-cartes, set de 2



inklusive 30 Beschriftungskarten ca. 10 x 8 cm (15 x weiß + 15 x schwarz)
including 30 labels 10 x 8 cm (15 x white + 15 x black)
incluye 30 tarjetas 10 x 8 cm (15 x blanco + 15 x negro)
inclut 20 étiquettes 10 x 8 cm (15 x blanc + 15 x noir)

	cm	↑ cm	pcs.
71495	8 x 3,5	6	2



Tischkartenhalter

table stand
soporte de mesa
support de table
möbelschonende Unterseite
non-scratching undersurface
con base antirrayaduras
avec revêtement antirayures



	cm	↑ cm
00071	14 x 5,5	14

MENU HOLDERS



Schilderhalter „FLEXIBEL“

sign holder
soporte para cartelito
support pour menu de table



biegsamer Draht mit zwei Klemmen, extrem flexibel, die Klemmen lassen sich weit öffnen
bedable metal coil adds visual interest, two metal clip open
metal cromado flexible, 2 pinzas con gran apertura
métal chromé, flexible, 2 pinces à grande ouverture

	→ cm	
71470	12	ohne Schilder / without signs sin cartelitos / sans étiquette
71471	23	ohne Schilder / without signs sin cartelitos / sans étiquette
71480	12	inkl. 10 Schilder 11879 / incl. 10 signs 11879 con 10 cartelitos 11879 / avec 10 étiquettes 11879

Schilder, 10er Set / signs, 10 pcs. / set de 10 cartelitos / set de 10 étiquettes

	cm	
11879	7,7 x 5,2	
12879	5,0 x 3,0	



Tischaufsteller 2er Set

table stands, 2 pcs.
caballetes de mesa, set de 2
chevalets de table, set de 2



	cm	↑ cm		pcs.
00017	5,5 x 5	3,5	reserviert	2
00013	5,5 x 5	3,5	reserved	2
00572	5,5 x 5	3,5	no smoking	2



Beschriftungsetiketten

labeling labels
etiquetas
étiquettes



12 Bögen mit je 6 Motiven, selbstklebend, mit wasserlöslichem Stift beschreibbar

12 sheets includes 6 self-adhesive and removable labels, use regular chalkboard markers and wipe clean with a damp cloth

12 hojas, cada una con 6 motivos autoadhesivos, se pueden marcar con un rotulador lavable con agua

12 feuilles chacune avec 6 motifs autoadhésifs, on peut écrire avec un stylo lavable à l'eau

	cm	Farbe / Colour
00069	8,0 x 4,5	■



Kreide-Marker, Stärke 2 mm, 2er Set

chalk marker, 2 pcs.
rotulador de tiza, set de 2
marqueur a la craie liquide, set de 2



Zum Gestalten und Beschriften von Tafeln, Glas und fast allen geschlossenen Oberflächen, deckende Flüssigkreide auf Wasserbasis, feucht abwischbar

For decorating and writing on boards, glass and almost all non-porous surfaces, opaque water-based liquid chalk, wet-wipeable

Rotuladores para pizarra de tiza líquida para decorar y escribir sobre pizarras, cristales y casi todas las superficies no porosas. Tiza líquida opaca al agua que se pueda borrar con un trapo

Pour décorations et inscriptions sur tableaux, verre et presque toutes les surfaces non poreuses, craie liquide opaque à base d'eau, effaçable avec un chiffon humide

	Ø cm	↑ cm	Farbe / Colour	pcs.
71490	1	13	■	2
71491	1	13	■	2



Kartenhalter, 4er Set

table stands, 4 pcs.
portatarjetas, set de 4
porte-cartes, set de 4



hochglanzpoliert, inklusive 20 schwarze Beschriftungskarten aus Polypropylen
mirror polished, including 20 black cards made of polypropylene
pulido brillante, incluye 20 tarjetas negras de polipropileno
poli miroir, inclut 20 étiquettes noires en polypropylène

	Ø cm	↑ cm	pcs.	Farbe / Colour	
71510	5	10,5	4		stainless steel
71513	5	15,5	4		stainless steel
71516	5	20,5	4		stainless steel



Kartenhalter, 4er Set

table stands, 4 pcs.
portatarjetas, set de 4
porte-cartes, set de 4



hochglanzpoliert, inklusive 20 schwarze Beschriftungskarten aus Polypropylen
mirror polished, including 20 black cards made of polypropylene
pulido brillante, incluye 20 tarjetas negras de polipropileno
poli miroir, inclut 20 étiquettes noires en polypropylène

	Ø cm	↑ cm	pcs.	Farbe / Colour	
71512	5	10,5	4		gunmetal



Beschriftungskarten, 10er Set

designation cards, 10 pcs.
tarjetas, set de 10
étiquettes, set de 10



	cm	✱ mm	pcs.
00037	7,5 x 5	0,4	10



Bankettkartenständer

menu stand / table number
porta-etiqueta o carta de sobremesa
porte-étiquette de table, porte-menu, ou n° de table



hochglanzpoliert, schwere Qualität
mirror polished, heavy gauge
pulido brillante, alta calidad
poli brillant, belle qualité

	Ø cm	↑ cm
71460	7,5	18,5
71461	7,5	29



Tischkartenhalter, 4er Set

table stands, 4 pcs.
pinzas porta-etiquetas, set de 4
porte-étiquettes à pince, set de 4



hochglanzpoliert, schwerer Fuß, inklusive 20 weiße Beschriftungskarten
mirror polished, heavy foot, including 20 white labels
pulido brillante, incluye 20 etiquetas en blanco
poli brillant, inclut 20 étiquettes blanches

	Ø cm	↑ cm	pcs.
00070	4	10	4

MENU HOLDERS



Tischaufsteller, 10er Set

table stands, 10 pcs.
caballes de mesa, set de 10
chevalets de table, set de 10



Ecken abgerundet
corners rounded
esquinas redondeadas
coins arrondies

	cm	↑ cm	pcs.
00011	7,5 x 3,5	5	10
00012	10,5 x 6	6,5	10



Kartenhalter, 2er Set

card holder, 2 pcs.
soporte de mesa, set de 2
support de table, set de 2



inklusive 40 Beschriftungskarten, durch Magnete einfach zusammenklappbar
including 40 cards, easily foldable with magnets
incluye 40 tarjetas, fácil de plegar, con imanes
inclut 40 étiquettes, fácil à plier, avec aimants

	cm	↑ cm	pcs.
00076	9 x 3	5,5	2



Kartenhalter, 2er Set

menu holder, 2 pcs.
porta cartas de mesa, set de 2
supports pour menu de table, set de 2



Rubberwood / rubber wood / madera de goma / bois d'hévéa

	cm	↑ cm	pcs.
00023	8,5 x 6	4,5 / 8,5	2



Kartenhalter, 2er Set

menu holder, 2 pcs.
porta cartas de mesa, set de 2
porte-menus de table, set de 2



matt poliert
matt polished
pulido mate
poli mat

	cm	↑ cm	pcs.
00021	8,5 x 4	4 / 8,5	2



Tischkartenhalter
 table stand
 soporte-carta para la mesa
 support pour menu de table
matt poliert
 matt polished
 pulido mate
 poli mat



	cm	↑ cm	pcs.
00030	8 x 7,0	2	1
00036	6 x 4,5	4	1



Kartenhalter-Set, 4er Set
 table stands, 4 pcs.
 portatarjetas, set de 4
 porte-cartes, set de 4
inklusive 30 Beschriftungskarten (15 x weiß + 15 x schwarz)
 including 30 labels (15 x white + 15 x black)
 incluye 30 tarjetas (15 x blanco + 15 x negro)
 inclut 20 étiquettes (15 x blanc + 15 x noir)



	cm	↑ cm	pcs.
71492	3 x 3	3	4
71493	3 x 3	3	4
71494	3 x 3	12	4



Kartenhalter, 4er Set
 table stands, 4 pcs.
 soportes de mesa, set de 4
 upport de table, set de 4
inklusive 20 weiße Beschriftungskarten ca. 10 x 8 cm
 including 20 white labels 10 x 8 cm
 incluye 20 etiquetas blancas 10 x 8 cm
 20 étiquettes blanches incluses 10 x 8 cm



	cm	↑ cm	pcs.	Farbe / Colour
00074	3 x 3	12	4	light blue



Kartenhalter, 4er Set
 table stands, 4 pcs.
 soportes de mesa, set de 4
 support de table, set de 4
Rubberwood, inklusive 20 weiße Beschriftungskarten ca. 10 x 8 cm
 rubber wood, including 20 white labels 10 x 8 cm
 madera de goma, incluye 20 etiquetas blancas 10 x 8 cm
 bois d'hévéa, 20 étiquettes blanches incluses 10 x 8 cm



	cm	↑ cm	pcs.	Farbe / Colour
00700	2,5 x 2,5	12	4	light brown

CUTLERY BINS

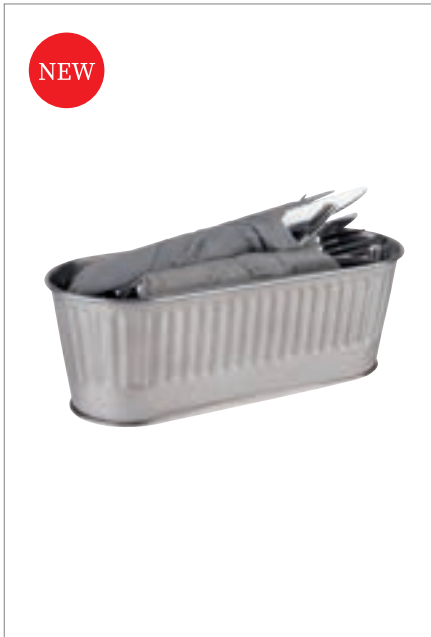

Besteckbehälter / Korb

cutlery bin / basket
 porta cubiertos / cesta
 range-couverts / corbeille
matt poliert, Boden: 29 x 8,5 cm
 matt polished, base: 29 x 8,5 cm
 pulido mate, base: 29 x 8,5 cm
 poli mat, fond: 29 x 8,5 cm

EDELSTAHL
 STAINLESS
 INOX
 18/0



	cm	↑ cm	ltr.	Farbe / Colour
11752	29,5 x 12	10	2	■



Präsentationsmöglichkeit
 presentation example



Besteckbehälter / Korb

cutlery bin / basket
 porta cubiertos / cesta
 range-couverts / corbeille
Boden: 29 x 8,5 cm
 base: 29 x 8,5 cm
 base: 29 x 8,5 cm
 fond: 29 x 8,5 cm

EDELSTAHL
 STAINLESS
 INOX
 18/0



	cm	↑ cm	ltr.	Farbe / Colour
11753	29,5 x 12	10	2	□



Präsentationsmöglichkeit
 presentation example

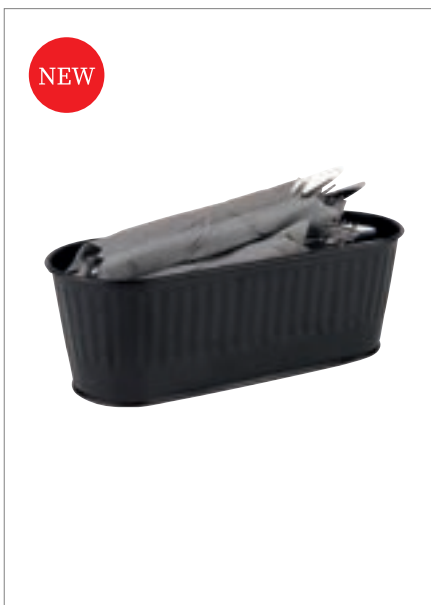

Besteckbehälter / Korb

cutlery bin / basket
 porta cubiertos / cesta
 range-couverts / corbeille
Boden: 29 x 8,5 cm
 base: 29 x 8,5 cm
 base: 29 x 8,5 cm
 fond: 29 x 8,5 cm

EDELSTAHL
 STAINLESS
 INOX
 18/0



	cm	↑ cm	ltr.	Farbe / Colour
11754	29,5 x 12	10	2	■



Präsentationsmöglichkeit
 presentation example

NEW

**Besteckbehälter „ELEMENT“**

cutlery bin
porta cubiertos
range-couverts



möbelschonende Unterseite, 3 Fächer, Bodeneinlagen aus Silikon, zum Schonen der Messerspitzen

furniture-friendly underside, 3 compartments, silicone insert to protect the knife tips
con base anti rayaduras, 3 compartimentos, inserto de silicona para proteger los cuchillos
avec revêtement antirayures, 3 compartiments, insert en silicone pour protéger les couteaux

	cm	↑ cm	Farbe / Colour
11750	13 x 13	14,5	



möbelschonende Unterseite
furniture-friendly underside

NEW

**Besteckbehälter „DART“**

cutlery bin
porta cubiertos
range-couverts



3 Fächer, Bodeneinlagen aus Silikon, zum Schonen der Messerspitzen

3 compartments, silicone insert to protect the knife tips
3 compartimentos, inserto de silicona para proteger los cuchillos
3 compartiments, insert en silicone pour protéger les couteaux

	Ø cm	↑ cm	Farbe / Colour
11755	12	25	



Präsentationsmöglichkeit
presentation example

Besteckbehälter „ELEMENT“

cutlery bin
recipiente para cubiertos
récipients pour couverts



mit Abflussloch, mit Besteck Logo, Bodeneinlagen aus Silikon zum Schonen des Bestecks, möbelschonende Unterseite

with drain hole, with cutlery logo, silicone floor inserts for saving the points of knives, furniture-friendly underside
con orificio de drenaje, con logotipo de cubertería, soporte de silicona para proteger las puntas de los cuchillos, con base antirrayaduras
avec le trou de drainage, avec le logo de coutellerie, insert de silicone pour protéger les pointes des couteaux, avec base revêtue antirayures

	Ø cm	↑ cm
00018	11	14



CUTLERY BINS



Besteckbehälter, drehbar

cutlery bin, rotatable
porta cubiertos, giratorio
range-couverts, rotatif

innen: mattiert, inklusive herausnehmbarem
Einteiler (3 Fächer), möbelschonende Unterseite

inside: matt finish, including removable, divider (3 compartments),
furniture-friendly underside, Silicone base insert

interior: mate, con separador extraíble
(3 compartimentos), con base anti rayaduras, inserto de silicona

intérieur: mat, avec compartiment amovible
(3 compartiments), base revêtement antirayures, insert en silicone



	Ø cm	↑ cm	Farbe / Colour
11747	13	16,5	
11748	13	16,5	



Besteckköcher

cutlery basket
cesta para cubiertos
corbeille à couverts

Kunststoff weiß / white plastic / plástico blanco / plastique blanc

	Ø cm	↑ cm
11998	9,5	13,5

matt poliert / matt polished / pulido mate / poli mat

	Ø cm	↑ cm
11999	9,5	13,5



Tischreste-/Besteckbehälter „TOP CHROME“

table waste bin / cutlery bin
papelera de sobremesa / recipiente para cubiertos
poubelle de table / récipients pour couverts

mit verchromten Rand / with chrome plated ring / con anillo cromado / avec bord chromé

	Ø cm	↑ cm	litr.	Farbe / Colour
00025	13	15	1	
00026	13	15	1	



Tischreste-/Besteckbehälter „BASE CHROME“

table waste bin / cutlery bin
papelera de sobremesa / recipiente para cubiertos
poubelle de table / récipients pour couverts

mit verchromten Boden / with chrome bottom / con base cromada / avec base chromée

	Ø cm	↑ cm	litr.	Farbe / Colour
00019	13	15	1,3	
00020	13	15	1,3	





Besteckkorb „ECONOMIC“
cutlery dispenser
dispensador de cubiertos
corbeille à couverts



	Ø cm	↑ cm	Farbe / Colour
40130	12	15	
40007	12	15	
40012	12	15	
40013	12	15	



Besteckkorb „ECONOMIC“
cutlery dispenser
dispensador de cubiertos
corbeille à couverts



	cm	↑ cm	Farbe / Colour
40131	27 x 10	4,5	
40009	27 x 10	4,5	
40010	27 x 10	4,5	
40011	27 x 10	4,5	



Besteckbehälter
cutlery bin
recipiente para cubiertos
récipients pour couverts



Behälter aus Edelstahl, matt poliert
container made of stainless steel, matt polished
contenedor de acero inoxidable, pulido mate
conteneur en acier inox, poli mat

	Ø cm	↑ cm
11921	10	10,0
11922	12	13,5

WASTE BINS



NEW

Tischrestebehälter

table garbage bin
papelera de sobremesa
poubelle de table



Farbe: whisper white, abnehmbarer Schwingdeckel, mit Bajonettverschluss

colour: whisper white, removable swing cover, with bayonet lock

color: blanco susurro, tapa basculante desmontable, con cierre de bayoneta

couleur: blanc chuchoté, couvercle basculant démontable, avec fermeture à baïonnette

	Ø cm	↑ cm	ltr.	Farbe / Colour
40801	12	17	1,2	



NEW

Tischrestebehälter

table garbage bin
papelera de sobremesa
poubelle de table



Farbe: smoke green, abnehmbarer Schwingdeckel, mit Bajonettverschluss

colour: smoke green, removable swing lid, with bayonet lock

color: smoke green, tapa abatible extraíble, con cierra de bayoneta

couleur: smoke green, couvercle basculant amovible, verrouillage par baïonnette

	Ø cm	↑ cm	ltr.	Farbe / Colour
40802	12	17	1,2	



NEW

Tischrestebehälter

table garbage bin
papelera de sobremesa
poubelle de table



schwarz, abnehmbarer Schwingdeckel, mit Bajonettverschluss

black, removable swing cover, with bayonet lock

negro, tapa basculante desmontable, con cierre de bayoneta

noir, couvercle basculant démontable, avec fermeture à baïonnette

	Ø cm	↑ cm	ltr.	Farbe / Colour
40800	12	17	1,2	



00029

Tischrestebehälter

table garbage bin
papelera de sobremesa
poubelle de table



matt poliert, abnehmbarer Schwingdeckel, mit Bajonettverschluss

matt polished, swing cover, cover removable, with bayonet lock

pulido mate, tapa basculante desmontable, con cierre de bayoneta

poli mat, couvercle basculant démontable, avec fermeture à baïonnette

	Ø cm	↑ cm	ltr.	Farbe / Colour
00029	12	17	1,2	
00027	10	13	0,7	



Table Caddy „COUNTRY STYLE“

table barrel
caddy de mesa
caddy de table



cooler Country-Style, nicht für den direkten Kontakt mit Lebensmittel verwendbar
condiment and cutlery holders or even for food presentation, the mini barrels should not come into contact with food, they should be lined with our greaseproof paper
estilo campestre, no aptos para el contacto directo con alimentos, sólo usando papel alimenticio de style champêtre, pas de contact direct avec aliments, seulement en utilisant papier alimentaire

	Ø cm	↑ cm
11930	17,5	8,5
11931	11,5	14,0



Tischrestebehälter

table garbage bin
papelera de sobremesa
poubelle de table



	Ø cm	↑ cm	ltr.	Farbe / Colour
02038	11	14	0,9	White
02039	11	14	0,9	Black



Tischrestebehälter

table garbage bin
papelera de sobremesa
poubelle de table



	Ø cm	↑ cm	ltr.
00311	14	15	1,2



Tischrestebehälter

table garbage bin
papelera de sobremesa
poubelle de table



Kunststoff weiß / granit, abnehmbarer Schwingdeckel
white plastic, swing cover, cover removable
plástico blanco/granito, tapa basculante desmontable
plastique blanc/gris chiné, couvercle basculant démontable

	Ø cm	↑ cm	ltr.
00031	12	18	1,4





Baskets

PROFI LINE	358
GN LINE	362
ECONOMIC	364
BASIC	368
BASKETS COVERS	369
BREAD BASKETS	370
SVART	374
URBAN	378
STAINLESS STEEL BASKETS	382
BASKETS RISERS	385
SUPERBOX	386

PROFI LINE



hellbeige / light beige
beis claro / beige clair

beige / beige
beis / beige

braun / brown
marrón / marron

schwarz / black
negro / noir

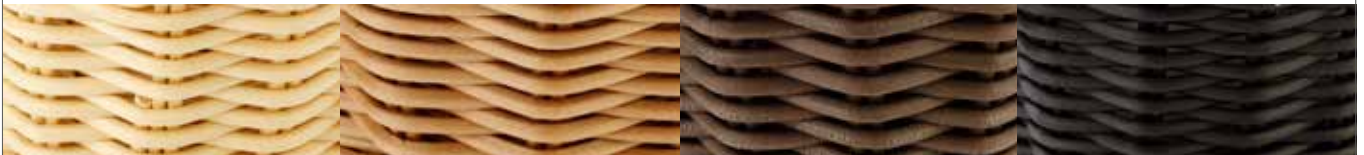

50915

50918

Korb "PROFI LINE"
basket baker size
cesta tamaño panaderia
corbeille dimensions „boul-pâte“



	cm	↑ cm	Farbe / Colour
50915	60 x 40	5	hellbeige
50918	60 x 40	5	schwarz



50910

50913

Korb "PROFI LINE"
basket baker size
cesta tamaño panaderia
corbeille dimensions „boul-pâte“



	cm	↑ cm	Farbe / Colour
50910	60 x 20	5	hellbeige
50913	60 x 20	5	schwarz



50908

50710

Korb "PROFI LINE"
basket baker size
cesta tamaño panaderia
corbeille dimensions „boul-pâte“



	cm	↑ cm	Farbe / Colour
50905	40 x 30	5	hellbeige
50908	40 x 30	5	schwarz

	cm	↑ cm	Farbe / Colour
50710	40 x 30	10	hellbeige
50712	40 x 30	10	schwarz



Systemkorb, gestäbt „PROFI LINE“

basket
cesta
corbeille



	cm	↑ cm	Farbe / Colour
50305	45 x 40	27 / 16	



Systemkorb „PROFI LINE“

basket
cesta
corbeille



	cm	↑ cm	
50400	40 x 50	25 / 14	



GN 1/1 Korb „PROFI LINE“

GN 1/1 basket
GN 1/1 cesta
GN 1/1 corbeille



	cm	↑ cm	Farbe / Colour
50722	53 x 32,5	10	



Korb, rund „PROFI LINE“

basket, round
cesta redonda
corbeille ronde



	Ø cm	↑ cm	Farbe / Colour
50205	31 / 37	12 / 6	



Korb, rund „PROFI LINE“

basket, round
cesta redonda
corbeille ronde



	Ø cm	↑ cm	Farbe / Colour
50210	37	9	



Korb, rechteckig „PROFI LINE“

basket, rectangular
cesta, rectangular
corbeille, rectangulaire



	cm	↑ cm	Farbe / Colour
50702	26,5 x 19	7	

	cm	↑ cm	Farbe / Colour
50707	31 x 21	9	

PROFI LINE



Baguette Korb, oval „PROFI LINE“

baguette basket, oval
cesta de baguette, oval
corbeille à baguettes, ovale



	cm	↑ cm	Farbe / Colour
50805	28 x 16	8	
50806	28 x 16	8	
50808	28 x 16	8	
50807	28 x 16	8	

	cm	↑ cm	Farbe / Colour
50823	40 x 16	8	



Korb, oval „PROFI LINE“

basket, oval
cesta oval
corbeille ovale



	cm	↑ cm	Farbe / Colour
50800	25 x 19	6,5	
50801	25 x 19	6,5	
50803	25 x 19	6,5	
50802	25 x 19	6,5	

	cm	↑ cm	Farbe / Colour
50815	32 x 23	7	
50817	32 x 23	7	



Korb, rund „PROFI LINE“

basket, round
cesta redonda
corbeille ronde



	Ø cm	↑ cm	Farbe / Colour
50600	16	8	
50601	16	8	
50603	16	8	
50602	16	8	

	Ø cm	↑ cm	Farbe / Colour
50605	20	8	
50606	20	8	
50608	20	8	
50607	20	8	

	Ø cm	↑ cm	Farbe / Colour
50612	29	7	



Korb, rechteckig „PROFI LINE“

basket, rectangular
cesta rectangular
corbeille rectangulaire



	cm	↑ cm	Farbe / Colour
50631	19 x 13	6	
50630	19 x 13	6	



50624

Korb, oval „PROFI LINE“

basket, oval
cesta, oval
corbeille, ovale



	cm	↑ cm	Farbe / Colour
50624	19 x 12	6	
50625	19 x 12	6	
50627	19 x 12	6	
50626	19 x 12	6	



50620

50621

50622

50623

Korb, rund „PROFI LINE“

basket, round
cesta, redonda
corbeille, ronde



	Ø cm	↑ cm	Farbe / Colour
50620	13	10	
50621	13	10	
50623	13	10	
50622	13	10	



Auslage Tablett flach „PROFI LINE“

display tray flat, baker size
bandeja de presentación, tamaño panadería
plateau de présentation, dimensions „boul-pâte“



	cm	↑ cm	Farbe / Colour
40296	40 x 30	1	
40297	60 x 40	1	



Eierkorb „PROFI LINE“

egg basket
cesta de huevos
panier à oeufs



mit Edelstahldraht im Rand, für ca. 20 Eier, hält den Inhalt durch das Stofffutter lange warm
with stainless steel wire in the rim, for around 20 eggs, keeps the eggs warm thanks to the fabric lining
con alambre de acero inoxidable en el borde, para unos 20 huevos, mantiene los huevos calientes gracias al forro de tela
avec un fil d'acier inox dans la jante, pour env. 20 oeufs, garde les oeufs au chaud grâce à la doublure en tissu

	Ø cm	↑ cm	Farbe / Colour
40299	26	17	



Eierkorb

egg basket
cesta de huevos
panier à oeufs



stabile Vollweide, für ca. 20 Eier, hält den Inhalt durch das Stofffutter lange warm
stable willow, for around 20 eggs, keeps the eggs warm thanks to the fabric lining
saule de estable, para unos 20 huevos, mantiene los huevos calientes gracias al forro de tela
saule stable, pour env. 20 oeufs, garde les oeufs au chaud grâce à la doublure en tissu

	Ø cm	↑ cm	Farbe / Colour
30299	26	17	

GN LINE



2 Höhen - 6,5 und 10 cm
2 heights - 6,5 and 10 cm



40293
GN 1/1 - 10 cm



40292
GN 1/2 - 10 cm

40225
GN 1/4 - 6,5 cm

Korb „GN LINE“

GN basket

GN cesta

GN corbeille



stabile Ausführung mit Edelstahldraht im Rand zur Stabilisierung

very solid with stainless steel wire frame to stabilize the basket

muy resistente con refuerzo de alambre inox

très résistante avec son fil de renfort inox

	cm	↑ cm	GN	Farbe / Colour
40291	53,0 x 32,5	6,5	1/1	
40290	32,5 x 26,5	6,5	1/2	
40223	32,5 x 17,6	6,5	1/3	
40225	26,5 x 16,2	6,5	1/4	
40227	17,6 x 16,2	6,5	1/6	
40229	32,5 x 35,4	6,5	2/3	

	cm	↑ cm	GN	Farbe / Colour
40293	53,0 x 32,5	10,0	1/1	
40292	32,5 x 26,5	10,0	1/2	
40243	32,5 x 17,6	10,0	1/3	
40245	26,5 x 16,2	10,0	1/4	
40247	17,6 x 16,2	10,0	1/6	
40249	32,5 x 35,4	10,0	2/3	



GN 1/1

GN 1/1 Besteckbehälter

GN 1/1 dispenser GN

GN 1/1 dispensador de cubiertos

GN 1/1 bac à couverts



4 Mulden, Kunststoff-Geflecht, Drahtgestell, braun-schwarz

4 compartments, with reinforced chromed wire structure, brown-black

4 compartimentos, de plástico, con bastidor cromado reforzado, marrón oscuro

4 compartiments, en plastique, cadre acier chromé renforcé, couleur marron foncé

	cm	↑ cm	GN	Farbe / Colour
11966	53 x 32,5	9	1/1	

GN LINE



2 Höhen - 6,5 und 10 cm
2 heights - 6,5 and 10 cm



40220 GN 1/1



40222 GN 1/2



40228 GN 1/6



40264 GN 1/4

40272 GN 1/2

Korb „GN LINE“

GN basket
GN cesta
GN corbeille



stabile Ausführung mit Edelstahldraht im Rand zur Stabilisierung

very solid with stainless steel wire frame to stabilize the basket

muy resistente con refuerzo de alambre inox

très résistante avec son fil de renfort inox

	cm	↑ cm	GN	Farbe / Colour
40220	53,0 x 32,5	6,5	1/1	Yellow
40222	32,5 x 26,5	6,5	1/2	Yellow
40224	32,5 x 17,6	6,5	1/3	Yellow
40226	26,5 x 16,2	6,5	1/4	Yellow
40228	17,6 x 16,2	6,5	1/6	Yellow
40230	32,5 x 35,4	6,5	2/3	Yellow
	cm	↑ cm	GN	Farbe / Colour
40240	53,0 x 32,5	10	1/1	Yellow
40242	32,5 x 26,5	10	1/2	Yellow
40244	32,5 x 17,6	10	1/3	Yellow
40246	26,5 x 16,2	10	1/4	Yellow
	cm	↑ cm	GN	Farbe / Colour
40260	53,0 x 32,5	6,5	1/1	Brown
40262	32,5 x 26,5	6,5	1/2	Brown
40263	32,5 x 17,6	6,5	1/3	Brown
40264	26,5 x 16,2	6,5	1/4	Brown
	cm	↑ cm	GN	Farbe / Colour
40270	53,0 x 32,5	10	1/1	Brown
40272	32,5 x 26,5	10	1/2	Brown
40274	32,5 x 17,6	10	1/3	Brown
40276	26,5 x 16,2	10	1/4	Brown

ECONOMIC



Tisch- und Buffetkorb „ECONOMIC“
buffet basket
cesta de buffet
corbeille de buffet



	Ø cm	↑ cm	Farbe / Colour
40132	19,0	9,5	Yellow
40135	25,5	8,5	Yellow
40144	39,0	10,0	Yellow
40191	19,0	9,5	Brown
40192	25,5	8,5	Brown

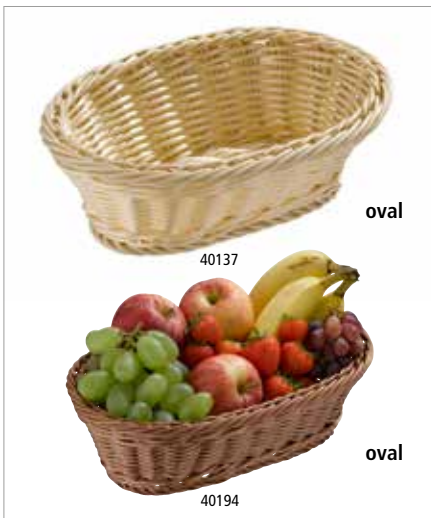

Tisch- und Buffetkorb „ECONOMIC“
buffet basket
cesta de buffet
corbeille de buffet



	cm	↑ cm	Farbe / Colour
40137	23,0 x 17	8,0	Yellow
40139	28,5 x 17	8,5	Yellow
40193	23,0 x 17	8,0	Brown
40194	28,5 x 17	8,5	Brown



stapelbar
stackable



Tisch- und Buffetkorb „ECONOMIC“
buffet basket
cesta de buffet
corbeille de buffet



	cm	↑ cm	Farbe / Colour
40140	23,0 x 17	8	Yellow
40159	31,5 x 22	8,5	Yellow
40195	23,0 x 17	8	Brown
40196	31,5 x 22	8,5	Brown



GN Buffetkorb „ECONOMIC“
GN basket
GN cesta
GN corbeille



	cm	↑ cm	GN	Farbe / Colour
40148	53 x 32,5	8	1/1	Yellow



GN Buffetkorb „ECONOMIC“
GN basket
GN cesta
GN corbeille



	cm	↑ cm	GN	Farbe / Colour
40152	32,5 x 26,5	8	1/2	Yellow

**Buffetkorb „ECONOMIC“**

buffet basket
cesta de buffet
corbeille de buffet



stabile Ausführung mit Edelstahldraht im Rand zur Stabilisierung

very solid with stainless steel wire frame to stabilize the basket

muy resistente con refuerzo de alambre inox

très résistante avec son fil de renfort inox

	cm	↑ cm
40153	45 x 42	17 / 24



40149

Buffetkorb, rund „ECONOMIC“

buffet basket, round
cesta de buffet, redonda
corbeille de buffet ronde



stabile Ausführung mit Edelstahldraht im Rand zur Stabilisierung

very solid with stainless steel wire frame to stabilize the basket

muy resistente con refuerzo de alambre inox

très résistante avec son fil de renfort inox

	Ø cm	↑ cm	Farbe / Colour
40149	40	12,5	
40295	40	12,5	



18389

Rolltophaube mit verchromtem Kugelgriff / rolltop cover with chrome plated handle / campana abatible con pomo cromado / cloche basculante avec bouton chromé

	Ø cm	↑ cm
18388	38	20

Rolltophaube mit vergoldetem Kugelgriff / rolltop cover with gold plated handle / campana abatible con pomo dorado / cloche basculante avec bouton doré

	Ø cm	↑ cm
18387	38	20

Rolltophaube mit verchromtem Designergriff / rolltop cover with chrome plated designer handle / campana abatible con pomo de diseño cromado / cloche basculante avec bouton design chromé

	Ø cm	↑ cm
18389	38	20



11010

Buffetkorb „ECONOMIC“

buffet basket
cesta de buffet
corbeille buffet



stabile Ausführung, Edelstahl Fixierungsrahmen, zur Rutschsicherung, ohne Haube

stainless steel fix the cover, without cover

con marco cromado patentado para fijar y encajar la campana (se entrega sin la campana)

cadre fil acier inoxydable pour fixer la cloche (livré sans la cloche)

	cm	↑ cm	Farbe / Colour
40150	56,5 x 36	10	
40294	56,5 x 36	10	



11018

GN 1/1 Rolltop-Haube / GN 1/1 rolltop cover / GN 1/1 campana abatible / GN 1/1 cloche basculante

	cm	↑ cm	GN	
11008	53 x 32,5	19	1/1	vergoldeter Griff / gold plated handle pomo dorado / bouton doré
11010	53 x 32,5	19	1/1	verchromter Griff / chrome plated handle pomo cromado / bouton chromé
11018	53 x 32,5	17	1/1	mit verchromtem Designergriff with chrome plated designer handle

ECONOMIC



Buffetgestell „DOPPELDECKER“ für GN

buffet frame for GN
estructura para buffet para GN
support buffet pour GN



2-teilig, einfach zusammensetzbar, Etagen-Abstand 26 cm, platzsparend, stabile Ausführung

2 pcs., easy to assemble, distance between the tiers 26 cm, space-saving, robust

2 pzas, fácil de montar, distancia entre pisos 26 cm, robusto

2 pcs, assemblage facile, distance entre niveaux 26 cm, robuste

	cm	↑ cm	fits to GN
11555	50 x 34	37,5	1/1



GN Kuppelhaube

GN cover
GN cúpula
GN cloche bombée



glasklarer Kunststoff, Griff aus Zinkdruckguss

crystal clear plastic, die-cast zinc knob

plástico transparente, asa de zinc fundido a presión

plastique transparente, poignée en zinc moulé sous pression

	cm	↑ cm	GN	
11026	54 x 33	20	1/1	geschlossen / totally closed cerrada / totalmente fermée
11027	54 x 33	20	1/1	mit Front-Ausschnitt / one long side cut out gran apertura frontal / grande ouverture frontale
11028	54 x 33	20	1/1	mit seitlichem Ausschnitt / one small side cut out / pequeña apertura lateral / petite ouverture latérale



GN Kuppelhaube

GN cover
GN cúpula
GN cloche bombée



glasklarer Kunststoff, Griff aus Zinkdruckguss

crystal clear plastic, die-cast zinc knob

plástico transparente, asa de zinc fundido a presión

plastique transparente, poignée en zinc moulé sous pression

	cm	↑ cm	GN	
11070	54 x 33	20	1/1	geschlossen / totally closed cerrada / totalmente fermée
11071	54 x 33	20	1/1	mit Front-Ausschnitt / one long side cut out gran apertura frontal / grande ouverture frontale
11072	54 x 33	20	1/1	mit seitlichem Ausschnitt / one small side cut out / pequeña apertura lateral / petite ouverture latérale



Baguettekorb „ECONOMIC“

baguette basket
cesta para baguette
corbeille pour baguettes



stabile Ausführung mit Edelstahl draht im Rand zur Stabilisierung

very solid with stainless steel wire frame to stabilize the basket

muy resistente con refuerzo de alambre inox

très résistante avec son fil de renfort inox

	Ø cm	↑ cm	Farbe / Colour
40198	35	24 / 42	



Besteckkorb „ECONOMIC“

cutlery dispenser
dispensador de cubiertos
corbeille à couverts



4 Fächer (3 kleine und 1 großes) / 4 compartments (3 small and 1 large) /
4 compartimentos (3 pequeños y 1 grande) / 4 compartiments (3 petits et 1 grand)

	cm	↑ cm	Farbe / Colour
40179	26 x 18	15	
40182	26 x 18	15	



Besteckkorb „ECONOMIC“

cutlery dispenser
dispensador de cubiertos
corbeille à couverts



	Ø cm	↑ cm	Farbe / Colour
40130	12	15	
40007	12	15	
40012	12	15	
40013	12	15	



Besteckkorb „ECONOMIC“

cutlery dispenser
dispensador de cubiertos
corbeille à couverts



	cm	↑ cm	Farbe / Colour
40131	27 x 10	4,5	
40009	27 x 10	4,5	
40010	27 x 10	4,5	
40011	27 x 10	4,5	

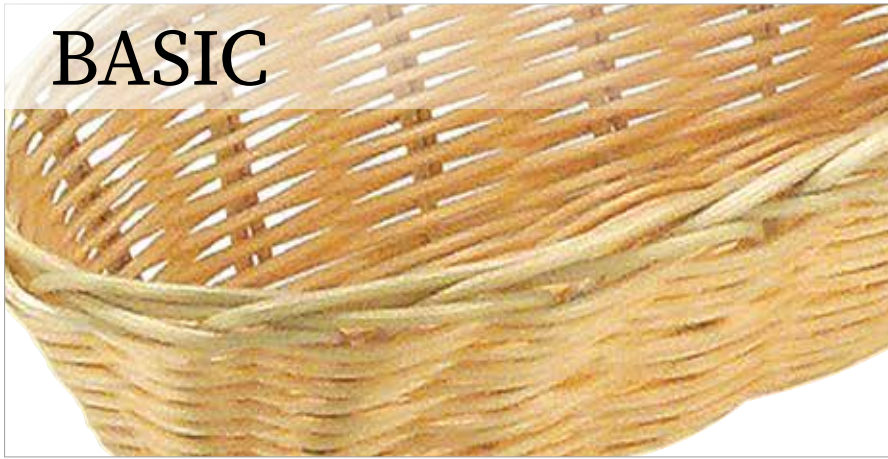

BASIC

- in Handarbeit geflochten
- einfache und leichte Ausführung

- wickerwork
- simple and light version

- ligera
- trensada a mano

- tressé à main
- version légère



oval

Brot- und Obstkorb „BASIC“
 basket for bread or fruits
 cesta para pan o fruta
 corbeille à pain ou à fruits



	cm	↑ cm
30279	18 x 12	7
30280	23 x 15	6



oval

Brot- und Obstkorb „BASIC“
 basket for bread or fruits
 cesta para pan o fruta
 corbeille à pain ou à fruits



	cm	↑ cm
30282	21 x 10	6



rund

Brot- und Obstkorb „BASIC“
 basket for bread or fruits
 cesta para pan o fruta
 corbeille à pain ou à fruits



	Ø cm	↑ cm
30281	20	7
30285	25	7



rechteckig

Tisch- und Buffetkorb „BASIC“
 buffet basket
 cesta de buffet
 corbeille de buffet



	cm	↑ cm
30286	30 x 22	7
30283	22 x 15	6



Brot- und Obstkorb „WICKER LOOK“

basket for bread or fruits
cesta para pan o fruta
corbeille à pain ou à fruits



	cm	↑ cm	Farbe / Colour
40214	Ø 20	6,5	■
40216	23 x 17	6,5	■
	cm	↑ cm	Farbe / Colour
40212	39,5 x 29,5	10	■



GN 1/1 Korb „SUPERSTRONG“

GN 1/1 basket
GN 1/1 cesta
GN 1/1 corbeille



	cm	↑ cm	GN	Farbe / Colour
50644	53 x 32,5	10,0	1/1	■

GN Kuppelhaube / GN cover / GN cúpula / GN cloche bombée

	cm	↑ cm	GN
11027	54 x 33	20	1/1



passend zu Regalwagen 71441, S. 365
suitable for trolley 71441, S. 365



GN Kuppelhaube

GN cover
GN cúpula
GN cloche bombée

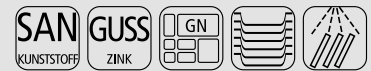

glasklarer Kunststoff, Griff aus Zinkdruckguss

crystal clear plastic, die-cast zinc knob

plástico transparente, asa de zinc fundido a presión

plastique transparente, poignée en zinc moulé sous pression

	cm	↑ cm	GN	
11070	54 x 33	20	1/1	geschlossen / totally closed cerrada / totalmente fermée
11071	54 x 33	20	1/1	mit Front-Ausschnitt / one long side cut out gran apertura frontal / grande ouverture frontale
11072	54 x 33	20	1/1	mit seitlichem Ausschnitt / one small side cut out / pequeña apertura lateral / petite ouverture latérale



GN Abdeckhaube

GN cover
GN cubierta
GN cloche



passend für GN 1/1 Körbe, glasklarer Kunststoff, nahezu bruchfest

suitable for GN 1/1 baskets, clear plastic, nearly unbreakable

apto para cestas GN 1/1, plástico transparente, muy resistente a la rotura

pour bacs et corbeilles GN 1/1, plastique transparent, très résistant à la casse

	cm	↑ cm	mm	GN
11042	53,0 x 32,5	9,5	3	1/1

BREAD BASKETS



Umgekrempelt kann die Höhe individuell gestaltet werden!
Adjustable height by turning the edge upside down!
Altura ajustable girando el borde al revés!
Hauteur ajustable en tournant le bord à l'envers!



Brottasche
bread basket
panera
corbeille



eckig, 70% Naturfaser und 30% Kunstharz
angular, 70% natural fibre and 30% synthetic resin
ángulo, 70% fibra natural y 30% resina sintética
carré, 70% de fibres naturelles et 30% de résine synthétique

	cm	↑ cm	Farbe / Colour
30355	12 x 11,5	11,5	■
30356	12 x 11,5	11,5	■

rund, 70% Naturfaser und 30% Kunstharz
round, 70% natural fibre and 30% synthetic resin
redondo, 70% fibra natural y 30% resina sintética
ronde, 70% de fibres naturelles et 30% de résine synthétique

	Ø cm	↑ cm	Farbe / Colour
30440	17	11	■
30450	20	13	■
30442	24	24	■
30443	30	22	■
30441	17	11	■
30451	20	13	■
30445	24	24	■
30446	30	22	■



Brottasche
bread basket
panera
corbeille



rund, schmutzabweisende Kunstfaser, 30°C waschbar, wendbar
round, dirt-repellent synthetic fibre, washable 30°C, reversible
redondo, fibra sintética repelente a la suciedad, lavable a 30°C, reversible
ronde, fibre synthétique anti-salissante, lavable à 30°C, réversible

	Ø cm	↑ cm	Farbe / Colour
30345	17	11,5	■ ■
30346	20	13,5	■ ■



Brottasche
bread basket
panera
corbeille



rechteckig, schmutzabweisende Kunstfaser, 30°C waschbar, wendbar
rectangular, dirt-repellent synthetic fibre, washable 30°C, reversible
rectangular, fibra sintética repelente a la suciedad, lavable a 30°C, reversible
rectangulaire, fibre synthétique anti-salissante, lavable à 30°C, réversible

	cm	↑ cm	Farbe / Colour
30347	19 x 11	10,5	■ ■
30348	24 x 16	10,5	■ ■



Präsentationsmöglichkeit
presentation example



Brottasche
bread basket
panera
corbeille à pain en toile



Baumwolle, umgekrempelt kann die Höhe individuell gestaltet werden, maschinenwaschbar bis 30°C
cotton, adjustable height by turning the edge upside down, machine-washable 30°C
walgodón, altura ajustable girando el borde al revés, lavable a máquina 30°C
coton, hauteur ajustable en tournant le bord à l'envers, lavable en machine maxi 30°C

	Ø cm	↑ cm	Farbe / Colour
30340	17	11	■ ■
30350	20	12	■ ■
30341	17	11	■ ■
30351	20	12	■ ■

	cm	↑ cm	Farbe / Colour
30360	20 x 15	10	■ ■
30370	25 x 18	12	■ ■
30361	20 x 15	10	■ ■
30371	25 x 18	12	■ ■

BREAD BASKETS



Brottasche mit Wärmekissen

bread basket with stones pillow

panera con cojin

corbeille à pain en toile avec coussin chauffant



Baumwolle, Keramik-Kugeln, maschinenwaschbar bis 30°C, mit Zugverschluss, Wärmekissen kann einfach in der Mikrowelle erhitzt werden (90 Sekunden / 500 Watt)

cotton, ceramic balls, machine washable up to 30°C, with drawstring closure, heat pad can easily be heated in the microwave (90 seconds / 500 watts)

algodón, bolas de cerámica, lavable a máquina hasta 30°C, con cierre de cordón, la almohadilla térmica se puede calentar fácilmente en el microondas (90 segundos / 500 vatios)

coton, billes en céramique, lavable en machine jusqu'à 30°C, avec fermeture à tirette, le coussin chauffant peut être facilement chauffé au micro-ondes (90 secondes / 500 watts)

	Ø cm	↑ cm	Farbe / Colour
30380	19	23	
30390	19	23	

Wärmekissen / stones pillow / cojín de piedrecillas a calentar / coussin de petites pierres, à chauffer

	Ø cm	↑ cm
30385	19	1,5



Häkelkorb

crochet rope basket

cesta de ganchillo

panier au crochet

umgekrepelt kann die Höhe individuell eingestellt werden

adjustable height by turning the edge upside down

altura ajustable girando el borde al revés

hauteur ajustable en tournant le bord à l'envers



	cm	↑ cm
30395	20 x 13,5	10
30396	24 x 17,5	12



Präsentationsmöglichkeit
presentation example

NEW



Brot- und Obstkorb
basket for bread or fruits
cesta para pan o fruta
corbeille à pain ou à fruits



inklusive Tasche aus Baumwolle, beige grau, maschinenwaschbar bis 30 Grad
incl. bag made of cotton, beige, grey, machine washable up to 30°C
bolsa incluida, de algodón, beige, gris, lavable a máquina hasta 30°C
sac inclus en coton, beige, gris, lavable en machine jusqu'à 30°C

	Ø cm	↑ cm
30209	27,5	18,5



stapelbar
stackable

rutschfest inklusive Klipp
non-slip, includes clip



40690 0,7 ltr.



40691 0,7 ltr.



40692 0,7 ltr.

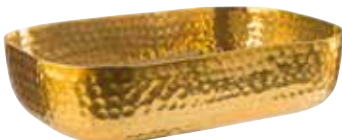

40693 1,4 ltr.



40694 1,4 ltr.



40695 1,4 ltr.

Schale
bowl
cuenco
bol



gehämmerte Oberfläche
hammered surface
superficie martillada
surface martelée

	Ø cm	↑ cm	ltr.	Farbe / Colour
40690	15,5 x 12,0	5,5	0,7	gold look
40691	15,5 x 12,0	5,5	0,7	copper look
40692	15,5 x 12,0	5,5	0,7	gunmetal look
40693	23,0 x 15,5	6,0	1,4	gold look
40694	23,0 x 15,5	6,0	1,4	copper look
40695	23,0 x 15,5	6,0	1,4	gunmetal look



Präsentationsmöglichkeit
presentation example





NEW SVART



Korb „SVART“
basket
cesta
corbeille

Farbe: whisper white / colour: whisper white / color: blanco crema / couleur: blanc-crème



METALL   

	Ø cm	↑ cm	Farbe / Colour
30425	17,5	8	<input type="text"/>
30426	20	8	<input type="text"/>



Korb „SVART“
basket
cesta
corbeille

Farbe: whisper white / colour: whisper white / color: blanco crema / couleur: blanc-crème

METALL   

	cm	↑ cm	Farbe / Colour
30427	20 x 15	8	<input type="text"/>
30428	24 x 19	8	<input type="text"/>



Korb „SVART“
basket
cesta
corbeille

Farbe: whisper white / colour: whisper white / color: blanco crema / couleur: blanc-crème

METALL   

	cm	↑ cm	Farbe / Colour
30429	29,5 x 25,5	13,5	<input type="text"/>

NEW SVART



Korb „SVART“

basket
cesta
corbeille



Farbe: dream blue / colour: dream blue / color: azul / couleur: bleu

	Ø cm	↑ cm	Farbe / Colour
30452	17,5	8	
30453	20	8	



Korb „SVART“

basket
cesta
corbeille



Farbe: dream blue / colour: dream blue / color: azul / couleur: bleu

	cm	↑ cm	Farbe / Colour
30454	20 x 15	8	
30455	24 x 19	8	

NEW

SVART



NEW



30470



30471

Korb „SVART“

basket
cesta
corbeille



Farbe: smoke green / colour: smoke green / color: verde oscuro / couleur: vert foncé

	Ø cm	↑ cm	Farbe / Colour
30470	17,5	8	
30471	20	8	

NEW



30472



30473

Korb „SVART“

basket
cesta
corbeille



Farbe: smoke green / colour: smoke green / color: verde oscuro / couleur: vert foncé

	cm	↑ cm	Farbe / Colour
30472	20 x 15	8	
30473	24 x 19	8	

SVART



Korb „SVART“

basket
cesta
corbeille



	cm	↑ cm	Farbe / Colour
30424	29,5 x 25,5	13,5	■



Korb „SVART“

basket
cesta
corbeille



	cm	↑ cm	Farbe / Colour
30422	20 x 15	8	■
30423	24 x 19	8	■



Korb „SVART“

basket
cesta
corbeille



	Ø cm	↑ cm	Farbe / Colour
30420	17,5	8	■
30421	20,0	8	■



URBAN



GN Korb „URBAN“

GN basket
GN cesta
GN corbeille



	cm	↑ cm	GN	Farbe / Colour
30414	53,0 x 32,5	7,5	1/1	■
30415	32,5 x 26,5	7,5	1/2	■
30416	53,0 x 16,2	7,5	2/4	■
30417 <small>NEW</small>	32,5 x 17,6	7,5	1/3	■
30418 <small>NEW</small>	26,5 x 16,2	7,5	1/4	■



Korb „URBAN“

basket
cesta
corbeille



	Ø cm	↑ cm	Farbe / Colour
30410	17	7,0	■
30411	20	8,5	■



Korb „URBAN“
basket
cesta
corbeille



	cm	↑ cm	Farbe / Colour
30337	29 x 16	7	■



Korb „URBAN“
basket
cesta
corbeille



	cm	↑ cm	Farbe / Colour
30412	21 x 10	7	■
30413	30 x 14	12	■



GN Abdeckhaube
GN cover
GN cubierta
GN cloche

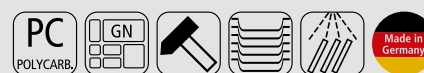

	cm	↑ cm	* mm	GN
11041	32,5 x 26,5	9,5	3	1/2
11042	53,0 x 32,5	9,5	3	1/1
11043	32,5 x 17,6	10,5	3	1/3
11044	53,0 x 16,2	10,5	3	2/4



GN Kuppelhaube
GN cover
GN cúpula
GN cloche bombée



glasklarer Kunststoff, Griff aus Zinkdruckguss
crystal clear plastic, die-cast zinc knob
plástico transparente, asa de zinc fundido a presión
plastique transparente, poignée en zinc moulé sous pression

	cm	↑ cm	GN	
11070	54 x 33	20	1/1	geschlossen / totally closed cerrada / totalmente fermée
11071	54 x 33	20	1/1	mit Front-Ausschnitt / one long side cut out gran apertura frontal grande ouverture frontale
11072	54 x 33	20	1/1	mit seitlichem Ausschnitt one small side cut out pequeña apertura lateral petite ouverture latérale
11073	33 x 28	17	1/2	geschlossen / totally closed cerrada / totalement fermée
11074	33 x 28	17	1/2	mit Front-Ausschnitt / one long side cut out gran apertura frontal grande ouverture frontale





NEW

URBAN



GN Korb „URBAN“

GN basket
GN cesta
GN corbeille



Farbe: whisper white / colour: whisper white / color: blanco crema / couleur: blanc-crème

	cm	↑ cm	GN	Farbe / Colour
30435	53 x 32,5	7,5	1/1	<input type="checkbox"/>
30436	32,5 x 26,5	7,5	1/2	<input type="checkbox"/>
30439	53 x 16,2	7,5	2/4	<input type="checkbox"/>
30437	32,5 x 17,6	7,5	1/3	<input type="checkbox"/>
30438	26,5 x 16,2	7,5	1/4	<input type="checkbox"/>



Korb „URBAN“

basket
cesta
corbeille



Farbe: whisper white / colour: whisper white / color: blanco crema / couleur: blanc-crème

	Ø cm	↑ cm	Farbe / Colour
30430	17	7	<input type="checkbox"/>
30431	20	8,5	<input type="checkbox"/>



Besteckbehälter / Korb
 cutlery bin / basket
 porta cubiertos / cesta
 range-couverts / corbeille
matt poliert, Boden: 29 x 8,5 cm
 matt polished, base: 29 x 8,5 cm
 pulido mate, base: 29 x 8,5 cm
 poli mat, fond: 29 x 8,5 cm



	cm	↑ cm	ltr.	Farbe / Colour
11752	29,5 x 12	10	2	



Präsentationsmöglichkeit
 presentation example



Besteckbehälter / Korb
 cutlery bin / basket
 porta cubiertos / cesta
 range-couverts / corbeille
Boden: 29 x 8,5 cm
 base: 29 x 8,5 cm
 base: 29 x 8,5 cm
 fond: 29 x 8,5 cm



	cm	↑ cm	ltr.	Farbe / Colour
11753	29,5 x 12	10	2	



Präsentationsmöglichkeit
 presentation example

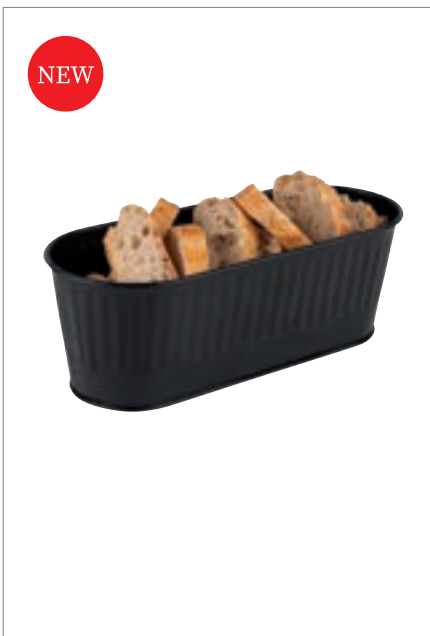

Besteckbehälter / Korb
 cutlery bin / basket
 porta cubiertos / cesta
 range-couverts / corbeille
Boden: 29 x 8,5 cm
 base: 29 x 8,5 cm
 base: 29 x 8,5 cm
 fond: 29 x 8,5 cm



	cm	↑ cm	ltr.	Farbe / Colour
11754	29,5 x 12	10	2	



Präsentationsmöglichkeit
 presentation example

STAINLESS STEEL BASKETS

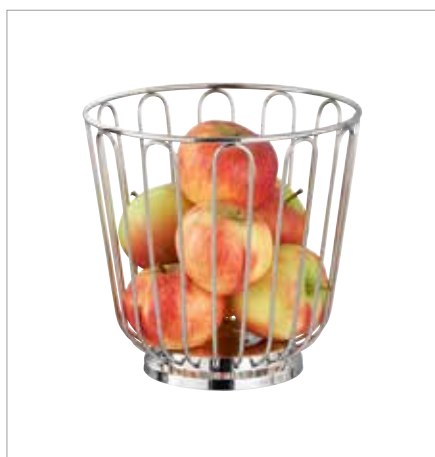

Obstkorb
 basket for fruits
 cesta para fruta
 corbeille à fruits
hochglanzpoliert
 mirror polished finish
 acabado pulido brillante
 brillant



	Ø cm	↑ cm
30270	21,5	20,5

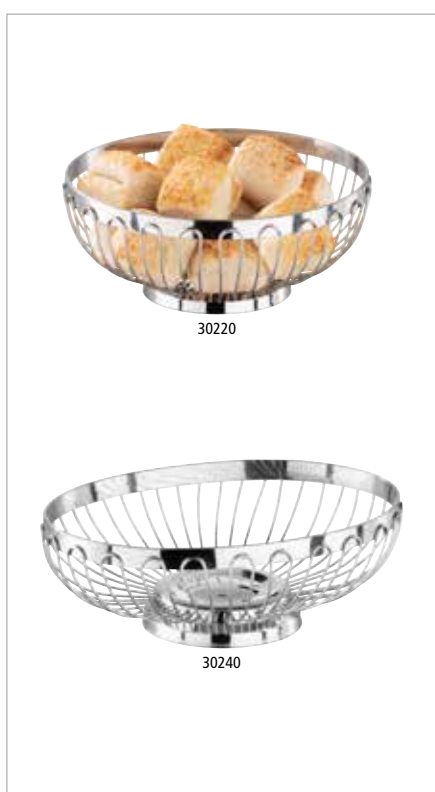

Brot- und Obstkorb
 basket for bread or fruits
 cesta para pan o fruta
 corbeille à pain ou à fruits
hochglanzpoliert, rund
 mirror polished finish, round
 acabado pulido brillante, redondo
 brillant, rond



	Ø cm	↑ cm
30200	17,5	7,0
30220	20,5	8,5
30230	25,5	9,5

oval / oval / oval / oval

	cm	↑ cm
30210	20 x 15	7,0
30240	24 x 19	8,5
30250	28 x 21	9,5

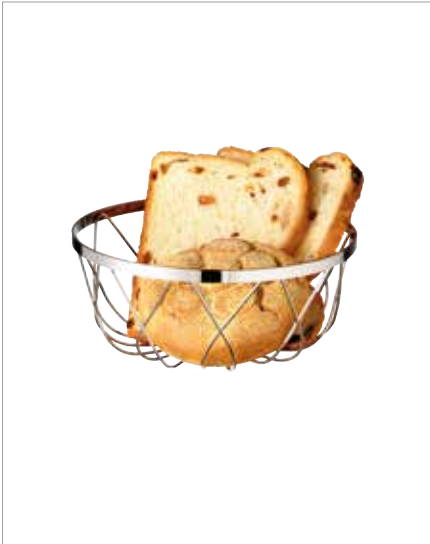

Brot- und Obstkorb
 basket for bread or fruits
 cesta para pan o fruta
 corbeille à pain ou fruits



	Ø cm	↑ cm
30310	18	7,5



30276



30277

Brot- und Obstschale
 bowl for bread or fruits
 bol para pan o fruta
 bol à pain ou à fruits



hochglanzpoliert, Hammerschlag Optik
 mirror polished finish, hammered look
 acabado pulido efecto espejo, aspecto repujado
 brillant, aspect martelé

	Ø cm	↑ cm
30276	16	5,0
30277	20	5,5

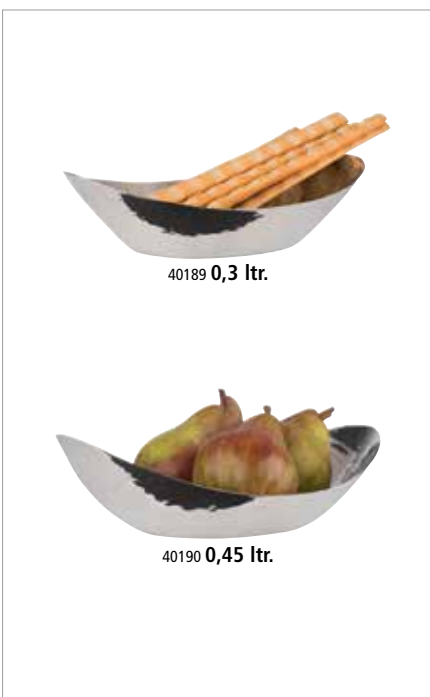

40189 0,3 ltr.



40190 0,45 ltr.

Schale
 bowl
 cuenco
 bol



gehämmerte Oberfläche
 hammered surface
 superficie martillada
 surface martelée

	cm	↑ cm	ltr.
40189	20 x 13,5	5,5	0,30
40190	24 x 16,5	7,0	0,45



BASKETS

NEW



Brot- und Obstkorb

basket for bread or fruits
cesta para pan o fruta
corbeille à pain ou à fruits



inklusive Tasche aus Baumwolle, beige grau, maschinenwaschbar bis 30 Grad
incl. bag made of cotton, beige, grey, machine washable up to 30°C
bolsa incluida, de algodón, beige, gris, lavable a máquina hasta 30°C
sac inclus en coton, beige, gris, lavable en machine jusqu'à 30°C

	Ø cm	↑ cm
30209	27,5	18,5



stapelbar
stackable

rutschfest inklusive Klipp
non-slip, includes clip



30208

Brot- und Obstkorb

basket for bread or fruits
cesta para pan o fruta
corbeille à pain ou fruits



	Ø cm	↑ cm	Farbe / Colour
30207	21	16,5	copper-look handle
30208	30	19,0	copper-look handle

Brot- und Obstkorb „WIRE“

wire basket
cesta para pan o fruta
corbeille pour pain ou fruits



	Ø cm	↑ cm	Farbe / Colour
30206	31	14	metal black



BASKETS / RISERS



Korb / Ständer „APS PLUS“

basket / riser
cesta / soporte
corbeille / support



	Ø cm	↑ cm	Farbe / Colour
15320	10,5 / 8	8	polished chrome
15324	10,5 / 8	8	brushed gold
15322	10,5 / 8	8	brushed copper



Korb / Ständer „APS PLUS“

basket / riser
cesta / soporte
corbeille / support



	Ø cm	↑ cm	Farbe / Colour
15336 <small>NEW</small>	15	10,5	black
15337 <small>NEW</small>	21	20,0	black
15331	15	10,5	polished chrome
15332	21	20,0	polished chrome
15334	15	10,5	brushed gold
15335	21	20,0	brushed gold



Präsentationsmöglichkeit
presentation example



Korb / Ständer „APS PLUS“

basket / riser
cesta / soporte
corbeille / support



	Ø cm	↑ cm	Farbe / Colour
15326	21 / 15	21	black



SUPERBOX

00973
Schieferplatte
GN 2/4

11621
Box GN 1/2

11620
Box GN 1/1

Die stapelbaren Wendeboxen lassen sich rutschfest stapeln und mit flachen GN Platten verbinden und einzeln nutzen. Individuell können Buffet-landschaften gebaut werden.

The stackable and non-slip reversible boxes can be connected to flat GN trays and can also be used individually. Different and individual buffet sceneries can be built up.

Las cajas girables y apilables son antideslizantes y se pueden conectar con bandejas planas GN o utilizar individualmente. Se pueden construir diferentes paisajes de buffet muy individuales.

Les boîtes de tournage empilables sont antiglissantes et peuvent être connectées avec des plateaux plats GN ou utilisées individuellement. Des paysages de buffet très personnalisés peuvent être construits.



NEW

2 tlg.
2 pcs.

11719

Beschriftungsschilder, 2er Set
inscription labels, 2 pcs.
étiquettes d'inscription, set de 2
etiquetas de inscripción, set de 2



	cm	↑ cm	Farbe / Colour
11719	8 x 1,5	5,5	■



Kreide-Marker, Stärke 2 mm, 2er Set
chalk marker, 2 pcs.
rotulador de tiza, set de 2
marqueur a la craie liquide, set de 2



	Ø cm	↑ cm	Farbe / Colour	pcs.
71490	1	13	■	2



11626

11721

GN 1/1 „SUPERBOX“



Akazienholz / acacia wood / madera de acacia / bois d'acacia

	cm	↑ cm	GN	Farbe / Colour
11620	55,5 x 35,0	10,5	1/1	■
11626	55,5 x 35,0	10,5	1/1	■
11721	55,5 x 35,0	20,0	1/1	■
11723	55,5 x 35,0	20,0	1/1	■



GN 2/4 „SUPERBOX“

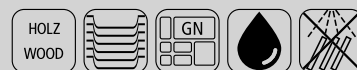

Akazienholz / acacia wood / mader de acacia / bois d'acacia

	cm	↑ cm	Farbe / Colour
11623	55,5 x 18,5	10,5	
11629	55,5 x 18,5	10,5	



GN 1/2 „SUPERBOX“

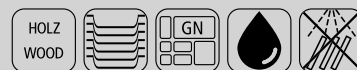

Akazienholz / acacia wood / mader de acacia / bois d'acacia

	cm	↑ cm	GN	Farbe / Colour
11621	35,0 x 29,0	10,5	1/2	
11627	35,0 x 29,0	10,5	1/2	
11722	35,0 x 29,0	20,0	1/2	
11724	35,0 x 29,0	20,0	1/2	



GN 1/4 „SUPERBOX“



Akazienholz / acacia wood / mader de acacia / bois d'acacia

	cm	↑ cm	Farbe / Colour
11622	29 x 18,5	10,5	
11628	29 x 18,5	10,5	



Buffetgestell

buffet stand
soporte para buffet
présentoir buffet



Metall, schwarz, passend für GN Boxen, mit Antrutschfüßchen

metal, black, suitable for GN boxes, with non-slip feet

metal, negro, para cajas GN, con pies antideslizantes

métal, noir, pour boîtes GN, avec pieds antidérapantsw

	cm	↑ cm	suitable for	Farbe / Colour
30329 <small>NEW</small>	29 x 32,5	48	GN 1/2 boxes	
30331	49 x 38,5	48	GN 1/1, GN 1/2 boxes	



Präsentationsmöglichkeit
presentation example





Chafing Dish, GN Container & Transport

PREMIUM	390
GLOBE	392
EASY INDUCTION	396
CHAFING DISHES	398
ELECTRIC CHAFING DISHES	400
SOUP WARMERS	401
INDUCTION STATION	403
INDUCTION PLATES HEATING UNITS	404
CHAFING DISHES ACCESSORIES	405
THERMAL BRIDGE WARMERS	406
5 STARS	408
COFFEE AND TEADISPENSER	412
GN-CONTAINERS	414
SERVING TROLLEYS	426
CUTLERY BOXES	428
CONTAINERS EGG BOXES	432
BUCKETS FUNNELS	433

PREMIUM



langlebige Deckelbremse
Abnehmbarer Deckel, dieser lässt sich spielend leicht öffnen und schließen, der Lauf des Deckels wird professionell gedämpft.

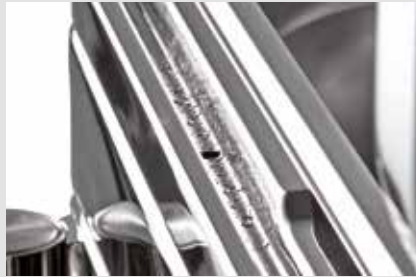

Kondenswasser - Rücklaufsystem
Kondenswasser wird in das Wasserbecken zurückgeführt.



Sandwichboden / Kapselboden
Induktionsfähiger Boden, direkt auf dem Induktionskochfeld einsetzbar. Perfekte Wärmeverteilung und Steuerung.



Fixierschraube / Rutschsicherung
Höhenverstellbares Gelenk, fixiert das Gerät in dem Gestell und auf dem Tisch.



Induktionskochplatte Nr. 12295
Induktionskochplatte wird einfach in das Gestell gelegt.



stapelbar
Chafing Dish Rahmen sind übereinander stapelbar. Platzsparend und rutschfest stapeln und transportieren.



Induktionskochplatte für Chafing Dish

induction plate for chafing dish
placa de inducción para chafing dish
plaque à induction pour chafing dish

mit Regler
with power control
con control de potencia
avec régulateur

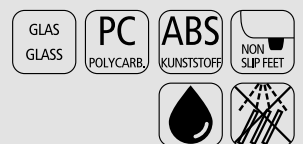

	Ø cm	
12295	24	900 W



12370

Lieferung ohne Induktionskochplatte
delivery without induction plate
se entrega sin placa de inducción
livré sans plaque à induction

GN 1/1 Chafing Dish „PREMIUM“



1 Gestell + 1 Wasserbecken mit Sandwichboden + 1 Wasserbeckenrahmen + 1 Deckel mit hydraulischem Gelenk + 1 GN 1/1 Behälter 65 mm tief, hitzebeständige Griffe, hochwertige Verarbeitung, ausschließlich für Induktionskochfelder

1 frame + 1 waterpan with sandwich base + 1 frame for waterpan + 1 hydraulic cover + 1 GN 1/1 container 65 mm, heat resistant handles, high quality, only for induction plates

1 soporte + 1 cubeta baño maría con base sandwich + 1 marco para cubeta baño maría + 1 tapa hidráulica + 1 cubeta GN 1/1 de 65 mm, asas resistentes al calor, acabado de alta calidad, solamente para inducción

1 pied support + 1 bac bain-marie avec fond sandwich + 1 cadre pour bac bain-marie + 1 couvercle hydraulique + 1 bac GN 1/1 de 65 mm, poignées résistantes à la chaleur, finition de qualité, uniquement pour induction

	cm	↑ cm	ltr.	
12370	66 x 48	33	9	mit Edelstahldeckel with stainless steel cover
12352	66 x 48	33	9	mit Glasdeckel with glass cover



12353

Lieferung ohne Induktionskochplatte
delivery without induction plate
se entrega sin placa de inducción
livré sans plaque à induction

Chafing Dish rund „PREMIUM“



1 Gestell + 1 Wasserbecken mit Sandwichboden + 1 Wasserbeckenrahmen + 1 Deckel mit hydraulischem Gelenk + 1 runder Speisenbehälter, hitzebeständiger Griff, hochwertige Verarbeitung, ausschließlich für Induktionskochfelder

1 frame + 1 waterpan with sandwich base + 1 frame for waterpan + 1 hydraulic cover + 1 round foodpan, heat resistant handle, high quality, only for induction plates

1 soporte + 1 cubeta baño maría con base sandwich + 1 marco para cubeta baño maría + 1 tapa hidráulica + 1 cubeta redonda, asa resistente al calor, acabado de alta calidad, solamente para inducción

1 pied support + 1 bac bain-marie avec fond sandwich + 1 cadre pour bac bain-marie + 1 couvercle hydraulique + 1 bac rond, poignée résistante à la chaleur, finition de qualité, uniquement pour induction

	cm	↑ cm	ltr.	
12371	44 x 54	33	6	mit Edelstahldeckel with stainless cover
12353	44 x 54	33	6	mit Glasdeckel with glass cover

Speiseneinsatz / foodpan / cubeta / bac supérieur

12366



12372

Lieferung ohne Induktionskochplatte
delivery without induction plate
se entrega sin placa de inducción
livré sans plaque à induction

Chafing Dish rund „PREMIUM“



1 Gestell + 1 Wasserbecken mit Sandwichboden + 1 Wasserbeckenrahmen + 1 Deckel mit hydraulischem Gelenk + 1 runder Speisenbehälter, hitzebeständige Griffe, hochwertige Verarbeitung, ausschließlich für Induktionskochfelder

1 frame + 1 waterpan with sandwich base + 1 frame for waterpan + 1 hydraulic cover + 1 round foodpan, heat resistant handles, high quality, only for induction plates

1 soporte + 1 cubeta baño maría con base sandwich + 1 marco para cubeta baño maría + 1 tapa hidráulica + 1 cubeta redonda, asas resistentes al calor, acabado de alta calidad, solamente para inducción

1 pied support + 1 bac bain-marie avec fond sandwich + 1 cadre pour bac bain-marie + 1 couvercle hydraulique + 1 bac rond, poignées résistantes à la chaleur, finition de qualité, uniquement pour induction

	cm	↑ cm	ltr.	
12372	44 x 48	39	10	mit Edelstahldeckel with stainless cover
12354	44 x 48	39	10	mit Glasdeckel with glass cover

Speisenbehälter / foodpan / cubeta superior / bac supérieur

12397

GLOBE



die Deckelbremse sorgt für langsames Schließen
 the revolving cover closes gently, thanks to a special built-in axle
 sistema de freno para un cierre suave de la tapa
 système avec frein pour une fermeture en douceur du couvercle



abnehmbarer Glas-Deckel mit Wasserrücklaufsystem
 removable glass lid, with water-runback-system
 tapa transparente desmontable con sistema de retorno de la condensación
 couvercle transparent amovible avec système de retour de la condensation



Kondenswasser wird in das Wasserbecken zurückgeführt
 condensed water is led back into the waterpan
 el agua de condensación vuelve a la cubeta de agua
 l'eau de condensation retourne dans le bac d'eau



für alle Herdarten geeignet, auch für Induktionskochplatten
 suitable for all kinds of ovens, even induction cookers
 apto para todas las fuentes de calor, incluso inducción
 apte pour toutes les sources de chaleur, y compris induction



Induktionskochplatte für Chafing Dish

induction plate for chafing dish
 placa de inducción para chafing dish
 plaque à induction pour chafing dish

mit Regler
 with power control
 con control de potencia
 avec régulateur

	Ø cm	
12295	24	900 W

GN 1/1 Chafing Dish „GLOBE“



hochglanzpoliert, mit abnehmbarem hydraulischem Edelstahl-Deckel, Sandwichboden sorgt für optimale Wärmeleitung, für Induktionsplatten geeignet, Set: Gestell + Wasserbecken + Speisenbehälter GN 1/1 65 mm tief, 9 Liter + Löffelablage + 2 Brennpastenbehälter + Metallrahmen für Induktionskochplatte

mirror polished finish, removable stainless steel hydraulic cover, sandwich base for optimum heat distribution, suitable for induction plates

set: frame + waterpan + GN 1/1 container 65 mm, 9l + cutlery compartment ladles + 2 burner holder + frame for induction plate

pulido brillante, tapa hidráulica de acero inoxidable extraíble, fondo difusor sandwich apto para inducción, incluye: soporte + cubeta baño maría + cubeta GN 1/1 de 65 mm, 9 l + soporte para cuchara (sin cuchara) + 2 quemadores + marco para la placa de inducción

poli brillant, couvercle inox hydraulique amovible, fond diffuseur sandwich apte pour induction, comprend: pied support + bac bain-marie + bac GN 1/1 de 65 mm, 9 l + porte-louche (louche non incluse) + 2 brûleurs + cadre inox pour la plaque à induction



12394



12404

	cm	↑ cm	ltr.	
12394	66,5 x 44	34	9	mit Edelstahldeckel with stainless cover
12404	66,5 x 44	34	9	mit Glasdeckel with glass cover

Induktionskochplatte für Chafing Dish / induction plate for chafing dish / placa de inducción para chafing dish / plaque à induction pour chafing dish

12295

Metallrahmen für Induktionskochplatte / frame for induction plate / estructura o marco para placa de inducción / cadre support inox pour plaque induction

12296



12295



12296



GN 2/3 Chafing Dish „GLOBE“

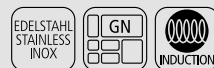

hochglanzpoliert, mit abnehmbarem hydraulischem Edelstahl-Deckel, Sandwichboden sorgt für optimale Wärmeleitung, für Induktionsplatten geeignet, Set: Gestell + Wasserbecken + 1 GN 2/3 Behälter 65 mm tief + Löffelablage + 1 Brennpastenbehälter + 1 Metallrahmen für Induktionskochplatte

mirror polished finish, removable hydraulic cover, sandwich base, optimum heat distribution, set: frame + waterpan + foodpan GN 2/3, 65 mm, 5,5 l + compartment for ladles + burner holder + frame for induction plate

pulido brillante, con tapa hidráulica extraíble, fondo difusor sandwich apto para inducción. Incluye: 1 pie, 1 cubeta baño maria, 1 cubeta GN 2/3 65 mm - 5,5 l, 1 soporte para cuchara (sin cuchara), 1 quemador, marco inox para la placa de inducción

poli brillant, couvercle hydraulique amovible, fond diffuseur sandwich apte pour induction. Comprend: pied, cuve bain-marie, bac inox GN 2/3-65 mm - 5,5 L, porte-louche (louche non incluse), brûleur, cadre inox pour la plaque à induction

	cm	↑ cm	ltr.	
12483	44 x 41	34	5,5	mit Edelstahl-Deckel with stainless steel cover
12484	44 x 41	34	5,5	mit Glasdeckel with glass cover



Chafing Dish „GLOBE“



hochglanzpoliert, mit abnehmbarem hydraulischen Edelstahl-Deckel, Sandwichboden sorgt für optimale Wärmeleitung, für Induktionsplatten geeignet

Set: Gestell + Wasserbecken + Speisenbehälter rund + Löffelablage + Brennpastenbehälter + Metallrahmen für Induktionskochplatte

mirror polished finish, removable hydraulic cover, sandwich base, optimum heat distribution, set: frame + waterpan + foodpan round + cutlery compartment ladles + burner holder + frame for induction plate

pulido brillante, con tapa hidráulica extraíble, fondo difusor sandwich apto para inducción. Incluye: 1 pie, 1 cubeta baño maria, 1 cubeta redonda, 1 soporte para cuchara (sin cuchara), 1 quemador, marco inox para la placa de inducción

brillant, couvercle hydraulique amovible, fond diffuseur sandwich apte pour induction. Comprend: pied, cuve bain-marie, bac inox rond, porte-louche (louche non incluse), 1 brûleur, cadre inox pour la plaque à induction

	Ø cm	↑ cm	ltr.	
12393	38,5	34	6	mit Edelstahldeckel with stainless cover
12403	38,5	34	6	mit Glasdeckel with glass cover

Induktionskochplatte für Chafing Dish / induction plate for chafing dish / placa de inducción para chafing dish / plaque à induction pour chafing dish

12295

Metallrahmen für Induktionskochplatten / frame for induction plate / marco para placa de inducción / cadre support inox pour plaque induction

12291

Speiseneinsatz / foodpan / cubeta / bac supérieur

12366

Porzellan-Einsatz / porcelain insert / bandeja de porcelana / bac supérieur en porcelaine

	Ø cm	↑ cm	ltr.	fits to
82210	39	6	4,3	12393, 12403
82215	39	6	4,0	12393, 12403



Suppen-Kugel inkl. Gestell „GLOBE“

soup bowl with stand
cubeta sopa con soporte
récipient à soupe avec pied



hochglanzpoliert, inkl. Speisenbehälter, 1 Brennpastenbehälter, mit einhängbarer Löffelablage, Sandwichboden sorgt für optimale Wärmeverteilung, für Induktionsplatten geeignet, einfaches Anbringen und Entfernen des Deckels, hitzeisolierende Griffe, 1 Metallrahmen für Induktionskochplatten

mirror polished finish, incl. foodpan and 1 burner holder, with fitting compartment for ladles, sandwich bottom for optimum heat distribution, gentle opening of the lid, heat-resistant handles, frame for induction plate

acabado pulido brillante, cubeta sopa inox, 1 quemador, platillo a colgar para el cucharón, fondo difusor sandwich, apto para inducción, tapa con apertura controlada, asas frías, marco para placa de inducción

poli brillant, récipient à soupe inox, 1 brûleur, repose-couvert à accrocher, fond diffuseur sandwich, apte pour induction, couvercle à ouverture contrôlée, anses froides, cadre support inox pour plaque à induction

	Ø cm	↑ cm	ltr.
12398	48	45	10

Induktionskochplatte für Chafing Dish / induction plate for chafing dish / placa de inducción para chafing dish / plaque à induction pour chafing dish

12295

Metallrahmen für Induktionskochplatten / frame for induction plate / marco para placa de inducción / cadre support inox pour plaque induction

12291

Suppen-Kugel „GLOBE“

soup bowl
cubeta sopa
récipient à soupe



hochglanzpoliert, inkl. Speisenbehälter, mit einhängbarer Löffelablage, Sandwichboden sorgt für optimale Wärmeverteilung, für Induktionsplatten geeignet, einfaches Anbringen und Entfernen des Deckels, hitzeisolierende Griffe (Lieferung ohne Gestell, Löffel)

mirror polished finish, incl. foodpan, with fitting compartment for ladles, sandwich bottom for optimum heat distribution, gentle opening of the lid, heat-resistant handles (delivery without rack, ladle)

acabado pulido brillante, cubeta sopa inox, platillo a colgar para el cucharón, fondo difusor sandwich, apto para inducción, tapa con apertura controlada, asas frías (cucharón no incluido)

poli brillant, récipient à soupe inox, repose-couvert à accrocher, fond diffuseur sandwich, apte pour induction, couvercle à ouverture contrôlée, anses froides (cadre, louche non incluse)

	Ø cm	↑ cm	ltr.
12399	48	32	10

Gestell inkl. Brenner / frame incl. burner / soporte incluyendo quemador / support, brûleur inclus

12396

Speisenbehälter / foodpan / cubeta superior / bac supérieur

12397



EASY INDUCTION



die Deckelbremse sorgt für langsames Schließen

the revolving cover closes gently, thanks to a special built-in axle

sistema de freno para un cierre suave de la tapa

système avec frein pour une fermeture en douceur du couvercle



Druckhebel zum leichten Entnehmen des GN-Behälters

stick for easy removing of the GN-container

dispositivo para levantar y quitar con facilidad la cubeta GN

dispositif pour lever et retirer facilement le bac GN



abnehmbarer Glas-Deckel mit Wasserrücklaufsystem

removable glas lid, with water-runback-system

tapa transparente desmontable con sistema de retorno de la condensación

couvercle transparent amovible avec système de retour de la condensation



Fixierschraube verhindert das Rutschen

fixing screw for skid resistance

Pie trasero anti-deslizante, altura regulable

Pied supplémentaire anti-dérapant réglable en hauteur

Lieferung ohne Induktionskochplatte
delivery without induction plate
se entrega sin placa de inducción
livré sans plaque à induction

GN 1/1 Chafing Dish „EASY INDUCTION“



1 Gestell + 1 Wasserbecken mit Sandwichboden + 1 Deckel mit hydraulischem Gelenk + 1 GN 1/1 Behälter 65 mm tief, hitzebeständige Griffe, hochwertige Verarbeitung, ausschließlich für Induktionskochfelder

1 frame + 1 waterpan with sandwich base + 1 hydraulic cover + 1 GN 1/1 container 65 mm, heat-resistant handles, high quality, only for induction plates

1 marco + 1 baño maría con base sandwich + 1 marco con tapa hidráulica + 1 cubeta GN 1/1 pan 65 mm profundo, asas resistentes al calor, buenos acabados, solamente para inducción

1 pied support + 1 bac bain-marie avec fond sandwich + 1 cadre avec couvercle hydraulique + 1 bac GN 1/1 - 65mm, poignées résistantes à la chaleur, belle qualité, uniquement pour induction

	cm	↑ cm	GN	ltr.
12322	60 x 42	30	1/1	9



Lieferung ohne Induktionskochplatte
delivery without induction plate
se entrega sin placa de inducción
livré sans plaque à induction

GN 2/3 Chafing Dish „EASY INDUCTION“



1 Gestell + 1 Wasserbecken mit Sandwichboden + 1 Wasserbeckenrahmen + 1 Deckel mit hydraulischem Gelenk + 1 GN 2/3 Behälter 65 mm tief, hitzebeständige Griffe, hochwertige Verarbeitung, ausschließlich für Induktionskochfelder

1 frame + 1 waterpan with sandwich base + 1 frame for waterpan + 1 hydraulic cover + 1 GN 2/3 container 65 mm, heat-resistant handles, high quality, only for induction plates

1 marco + 1 baño maría con base sandwich + 1 marco con tapa hidráulica + 1 cubeta GN 2/3 pan 65 mm profundo, asas resistentes al calor, buenos acabados, solamente para inducción

1 pied support + 1 bac bain-marie avec fond sandwich + 1 cadre avec couvercle hydraulique + 1 bac GN 2/3 - 65mm, poignées résistantes à la chaleur, belle qualité, uniquement pour induction

	cm	↑ cm	GN	ltr.
12323	42 x 41	30	2/3	5,5





Lieferung ohne Induktionskochplatte
delivery without induction plate
se entrega sin placa de inducción
livré sans plaque à induction

Chafing Dish „EASY INDUCTION“



1 Gestell + 1 Wasserbecken mit Sandwichboden + 1 Deckel mit hydraulischem Gelenk
+ 1 runder Speisenbehälter, hitzebeständige Griffe, hochwertige Verarbeitung,
ausschließlich für Induktionskochfelder geeignet

1 frame + 1 waterpan with sandwich base + 1 hydraulic cover + 1 round foodpan,
heat-resistant handles, high quality, good for induction plates

1 soporte + 1 baño maría con base sandwich + 1 tapa hidráulica + 1 cubeta redonda,
asas resistente al calor, buen acabado, apto para inducción

1 pied support + 1 bac bain-marie avec fond sandwich + 1 cadre avec couvercle hydraulique +
1 bac rond, poignées résistantes à la chaleur, belle qualité, uniquement pour induction

	cm	↑ cm	ltr.
12324	46 x 50	30	6



Lieferung ohne Induktionskochplatte
delivery without induction plate
se entrega sin placa de inducción
livré sans plaque à induction

Chafing Dish „EASY INDUCTION“



1 Gestell + 1 Wasserbecken mit Sandwichboden + 1 Deckel mit hydraulischem Gelenk +
1 runder Speisenbehälter, hitzebeständige Griffe, hochwertige Verarbeitung,
ausschließlich für Induktionskochfelder geeignet

1 frame + 1 waterpan with sandwich base + 1 hydraulic cover + 1 round foodpan,
heat-resistant handles, high quality, good for induction plates

1 soporte + 1 baño maría con base sandwich + 1 tapa hidráulica + 1 cubeta redonda,
asas resistente al calor, buen acabado, apto para inducción

1 pied support + 1 bac bain-marie avec fond sandwich + 1 cadre avec couvercle hydraulique +
1 bac rond, poignées résistantes à la chaleur, belle qualité, uniquement pour induction

	cm	↑ cm	ltr.
12325	48 x 42	39	11



Induktionskochplatte für Chafing Dish

induction plate for chafing dish
placa de inducción para chafing dish
plaque à induction pour chafing dish

mit Regler

with power control

con control de potencia

avec régulateur

	Ø cm	
12295	24	900 W



82210
4,3 ltr.

82215
2 x 2 ltr.

Porzellan-Einsatz

porcelain insert
bandeja de porcelana
bac supérieur en porcelaine



	Ø cm	↑ cm	ltr.	fits to
82210	39	6	4,3	12324, 12393, 12403
82215	39	6	4,0	12324, 12393, 12403

CHAFING DISHES



Rolltop-Chafing Dish „ELITE“



poliert, Rolltopdeckel klappbar auf 90° und 180°, Speisenbehälter GN 1/1 65 mm tief + Wasserbecken + 2 Brennpastenbehälter, wechseln des GN-Behälters ohne Abnehmen des Deckels (kein Kondenswasser-Rücklaufsystem)

polished, rolltop cover adjustable at 90° and 180°, foodpan GN 1/1 65 mm deep + waterpan + 2 burner holders, change of the GN container without removing the lid (condensed water can not be led back into the waterpan)

pulido brillante, tapa rolltop a 90° o 180°, cubeta GN 1/1 + 2 quemadores, cuba baño maría, se puede cambiar la cubeta GN sin retirar la tapa, importante: el agua condensada no revierte en los alimentos

poli brillant, couvercle rolltop ouverture de 90 a 180°, bac GN 1/1, bain-marie, 2 brûleurs, le bac GN peut être retiré et remplacé sans démonter le couvercle, important: la condensation ne retombe pas sur les aliments

	cm	↑ cm	ltr.
12350	67 x 47	45	9

Wasserbecken inkl. Vorrichtung für Heizelement / waterpan / baño maría / bain-marie

12249



inkl. Vorrichtung für Heizelement
incl. screws for heating unit



inkl. Vorrichtung
für Heizelement
incl. screws
for heating unit

Rolltop-Chafing Dish „CATERER“



Speisenbehälter GN 1/1 65 mm tief + Rolltopdeckel 90° + Wasserbecken inkl. Vorrichtung für Heizplatte + 2 Brennpastenbehälter (Lieferung ohne Heizplatte), massiver Ständer

foodpan GN 1/1 65 mm deep + rolltop cover 90° + waterpan with screws for heating unit + 2 burner holders (without heating unit), stable frame

1 cubeta GN 1/1 - 65 mm + campana rolltop abatible a 90° + 2 quemadores + cuba baño maría con fijaciones para resistencia amovible (se sirve sin la resistencia)

1 bac GN 1/1 - 65 mm + couvercle rolltop ouverture 90° + 2 brûleurs + 1 bac bain-marie avec 4 vis pour fixation résistance de chauffe amovible (non incluse)

	cm	↑ cm	ltr.
12245	67 x 35	45	9

Wasserbecken inkl. Vorrichtung für Heizelement / waterpan / baño maría / bain-marie

12249



Rolltopdeckel 90°
rolltop cover 90°

Rolltop-Chafing Dish „MAESTRO“



Speisenbehälter GN1/1 65 mm tief (passend auch für 100 mm) + Rolltopdeckel 90° + Wasserbecken inkl. Vorrichtung für Heizplatte + 2 Brennpastenbehälter

foodpan GN1/1 65 mm (also for 100 mm) + rolltop cover 90° + waterpan with screws for heating unit + 2 burner holders

cubeta GN 1/1 - 65 mm (hay espacio para una cubeta 100 mm) + campana rolltop abatible a 90° + 2 quemadores

bac GN 1/1 - 65 mm (accepte aussi bac ht. 100 mm) + couvercle rolltop ouverture 90° + 2 brûleurs

	cm	↑ cm	ltr.
12300	67 x 35	45	9



Chafing Dish „CATERER PRO“



Deckel hochglanzpoliert, Deckelgriffe hitzebeständig + 2 Brennpastenbehälter + Wasserbecken, inkl. Vorrichtung für Heizplatte + Gestell mit Deckelhalterung (ohne GN Speisenbehälter)

cover mirror polished finish, cover knob heat-resistant + 2 burner holders + waterpan with screws for heating unit + frame with coverholder (without GN foodpan)
tapa pulido brillante, asas frías + 2 quemadores + cuba inferior con tornillos para resistencia removible (no incluida) + tapa y estructura con sujeción de la tapa (se sirve sin la cubeta GN)
couvercle poli brillant, anses froides + 2 brûleurs + bac bain-marie
avec fixations pour résistance amovible (non incluse)

	cm	↑ cm
12233	64 x 35	34

Ersatzdeckel / replacement cover / tapa de recambio / couvercle de rechange

12236

Wasserbecken inkl. Vorrichtung für Heizelement / waterpan / baño maría / bain-marie

12249



Chafing Dish „CHEF“



Speisenbehälter GN 1/1 65 mm tief + 2 Brennpastenbehälter + Wasserbecken + Deckel + Gestell mit Deckelhalterung + langer Hohlgriff

foodpan GN 1/1 65 mm + 2 burner holders + waterpan + cove + frame with coverholder
1 cubeta GN 1/1 65 mm + 2 quemadores + cubeta para el agua + tapa y chasis con bloqueo para la tapa
1 bac GN 1/1 - 65 mm + 2 brûleurs + 1 bac bain-marie + couvercle + chasis avec blocage couvercle + poignée tube creux

	cm	↑ cm	ltr.
11675	61 x 31	30	9



Brennpastenbehälter

burner holder
soporte para quemador
porte-brûleur

nachfüllbar, für Chafing Dish, Deckel mit Bajonettverschluss

refillable, for Chafing Dish, lid with bayonet lock
recargable, para Chafing Dish, tapa con cierre de bayoneta
rechargeable, pour chafing dish, couvercle avec verrouillage par baïonnette



	Ø cm	↑ cm
11683	9	6

CHAFING DISHES



Elektro-Rolltop-Chafing Dish „ELITE“

electric rolltop chafing dish
chafing dish eléctrico rolltop
chafing dish électrique rolltop



Rolltopdeckel poliert, klappbar auf 90° und 180°, Elektro-Wasserbecken mit Temperaturregelung + Speisenbehälter GN 1/1 100 mm tief, 760 - 900 W, 230 V (kein Kondenswasser-Rücklaufsystem)

rolltop cover polished, adjustable at 90° and 180°, electric waterpan with adjustable heatcontrol + foodpan GN 1/1 100 mm deep, 760 - 900 W, 230 V (condensed water cannot be led back into the waterpan)

tapa abatible pulido brillante, apertura a 90° o 180°, baño maría c/ termostato + cubeta GN 1/1 - 100 mm, 760 - 900 W, 230 V (el agua condensada no gotea dentro de la cubeta)

couvercle rolltop poli brillant, ouverture à 90° ou 180°, bain-marie électrique avec thermostat + bac GN 1/1-100 mm, 760 - 900 W, 230 V (Important: la condensation ne retombe pas sur les aliments)

	cm	↑ cm	ltr.
12360	67 x 47	45	14

Wasserbecken, elektrisch / electric waterpan / baño maria eléctrico / bain-marie électrique

12224



Elektro Chafing Dish

electric chafing dish
chafing dish eléctrico
chafing dish électrique



Deckel poliert, Elektro-Wasserbecken mit Temperaturregelung + Speisenbehälter GN 1/1 100 mm tief, Deckelhalter, 900 W, 230 V

cover polished, electric waterpan with adjustable heatcontrol + foodpan GN 1/1 100 mm deep, lid holder, 900 W, 230 V

tapa pulido brillante, baño maría c/ termostato + cubeta GN 1/1 - 100 mm, sujeción de la tapa, 900 W, 230 V

couvercle poli brillant, bain-marie électrique avec thermostat + bac GN 1/1-100 mm, blocage du couvercle, 900 W, 230 V

	cm	↑ cm	ltr.
12225	63 x 36	29	14

Deckel / cover / tapa / couvercle

12235

Wasserbecken, elektrisch / electric waterpan / baño maria eléctrico / bain-marie électrique

12224



Elektro-Chafing Dish „ECO“

electric chafing dish
chafing dish eléctrico
chafing dish électrique



Deckel poliert, Elektro-Wasserbecken mit Temperaturregelung + Speisenbehälter GN 1/1 65 mm tief, Deckelhalter, 760 - 900 W, 230 V

cover polished, electric waterpan with adjustable heatcontrol + foodpan GN 1/1 65 mm deep, lid holder, 760 - 900 W, 230 V

tapa pulido brillante, baño maría c/ termostato + cubeta GN 1/1 - 65 mm, sujeción de la tapa, 760 - 900 W, 230 V

couvercle poli brillant, bain-marie électrique avec thermostat + bac GN 1/1 - 65 mm, blocage du couvercle, 760 - 900 W, 230 V

	cm	↑ cm	ltr.
12232	63 x 36	29	9

Wasserbecken, elektrisch / electric waterpan / baño maria eléctrico / bain-marie électrique

12224

**Elektrischer Suppentopf**

electric soup warmer
marmita de sopa eléctrica
marmite à soupe électrique



herausnehmbarer Einsatz aus Edelstahl, elektrisch, mit Wasserbad + Löffel + integrierter Tragering für den Innenbehälter, Deckel mit hitzeisolierendem Griff, Temperaturregelung 80°C (± 10°C), 450 - 550 W, 230 V

removable soup st. steel pan, bain marie electric, ladle, circular frame, thermostat control till 80°C (± 10°C), 450 - 550 W, 230 V

recipiente sopa inox extraible, baño maria eléctrico + cucharón + aro inox, tapa con asas frías, termostato hasta 80°C precisión (± 10°C), 450 - 550 W, 230 V

réceptif à soupe inox amovible, bain-marie électrique, louche, support circulaire inox, thermostat maxi 80°C (± 10°C), 450 - 550 W, 230 V

	Ø cm	↑ cm	ltr.
11901	38	36,5	10

**Elektrischer Suppentopf**

electric soup warmer
marmita de sopa eléctrica
marmite à soupe électrique



herausnehmbarer Einsatz aus Edelstahl, elektrisch, mit Wasserbad + Löffel + integrierter Tragering für den Innenbehälter, Deckel mit hitzeisolierendem Griff, Temperaturregelung 80°C (± 10°C), 400 - 450 W, 230 V

removable soup st. steel pan, bain marie electric, ladle, st. steel circular frame, thermostat control till 80°C (± 10°C), 400 - 450 W, 230 V

recipiente sopa inox extraible, baño maria eléctrico + cucharón + aro inox, tapa con asas frías, termostato hasta 80°C precisión (± 10°C), 400 - 450 W, 230 V

réceptif à soupe inox amovible, bain-marie électrique, louche, support circulaire inox, thermostat maxi 80°C (± 10°C), 400 - 450 W, 230 V

	Ø cm	↑ cm	ltr.
11910	40	37	10

**Elektrischer Suppentopf „ECONOMIC“**

electric soup warmer
marmita de sopa eléctrica
marmite à soupe électrique



Stahl schwarz lackiert, herausnehmbarer Einsatz aus Edelstahl, mit Wasserbad, Temperaturregelung 30°C - 90°C, dreh- und klappbarer Edelstahl-Deckel, inkl. 8 magnetisch haftenden Beschriftungen, 400 W, 230 V

metal, black, removable soup pot, with bain marie, thermostat 30°C - 90°C, st. steel lid, incl. 8 magnetic signs, 400 W, 230 V

metal negro, recipiente sopa inox extraible, con baño maria, termostato 30°C- 90°C, tapa inox, incluye 8 letreros magnéticos, 400 W, 230 V

acier, noir, réceptif à soupe inox amovible, avec bain-marie, thermostat 30°C - 90°C, couvercle inox, 8 étiquettes magnétiques, 400 W, 230 V

	Ø cm	↑ cm	ltr.
11915	32	36	9

Speisenbehälter / foodpan / recipiente sopa / réceptif à soupe

11916

Deckel / cover / tapa / couvercle

11917

CHAFING DISHES

4 tlg.
4 pcs.



12330



12335



12336



12337



12338



12339



82211

Chafing Dish, 4-teiliges Set

chafing dish set, 4 pcs.
chafing dish, set de 4
chafing dish, set de 4



4-teiliges Set:

- 1 Topf (8 Liter)
- 1 Speisenbehälter (4 Liter)
- 1 Deckel mit Sichtfenster und 1 Deckelbremse
- Topf mit induktionsfähigem Sandwich- / Kapselboden

4 pcs. set:

- 1 pot (8 litres),
- 1 foodpan (4 litres)
- 1 lid with glass insert and 1 automatic lid brake
- pot with induction-compatible sandwich base

set de 4:

- 1 olla (8 litros)
- 1 cubeta (4 litros)
- 1 tapa con ventanilla y 1 sistema de freno en la tapa
- olla con base sandwich apta para inducción

set de 4:

- 1 casserole (8 litres)
- 1 bac (4 litres)
- 1 couvercle avec fenêtre et 1 système de frein dans le couvercle
- casserole avec fond sandwich pour induction

	Ø cm	↑ cm	ltr.	Farbe / Colour	
12330	30,5	17,5	4		stainless
12335	30,5	17,5	4		copper
12336	30,5	17,5	4		yellow
12337	30,5	17,5	4		red
12338	30,5	17,5	4		black
12339	30,5	17,5	4		green

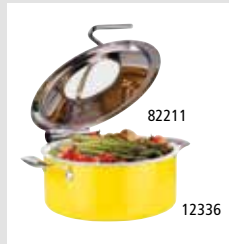

abnehmbarer Deckel
removable lid



induktionsgeeignet
suitable for induction

Ersatz-Speisenbehälter zu Chafing Dish / replacement foodpan for chafing dish / cubeta interior de repuesto para chafing dish / bac intérieur de remplacement pour le chafing dish

	Ø cm	↑ cm	ltr.	fits to
12329	30,5	8	4	12330, 12335, 12336, 12337, 12338, 12339



8 ltr. Topf
8 ltr. pot



Sandwich- / Kapsel-
boden / sandwich base



4 ltr. Speisenbehälter
4 ltr. foodpan



Deckelbremse
automatic lid break

Porzellaneinsatz

porcelain insert
bandeja de porcelana
bac en porcelaine



	Ø cm	↑ cm	ltr.	fits to
82211	29,5	9	3	12330, 12335, 12336, 12337, 12338, 12339



inklusive
Induktionskochplatte
900 Watt



NEW Kochplatte Ø 24 cm
induction station Ø 24 cm **4 tlg.**
4 pcs.

Induktionsstation, 4-tlg. Set
induction station, 4 pcs.
estación de inducción, set de 4
station d'induction, set de 4



4 teiliges Set:

- 1 Induktionskochplatte mit Regler (Ø 24 cm, 900 Watt)
- 1 Metallständer schwarz
- 1 Rahmen aus Eiche (wasserfest lackiert)
- 1 Edelstahlrahmen

4 pcs. set:

- 1 induction hotplate with controller (Ø 24 cm, 900 watt)
- 1 metal stand black
- 1 frame made of oak (water-resistant coated)
- 1 stainless steel frame

set de 4:

- 1 placa de inducción con regulador (Ø 24 cm, 900 vatios)
- 1 soporte de metal negro
- 1 caja de roble (con recubrimiento resistente al agua)
- 1 marco de acero inoxidable

set de 4:

- 1 plaque d'induction avec température réglable (Ø 24 cm, 900 watts)
- 1 support métallique noir
- 1 cadre en chêne (verni résistant à l'eau)
- 1 cadre en acier inox

	cm	↑ cm
12275	35,4 x 32,5	19



passendes Chafing Dish Set 12339
suitable chafing dish set 12339

Ersatzteile / replacement parts / piezas de repuesto / pièces de rechange

	cm	↑ cm	
12276	35,4 x 32,5	8,5	Holzrahmen / wooden frame
12272	29,5 x 26,5	1	Edelstahlrahmen / stainless steel frame
12295	Ø 24	-	900 Watt Induktionskochplatte / induction plate
15506	35,4 x 32,5	17,6	Buffetständer schwarz / buffet stand black



NEW

Induktionsstation, 2-tlg. Set

Induction station, 2-piece set
Estación de inducción, juego de 2 piezas
Station à induction, set de 2 pièces



Set, bestehend aus Induktionkochplatte 2000 Watt (no. 12285), inklusive Kabel-Fernbedienung, Leistung in Stufen regelbar, Rahmen aus Eichenholz (wasserfest lackiert) (no. 14051)

set consists of induction hotplate 2000 Watt, cable remote control, power adjustable in steps, frame made of oak (waterproof lacquered)

set, compuesto por placa de inducción 2000 Watt (no. 12285), incluye mando a distancia por cable, potencia regulable en pasos, madera de roble (lacado impermeable)

set, composé d'une plaque de cuisson à induction 2000 watts (no. 12285), télécommande filaire incluse, puissance réglable par paliers, bois de chêne (vernis imperméable)

	cm	↑ cm	
14050	39 x 39	10	2000 W



Einbau-Induktionskochplatte für Chafing Dish

built-in induction plate for chafing dish
placa de inducción para empotrar
plaque à induction à encastrer



inkl. Kabel-Fernbedienung, energiesparend, Leistung in 5 Stufen regelbar

incl. cable remote control, energy-saving, power adjustable in 5 steps
incl. mando a distancia con cable, ahorro energético, potencia regulable en 5 pasos
y compris télécommande filaire, économe en énergie, puissance réglable en 5 étapes

	cm	↑ cm	
12285	35,5 x 35,5	6	2000 W



Induktionskochplatte für Chafing Dish

induction plate for chafing dish
placa de inducción para chafing dish
plaque à induction pour chafing dish



inkl. Kabel-Fernbedienung, energiesparend, Leistung in 5 Stufen regelbar

incl. cable remote control, energy-saving, power adjustable in 5 steps
incl. mando a distancia con cable, ahorro energético, potencia regulable en 5 pasos
y compris télécommande filaire, économe en énergie, puissance réglable en 5 étapes

	Ø cm	
12295	24	900 W



Metallrahmen für Induktionskochplatten

frame for induction plate
marco para placa de inducción
cadre support inox pour plaque induction



12291	für runde Chafer / for round chafing dish
12296	für Chafer GN 1/1 / for GN 1/1 chafing dish



Elektro-Heizelement

heating unit
resistencia
résistance



mit einstellbarem Leistungsregler / adjustable heat control / abiertos con termostato /
contrôle de la chaleur réglable

12292	600 W / 230 V	for chafer covers are <u>closed</u> most of the time
12294	800 W / 230 V	for chafer covers are <u>open</u> most of the time



Heizplatte durch Spiralfeder an Wasserbad gedrückt
Heating plate is pressed against the water bath by a spiral spring

Mobile Chafing Dish Heizung

heating element
resistencia
résistance



für alle marktgängigen Chafing Dishes
suitable for all current popular chafing dishes, with special spring
para todos los chafing dish más corrientes
pour la plupart des chafing dish les plus courants

	Ø cm	↑ cm	
12299	14	9 - 11	500 W / 220 V



Rolltophaube „SWISS“

rolltop-cover
campana rolltop
cloche rolltop



hochglanzpoliert, klappbar auf 90°, nachrüstbar für alle handelsüblichen Chafer
mirror polished finish, cover adjustable at 90°, usable for all commercial chafing dishes
pulido brillante, tapa ajustable 90°, apto para todos los chafings profesionales
poli brillant, ouverture réglable à 90°, apte pour tous les chafings professionnels

	cm	↑ cm
12310	55 x 34	19,5



Bain-Marie Topf

bain marie pot
olla baño Maria
marmite bain-marie



inkl. Deckel, mit Löffelaussparung
included cover, notched for spoon
incluye tapa con hueco para la cuchara
inclut le couvercle avec espace pour la louche

	Ø cm	↑ cm	ltr.
12244	20	18	4,5

Deckel / cover / tapa / couvercle

11244



Bain-Marie Deckel

cover for bain marie
tapa del baño maria
couvercle du bain-marie



	cm
12243	54 x 33,5



Wärme-Kies

granite chips
granulado térmico
gravier thermique



für Chafing Dishes, feine Körnung, hohe Wärmespeicherung, kein Verkleben, ideal zum Warmhalten von Eiern
fine for chafing dishes and clean granite chippings, ideal for keeping eggs warm
gravilla de granito fina limpia, ideal para mantener los huevos calientes
gravier fin de granit, lavé, idéal pour maintenir les oeufs au chaud

	kg
81116	7



82274

Präsentationsmöglichkeit
presentation example

WARMERS



Wärmelampe mit 2 Infrarotlampen

thermal bridge
puente térmico
pont thermique



höhenverstellbar 58 - 77,5 cm, inklusive 2 Lampen, Kabellänge: 1,5 Meter

height ajustable from 58 to 77,5 cm, including 2 infrared lamps, cable length: 1,5 metres

regulable en altura de 58 a 77,5 cm, con 2 lámparas de infrarrojos, longitud del cable: 1,5 metros

réglable en hauteur de 58 à 77,5 cm, avec 2 lampes infrarouges, longueur du câble: 1,5 mètre

	cm	↑ cm	V	W	Farbe / Colour
12265	50 x 35	58 - 77,5	230	2 x 250	■

Ersatzbirne für Wärmelampe

infrared lamp / bulb
lámpara infrarrojos / bombilla
lampe infrarouge / ampoule

Fassung E27, Lichtfarbe: warmweiß

socket: E27, light colour: warm white

casquillo: E27, color de la luz: blanco cálido

douille: E27, couleur de lumière: blanc chaud

	W	fits to
12266	250	12265



Speisenwärmer

warmer
calienta platos
chauffe-plat



3-flammig / 3 lights / 3 velas / 3 bougies

	cm	↑ cm
35065	34 x 18	6



Speisenwärmer

warmer
calienta platos
chauffe-plat



2-flammig / 2 lights / 2 velas / 2 bougies

	cm	↑ cm
35343	34 x 13	6

TWO IN ONE



2,2 ltr.

65060

65061

6 Stk.
6 pcs.

65062

Fondue und Feuerzangenbowle-Set „TWO IN ONE“

fondue and fire punch bowl set
set para fondue o ponche caliente
service à fondue et à punch

13-teiliges Set aus Edelstahl bestehend aus:

1 Topf, 1 Rechaud, 1 Spritzschutz, 1 Untersetzer, 1 Schöpfkelle, 1 Feuerzange,
1 Pastenbrenner, 6 Fonduegabeln

13-piece stainless steel set consisting of:

1 pot, 1 rechaud, 1 splash guard, 1 coaster, 1 ladle, 1 fire tongs,
1 paste burner, 6 fondue forks

set de 13 piezas de acero inoxidable compuesto por:

1 olla, 1 rechaud, 1 protector contra salpicaduras, 1 trébede, 1 cazo,
1 pinza para el fuego, 1 quemador de pasta, 6 tenedores de fondue

set de 13 pièces en acier inox comprenant:

1 marmite, 1 rechaud, 1 pare-éclaboussures, 1 dessous de plat, 1 louche, 1 pince à feu,
1 brûleur à pâte, 6 fourchettes à fondue

EDELSTAHL
STAINLESS
INOX
18/8

PP
POLYPROPYLEN

	Ø cm	↑ cm	ltr.
65060	22	23	2,2

Brennpastenbehälter zu 65060

fuel paste container for 65060
recipiente para pasta de combustible para 65060
récipient pour pâte à combustible pour 65060

EDELSTAHL
STAINLESS
INOX
18/8

	cm	↑ cm	fits to
65061	26 x 12	10	65060

Gabelset zu 65060

fork set for 65060
set de tenedores para 65060
set de fourchettes pour 65060

EDELSTAHL
STAINLESS
INOX

PP
POLYPROPYLEN

	cm	→ cm	pcs.	fits to
65062	24	Griff / handle 8	6	65060

NEW

5 STARS



Töpfe aus emailliertem Gusseisen leiten nicht nur die Wärme gut, sondern können sie auch lange energieschonend speichern – ideal für den professionellen Einsatz am Buffet!

Cooking pots made of enamelled cast iron not only conduct heat well, but can also store it for a long time while conserving energy - ideal for professional use at the buffet!

Las ollas de hierro fundido esmaltado no sólo conducen bien el calor, sino que también pueden almacenarlo durante mucho tiempo conservando la energía: ¡ideales para un uso profesional en el buffet!

Les marmites en fonte émaillée ne conduisent pas seulement bien la chaleur, mais peuvent aussi la conserver longtemps en économisant de l'énergie - idéal pour une utilisation professionnelle au buffet!

NEW



88300 2,5 ltr.



88301 2,5 ltr.



88312 2,5 ltr.

Bräter mit Deckel „5 STARS“

roaster with lid
cacerola con tapa
cocotte avec couvercle



	Ø cm	↑ cm	ltr.	Farbe / Colour
88300	25	7 / 13	2,5	
88301	25	7 / 13	2,5	
88312	25	7 / 13	2,5	



88300

inklusive Deckelhalter
including lid holder

NEW



88302 4 ltr.



88303 4 ltr.



88313 4 ltr.

Kochtopf mit Deckel „5 STARS“
 cooking pot with lid
 olla con tapa
 marmite avec couvercle



	Ø cm	↑ cm	ltr.	Farbe / Colour
88302	25	11,5 / 17,5	4	
88303	25	11,5 / 17,5	4	
88313	25	11,5 / 17,5	4	



88302

inklusive Deckelhalter
 including lid holder

NEW



88304 3 ltr.



88305 3 ltr.



88314 3 ltr.

Bräter mit Deckel „5 STARS“
 roaster with lid
 cacerola con tapa
 cocotte avec couvercle



	Ø cm	↑ cm	ltr.	Farbe / Colour
88304	28	7 / 13,5	3	
88305	28	7 / 13,5	3	
88314	28	7 / 13,5	3	



88304

inklusive Deckelhalter
 including lid holder



Kochtopf mit Deckel „5 STARS“
 cooking pot with lid
 olla con tapa
 marmite avec couvercle



	Ø cm	↑ cm	ltr.	Farbe / Colour
88306	28	13 / 20	6	
88307	28	13 / 20	6	
88315	28	13 / 20	6	



inklusive Deckelhalter
 including lid holder



Bräter mit Deckel „5 STARS“
 roaster with lid
 cacerola con tapa
 cocotte avec couvercle



	cm	↑ cm	ltr.	Farbe / Colour
88308	33 x 25	11 / 17,5	5	
88309	33 x 25	11 / 17,5	5	
88316	33 x 25	11 / 17,5	5	



inklusive Deckelhalter
 including lid holder



Auflaufform „5 STARS“
casserole dish
fuente para gratinar
plat à four



	cm	↑ cm	ltr.	Farbe / Colour
88310	33 x 24	6,5	3,5	Red
88311	33 x 24	6,5	3,5	Black
88317	33 x 24	6,5	3,5	Teal

88310 3,5 ltr.

88311 3,5 ltr.

88317 3,5 ltr.



Deckelhalter, 2er Set
lid holder, 2 pcs.

soporte para tapa, set de 2
support de couvercle, set de 2



mit Antirutschbeschichtung, für alle Töpfe mit Deckel einsetzbar, hitzebeständig
with non-slip coating, suitable for all pots with lids, heat-resistant
revestimiento antideslizante, apto para todas las ollas con tapa, resistente al calor
avec revêtement antidérapant, adapté à toutes les casseroles avec couvercle, résistant à la chaleur

	cm	↑ cm	Farbe / Colour	pcs.
88320	10,5 x 8,5	3,5	Black	2



NEW SAMOWAR

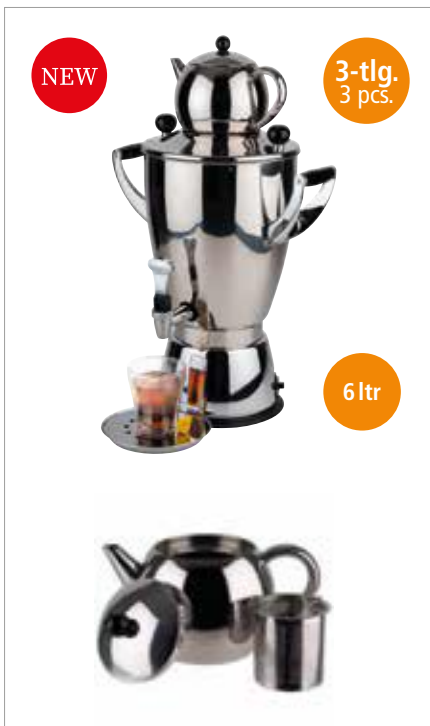

NEW

**3-tlg.
3 pcs.**

6 ltr

Samovar

samovar
samovar
samovar

3-teiliges Set:

- 1 Samovar, 230V, 50/60Hz, 1.800W (6 Liter)
- 1 Teekanne (1,1 Liter)
- 1 Tropfenschale

3 pcs. set:

- 1 samovar, 230V, 50/60Hz, 1.800W (6 ltr.)
- 1 teapot (1,1 ltr.)
- 1 drip tray

set de 3:

- 1 samovar, 230V, 50/60Hz, 1.800W (6 L.)
- 1 tetera (1,1 L.)
- 1 bandeja recogegotas

set de 3:

- 1 samovar, 230V, 50/60Hz, 1.800W (6 L.)
- 1 théière (1,1 L.)
- 1 bac ramasse-gouttes



cm ↑ cm ltr.

12315 35 x 21 58 6



NEW

**3-tlg.
3 pcs.**

12 ltr

Samovar

samovar
samovar
samovar

3-teiliges Set:

- 1 Samovar, 230V, 50/60Hz, 1.800W (12 Liter)
- 1 Teekanne (1,3 Liter)
- 1 Tropfenschale

3 pcs. set:

- 1 samovar, 230V, 50/60Hz, 1.800W (12 ltr.)
- 1 teapot (1,3 ltr.)
- 1 drip tray

set de 3:

- 1 samovar, 230V, 50/60Hz, 1.800W (12 L.)
- 1 tetera (1,3 L.)
- 1 bandeja recogegotas

set de 3:

- 1 samovar, 230V, 50/60Hz, 1.800W (12 L.)
- 1 théière (1,3 L.)
- 1 bac ramasse-gouttes



cm ↑ cm ltr.

12316 42 x 26 75 12



10,5 ltr.

Kaffeedispenser „HAPPY HOUR“

coffee dispenser
dispensador de café
distributeur de café



hochglanzpoliert, für warme Getränke, stabil und standfest, inkl. 1 Brennpastenbehälter
mirror polished finish, for warm drinks, solid and stable, incl. 1 burner holder
acabado pulido brillante para bebidas calientes, sólido y estable, incluye un calentador
brillant, pour boissons chaudes, avec 1 brûleur, robuste et stable

	cm	↑ cm	ltr.
11672	31 x 33,5	54,5	10,5

Hahn / tap / grifo / robinet

11671



Elektro-Heizelement

heating unit
resistencia
résistance



für Kaffeedispenser (Nr. 11672), 500 W, 220 V, einfach in das Gestell des Dispensers legen
for coffee dispenser (no. 11672), 500 W, 220 V, insert into the frame of the dispenser
para dispensador de café (11672), 500 W, 220V, directamente en el pie del dispensador
pour distributeur à café (11672), 500 W, 220 V, directement dans le support

12287	500 W / 220 V
-------	---------------



Kaffeetasse „SNUG“

coffee cup
taza de café
tasse à café



Porzellan, Griff: 2 cm / porcelain, handle: 2 cm / porcelana, asa: 2 cm / porcelaine, poignée: 2 cm

	Ø cm	↑ cm	ltr.	Farbe / Colour	VE / unit
16003	9,5	6	0,2		6
16004	9,5	6	0,2		6
16005	9,5	6	0,2		6



Kaffeuntertasse „SNUG“

coffee saucer
platico de café
soucoupe à café



Porzellan / porcelain / porcelana / porcelaine

	Ø cm	↑ cm	Farbe / Colour	VE / unit
16012	14,5	2,5		6
16013	14,5	2,5		6
16014	14,5	2,5		6

GN-CONTAINERS

GN-Behälter Größen nach EN 631

Alle Behälter sind aus rostfreiem Chrom-Nickel-Edelstahl mit elektrolytisch polierter (seidenmatt) Oberfläche und somit perfekt geeignet für den professionellen Einsatz.

GN-container according to EN 631

All pans are made of chrome/nickel stainless steel with a surface polished by electrolysis (satin-matt) and therefore highly suitable for professional operation.

De conformidad con la norma europea EN 631.

Todos los contenedores están fabricados en acero inoxidable cromado/niquelado con su superficie (satinada) pulida por electrolisis lo que la hace altamente apropiado para el uso profesional.

Bacs GN- Conforme à la norme EN 631

Tous les bacs sont fabriqués en inox/chrome/nickel, surface polie électrolythique (satiné). Approprié pour usage professionnel.

Vorteile der rund geprägten U-Ecken:

- erhöhte Stabilität durch verstärktes Profil
- zielgerechtes und sauberes Ausgießen
- genaue Positionierung der GN-Behälter
- superleichtes Stapeln und Entstapeln
- kein Verklemmen der GN-Behälter
- hohe Stoßfestigkeit durch robuste Konstruktion
- ansprechendes Design und stilvoller Blickfang

Advantages of the round-shaped U-Corners:

- increased stability due to the unique construction
- clean ladling and pouring
- exact positioning of the containers
- improved shock-resistance
- appealing design
- no seize of the containers

Ventajas de las esquinas en U:

Perfil reforzado que confiere mayor rigidez y resistencia a la cubeta, diseño para verter fácil y limpiamente, fáciles de apilar y desapilar sin que se claven entre sí, construcción más robusta y resistente a los golpes mecánicos, diseño elegante.

Avantages et fonctionnalité des angles en U:

Profil renforcé pour une meilleure consistance et rigidité du récipient, design qui facilite un versage propre et aisé, permet un empilage et désempilage faciles sans que les bacs restent coincés, meilleure résistance aux chocs mécaniques, seign élégant.

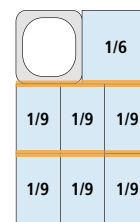
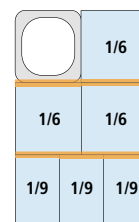
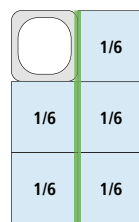
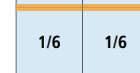
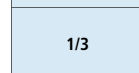
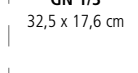
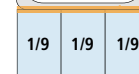
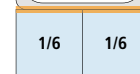
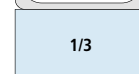
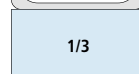
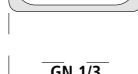
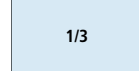
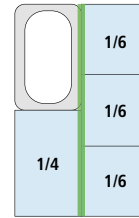
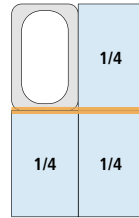
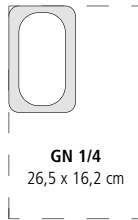
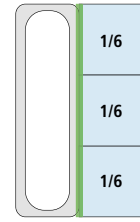
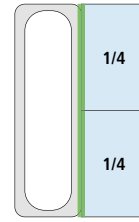
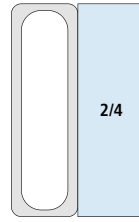
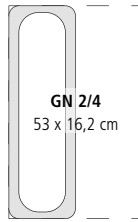
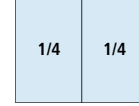
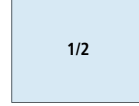
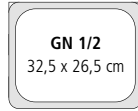
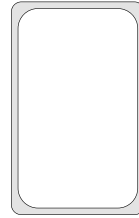



81102



81202



81301



81402



81604



81504



81702



81802

GN-Behälter

GN-container

GN cubetas

GN bacs



	GN	↓ mm	ltr.	cm
81000	2/1	20	5,0	53,0 x 65,0
81095	1/1	10	1,25	53,0 x 32,5
81100	1/1	20	2,5	53,0 x 32,5
81101	1/1	40	5,0	53,0 x 32,5
81109	1/1	55	6,5	53,0 x 32,5
81102	1/1	65	9,0	53,0 x 32,5
81104	1/1	100	13,25	53,0 x 32,5
81106	1/1	150	20,0	53,0 x 32,5
81108	1/1	200	25,0	53,0 x 32,5

	GN	↓ mm	ltr.	cm
81200	1/2	20	1,0	32,5 x 26,5
81201	1/2	40	2,0	32,5 x 26,5
81209	1/2	55	2,8	32,5 x 26,5
81202	1/2	65	4,0	32,5 x 26,5
81204	1/2	100	6,0	32,5 x 26,5
81206	1/2	150	8,75	32,5 x 26,5
81208	1/2	200	11,65	32,5 x 26,5

	GN	↓ mm	ltr.	cm
81300	1/3	20	0,75	32,5 x 17,6
81301 ^{NEW}	1/3	40	1,5	32,5 x 17,6
81302	1/3	65	2,5	32,5 x 17,6
81304	1/3	100	4,0	32,5 x 17,6
81306	1/3	150	5,7	32,5 x 17,6
81308	1/3	200	7,0	32,5 x 17,6

	GN	↓ mm	ltr.	cm
81400	1/4	20	0,5	26,5 x 16,2
81401	1/4	40	1,0	26,5 x 16,2
81402	1/4	65	1,8	26,5 x 16,2
81404	1/4	100	2,8	26,5 x 16,2
81406	1/4	150	4,0	26,5 x 16,2
81408	1/4	200	5,5	26,5 x 16,2

	GN	↓ mm	ltr.	cm
81602	1/6	65	1,0	17,6 x 16,2
81604	1/6	100	1,6	17,6 x 16,2
81606	1/6	150	2,4	17,6 x 16,2
81608	1/6	200	3,0	17,6 x 16,2

	GN	↓ mm	ltr.	cm
81502	1/9	65	0,6	17,6 x 10,8
81504	1/9	100	1,0	17,6 x 10,8
81506	1/9	150	1,5	17,6 x 10,8

	GN	↓ mm	ltr.	cm
81700	2/3	20	1,5	35,4 x 32,5
81701	2/3	40	3,0	35,4 x 32,5
81702	2/3	65	5,5	35,4 x 32,5
81704	2/3	100	8,4	35,4 x 32,5
81706	2/3	150	12,5	35,4 x 32,5
81707	2/3	200	18,0	35,4 x 32,5

	GN	↓ mm	ltr.	cm
81800	2/4	20	1,2	53,0 x 16,2
81801	2/4	40	2,4	53,0 x 16,2
81802	2/4	65	3,6	53,0 x 16,2
81804	2/4	100	5,6	53,0 x 16,2
81806	2/4	150	8,7	53,0 x 16,2

GN-CONTAINERS



perforierte GN-Behälter perforated GN-container cubetas GN perforadas bacs GN perforés



	GN	↓ mm	cm
81911	1/1	40	53,0 x 32,5
81907	1/1	65	53,0 x 32,5
81908	1/1	100	53,0 x 32,5
81909	1/1	150	53,0 x 32,5
81910	1/1	200	53,0 x 32,5
81901	1/2	65	32,5 x 26,5
81902	1/2	100	32,5 x 26,5
81903	1/2	150	32,5 x 26,5
81904	1/2	200	32,5 x 26,5
81905	2/3	65	35,4 x 32,5
81906	2/3	100	35,4 x 32,5



GN 1/6 Abklopfbehälter

GN 1/6 tapping container
GN 1/6 contenedor knock-out
GN 1/6 bac knock-out



mit Abklopfstange aus Silikon, rutschfester Boden
with silicone tapping rod, non-slip bottom
con varilla de silicona, base antideslizante
avec tige en silicone, fond antidérapant

	cm	↑ cm	ltr.
81611	17,6 x 16,2	15	2,4



rutschfester Boden
non-slip bottom



GN-Behälter Set, 4 teilig

GN-container, 4 pcs.
GN cubetas, set de 4
GN bacs, set de 4



bestehend aus: Edelstahlbehälter 1x GN 1/2 + 2x GN 1/4 + 1 Adapter
consisting of: stainless steel containers 1x GN 1/2 + 2x GN 1/4 + adapter
consiste en: cubetas de acero inoxidable 1x GN 1/2 + 2x GN 1/4 + adaptador
composé de: bacs en acier inox 1x GN 1/2 + 2x GN 1/4 + adaptateur

	GN	↓ mm	ltr.	cm	pcs
81850	1/2	65	4	32,5 x 26,5	1
	1/4	65	1,8	26,40 x 16,2	2
	Adapter			31,5	1

Lieferung in Farbverpackung
delivery in colour packaging

**GN-Deckel**

GN-lid
GN tapa
GN couvercle

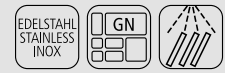
**ohne Löffelaussparung**

without notched edge for spoons
sin agujero para cucharón
sans espace pour louche

	GN	cm
81195	1/1	53,0 x 32,5
81295	1/2	32,5 x 26,5
81395	1/3	32,5 x 17,6
81495	1/4	26,5 x 16,2
81695	1/6	17,6 x 16,2
81591	1/9	17,6 x 10,8
81795	2/3	35,4 x 32,5
81895	2/4	53,0 x 16,2

**GN-Deckel**

GN-lid
GN tapa
GN couvercle

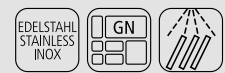
**mit Löffelaussparung**

with notched edge for spoons
con agujero para cucharón
avec espace pour louche

	GN	cm
81191	1/1	53,0 x 32,5
81292	1/2	32,5 x 26,5
81391	1/3	32,5 x 17,6
81492	1/4	26,5 x 16,2
81692	1/6	17,6 x 16,2
81595	1/9	17,6 x 10,8
81791	2/3	35,4 x 32,5
81891	2/4	53,0 x 16,2



Die Löffelaussparung mit Prägung verhindert das Zurückfließen von Flüssigkeit auf dem Deckel in den Behälter.

The notch for spoon with embossing prevents liquid on the lid from flowing back into the container.

GN-CONTAINERS



GN Transport-Steck-Deckel

GN-lid with silicone seal
GN tapa hermética con junta
GN couvercle hermétique avec joint



Silikondichtung, Griffmulde und Loch gegen Unterdruck, schwappsicherer Transport nicht für Kombidämpfer geeignet

silicone joint, flat handle, vent to compensate, slosh-proof transport, for pressure, not usable for steam oven
junta de silicona, asa empotrada, válvula para compensar, transporte sin salpicaduras, la presión, no se puede utilizar en hornos de vapor
joint silicone, anse encastrée, valve pour compenser la pression, transport sans éclaboussures, ne convient pas pour les étuves combinées

	GN	cm
80023	1/1	53,0 x 32,5
80024	1/2	32,5 x 26,5
80025	1/3	32,5 x 17,6
80026	1/4	26,5 x 16,2
80027	1/6	17,6 x 16,2
80028	2/4	53,0 x 16,2
80029	2/3	35,4 x 32,5



Adapter / Zwischensteg

adapter
adaptador
adaptateur



ermöglicht stabilen Halt von GN-Behältern im CD, rostfreier Chrom-Nickel-Edelstahl

for fixing GN pans, chrome / nickel stainless steel
para sujetar las cubetas GN, acero inox
support stable pour les bacs GN

	cm	
81996	15,9	längs bei GN 1/4 / lengthwise GN 1/4 longitud GN 1/4 / GN 1/4 dans la longueur
81997	17,6	längs bei GN 1/9 / lengthwise GN 1/9 longitud GN 1/9 / GN 1/9 dans la longueur
81999	32,5	quer bei GN 1/2 / crosswise GN 1/2 de ancho GN 1/2 / GN 1/2 dans la largeur
81998	52,5	längs bei GN 1/1 / lengthwise GN 1/1 longitud GN 1/1 / GN 1/1 dans la longueur



GN Abtropfgitter

GN-drainer
GN escurridor
GN égouttoir



Abtropfgitter aus Edelstahl für Gastronorm Behälter, passend für GN 1/1 und GN 1/2

stainless steel GN drainer for GN 1/1 + GN 1/2
escurridor GN de acero inoxidable para GN 1/1 + GN 1/2
égouttoir GN en acier inoxydable pour GN 1/1 + GN 1/2

	GN	cm	↑ cm
81117	1/1	45 x 25	1,5
81118	1/2	25 x 19	1,5

**GN-Behälter aus Polypropylen**

GN-container polypropylene
GN cubetas polipropileno
GN bacs polypropilène

**transparent: Skalierung in Liter, robust und formstabil**

transparent: liter scale, solid quality

transparente: graduación en litros, alta calidad

transparent: graduation en litres, haute-qualité

	GN	↓ mm	ltr.	cm
82104	1/1	65	8,5	53 x 32,5
82106	1/1	100	13,0	53 x 32,5
82108	1/1	150	19,5	53 x 32,5
82110	1/1	200	26,0	53 x 32,5

	GN	↓ mm	ltr.	cm
82112	1/2	65	3,9	32,5 x 26,5
82114	1/2	100	5,9	32,5 x 26,5
82116	1/2	150	8,9	32,5 x 26,5
82117	1/2	200	11,8	32,5 x 26,5

	GN	↓ mm	ltr.	cm
82118	1/3	65	2,4	32,5 x 17,5
82120	1/3	100	3,6	32,5 x 17,5
82122	1/3	150	5,3	32,5 x 17,6
82123	1/3	200	7,0	32,5 x 17,6

	GN	↓ mm	ltr.	cm
82128	1/4	65	1,7	26,5 x 16,2
82130	1/4	100	2,5	26,5 x 16,2
82132	1/4	150	3,7	26,5 x 16,2
82134	1/4	200	4,8	26,5 x 16,2

	GN	↓ mm	ltr.	cm
82136	1/6	65	1,0	17,6 x 16,2
82138	1/6	100	1,5	17,6 x 16,2
82140	1/6	150	2,2	17,6 x 16,2
82142	1/6	200	2,8	17,6 x 16,2

	GN	↓ mm	ltr.	cm
82150	1/9	65	0,6	17,6 x 10,8
82151	1/9	100	1,0	17,6 x 10,8



stapelbar
stackable



Skalierung
scaling

**GN-Deckel**

GN-lid
GN tapa
GN couvercle



	GN	↑ cm	cm
82101	1/1	1,5	53,0 x 32,5
82113	1/2	1,5	32,5 x 26,5
82119	1/3	1,5	32,5 x 17,6
82129	1/4	1,5	26,5 x 16,2
82137	1/6	1,5	17,6 x 16,2
82159	1/9	1,5	17,6 x 10,8

BLACK GN CONTAINERS



82065 GN 1/2 | 100 mm



82069 GN 1/3 | 100 mm



82073 GN 1/4 | 100 mm



82077 GN 1/6 | 100 mm



82081 GN 1/9 | 100 mm

GN-Behälter aus Polycarbonat

GN-container polycarbonate

GN cubeta policarbonato

GN bac polycarbonate

schwarz: Skalierung in Liter, robust und formstabil

black: liter scale, solid quality

negro: graduación en litros, alta calidad

noir : graduation en litres, haute-qualité



	GN	↓ mm	ltr.	cm
82064	1/2	65	3,9	32,5 x 26,5
82065	1/2	100	5,9	32,5 x 26,5
82066	1/2	150	8,9	32,5 x 26,5

	GN	↓ mm	ltr.	cm
82068	1/3	65	2,4	32,5 x 17,6
82069	1/3	100	3,6	32,5 x 17,6
82070	1/3	150	5,3	32,5 x 17,6

	GN	↓ mm	ltr.	cm
82072	1/4	65	1,7	26,5 x 16,2
82073	1/4	100	2,5	26,5 x 16,2
82074	1/4	150	3,7	26,5 x 16,2

	GN	↓ mm	ltr.	cm
82076	1/6	65	1,0	17,6 x 16,2
82077	1/6	100	1,5	17,6 x 16,2
82078	1/6	150	2,2	17,6 x 16,2

	GN	↓ mm	ltr.	cm
82081	1/9	100	1,0	17,6 x 10,8



passende Deckel, S. 421
suitable lid, page 421



stapelbar
stackable



GN-Behälter aus Polycarbonat

GN-container polycarbonate

GN cubeta polycarbonato

GN bac polycarbonate



	GN	↓ mm	ltr.	cm
82004	1/1	65	8,5	53 x 32,5
82006	1/1	100	13,0	53 x 32,5
82008	1/1	150	19,5	53 x 32,5
82010	1/1	200	26,0	53 x 32,5
	GN	↓ mm	ltr.	cm
82012	1/2	65	3,9	32,5 x 26,5
82014	1/2	100	5,9	32,5 x 26,5
82016	1/2	150	8,9	32,5 x 26,5
82017	1/2	200	11,8	32,5 x 26,5
	GN	↓ mm	ltr.	cm
82018	1/3	65	2,4	32,5 x 17,6
82020	1/3	100	3,6	32,5 x 17,6
82022	1/3	150	5,3	32,5 x 17,6
82023	1/3	200	7,0	32,5 x 17,6
	GN	↓ mm	ltr.	cm
82028	1/4	65	1,7	26,5 x 16,2
82030	1/4	100	2,5	26,5 x 16,2
82032	1/4	150	3,7	26,5 x 16,2
82034	1/4	200	4,8	26,5 x 16,2
	GN	↓ mm	ltr.	cm
82036	1/6	65	1,0	17,6 x 16,2
82038	1/6	100	1,5	17,6 x 16,2
82040	1/6	150	2,2	17,6 x 16,2
82042	1/6	200	2,8	17,6 x 16,2
	GN	↓ mm	ltr.	cm
82050	1/9	65	0,6	17,6 x 10,8
82051	1/9	100	1,0	17,6 x 10,8



GN-Deckel

GN-lid

GN tapa

GN couvercle



	GN	↑ cm	cm
82001	1/1	2,5	53,0 x 32,5
82013	1/2	2,5	32,5 x 26,5
82019	1/3	2,5	32,5 x 17,6
82029	1/4	2,5	26,5 x 16,2
82037	1/6	2,5	17,6 x 16,2
82059	1/9	2,5	17,6 x 10,8



GN Abtropfgitter

GN drainer

GN escurridor

GN égouttoir



	für GN	↑ cm	cm
82003	1/1	2	47,3 x 26,8
82005	1/2	2	26,8 x 20,8
82007	1/3	2	26,8 x 11,8
82009	1/4	2	20,6 x 10,8
82011	1/6	2	11,7 x 10,4



PORCELAIN GN CONTAINERS



GN-Behälter
GN-container
GN cubetas
GN bac



	GN	↓ mm	ltr.	cm
82100	1/1	60	7,1	53,0 x 32,5
82200	1/2	60	3,4	32,5 x 26,5
82300	1/3	60	2,0	32,5 x 17,6
82306	2/3	60	4,6	35,4 x 32,5
82301	2/4	60	3,0	53,0 x 16,2



GN-Behälter
GN-container
GN cubeta
GN bac



	GN	↓ mm	ltr.	cm	Farbe / colour
82270	1/1	60	7,1	53,0 x 32,5	Yellow
82271	1/1	60	7,1	53,0 x 32,5	Light Green
82272	1/1	60	7,1	53,0 x 32,5	Red
82273	1/1	60	7,1	53,0 x 32,5	Black
82274	1/2	60	3,4	32,5 x 26,5	Yellow
82275	1/2	60	3,4	32,5 x 26,5	Light Green
82276	1/2	60	3,4	32,5 x 26,5	Red
82277	1/2	60	3,4	32,5 x 26,5	Black
82278	1/3	60	2,0	32,5 x 17,6	Yellow
82279	1/3	60	2,0	32,5 x 17,6	Light Green
82280	1/3	60	2,0	32,5 x 17,6	Red
82281	1/3	60	2,0	32,5 x 17,6	Black



Präsentationsmöglichkeit
presentation example



Backblech
baking sheet
bandeja pastelera
plaque à pâtisserie



gelocht Ø 3 mm, Materialstärke 1,5 mm, Silikon beschichtet, temperaturbeständig bis 240°C
perforated Ø 3 mm, coated with silicon, heat resistant up to 240°C
aluminio con revestimiento de silicona perforada, resistente hasta 240°
aluminium avec revêtement silicone, perforée, température maxi 240°

	GN	cm
88285	1/1	53 x 32,5

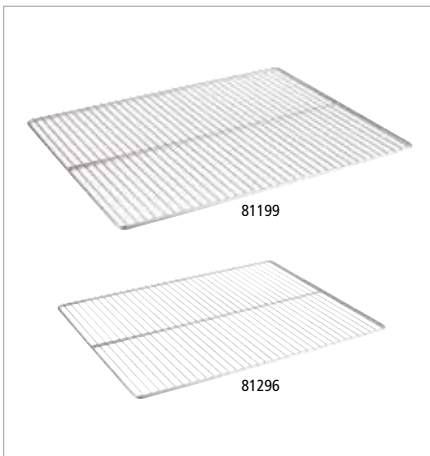

GN Roste
GN grid
GN rejilla
GN grille



elektrolytisch poliert, Drahtstärke 3 mm, Rahmendraht 6 mm, extra schwere Qualität
electro-polished, wire thickness 3 mm, frame wire 6 mm, extra heavy quality
inox pulido electrolítico, grosor alambre 3 mm, grosor marco 6 mm, calidad reforzada
inox poli électrolytique, fil 3 mm, cadre 6 mm, qualité renforcée

	GN	cm
81199	2/1	65,0 x 53,0
81198	1/1	53,0 x 32,5
81796	2/3	32,5 x 35,4
81296	1/2	32,5 x 26,5



GN 1/3 Bestecksammler
GN 1/3 container
GN 1/3 cubeta
GN 1/3 bac



mit 2 Haken zum Einhängen an Servier- oder Transportwagen
container with 2 hooks, to hang on trolleys for cutlery
cubeta con 2 ganchos para cubiertos, a colgar del carro
bac à couverts avec 2 crochets, à accrocher au chariot

	GN	↓ mm	cm
11978	1/3	150	32,5 x 17,5



GN Tablett „FRAMES“
GN tray
GN bandeja
GN plateau

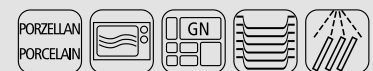

	GN	↑ cm	cm
82355	1/1	2	53,0 x 32,5
82356	1/2	2	32,5 x 26,5
82357	1/3	2	32,5 x 17,6



GN-CONTAINERS



GN-Behälter „ECOLINE“

GN container

GN cubeta

GN bac

mit Stapelnocke

with notching edge

con borde marcado para el apilado

avec rebord pour l'empilage



	GN	↓ mm	ltr.	cm	Farbe / Colour
83759	1/1	65	7,10	53,0 x 32,5	White
83755	2/4	65	3,00	53,0 x 16,2	White
83757	1/2	65	3,40	32,5 x 26,5	White
83753	1/3	65	2,00	32,5 x 17,6	White
83751	1/4	65	1,35	26,5 x 16,2	White
83749	1/6	65	0,80	17,6 x 16,2	White

	GN	↓ mm	ltr.	cm	Farbe / Colour
83758	1/1	65	7,10	53,0 x 32,5	Black
83754	2/4	65	3,00	53,0 x 16,2	Black
83756	1/2	65	3,40	32,5 x 26,5	Black
83752	1/3	65	2,00	32,5 x 17,6	Black
83750	1/4	65	1,35	26,5 x 16,2	Black
83748	1/6	65	0,80	17,6 x 16,2	Black

	GN	↓ mm	ltr.	cm	Farbe / Colour
84300	1/1	100	10,6	53,0 x 32,5	White
84302	2/4	100	4,3	53,0 x 16,2	White
84301	1/2	100	4,7	32,5 x 26,5	White
84303	1/3	100	2,7	32,5 x 17,6	White
84304	1/4	100	1,9	26,5 x 16,2	White
84305	1/6	100	1,0	17,6 x 16,2	White

	GN	↓ mm	ltr.	cm	Farbe / Colour
84306	1/1	100	10,6	53,0 x 32,5	Black
84308	2/4	100	4,3	53,0 x 16,2	Black
84307	1/2	100	4,7	32,5 x 26,5	Black
84309	1/3	100	2,7	32,5 x 17,6	Black
84310	1/4	100	1,9	26,5 x 16,2	Black
84311	1/6	100	1,0	17,6 x 16,2	Black



GN-Deckel

GN-lid

GN tapa

GN couvercle



	GN	cm
82001	1/1	53,0 x 32,5
82013	1/2	32,5 x 26,5
82019	1/3	32,5 x 17,6
82029	1/4	26,5 x 16,2
82037	1/6	17,6 x 16,2

NEW



79030 GN 1/1



79033 GN 1/2



79034 GN 1/3

GN Behälter „FRIENDLY“

GN pan
GN cubeta
GN bac



friendly

	cm	↑ cm	ltr.	Farbe / Colour	GN
79030	53 x 32,5	6,5	7,1	White	1/1
79031	53 x 32,5	6,5	7,1	Black	1/1
79032	32,5 x 26,5	6,5	3,4	White	1/2
79033	32,5 x 26,5	6,5	3,4	Black	1/2
79034	32,5 x 17,6	6,5	2	White	1/3
79035	32,5 x 17,6	6,5	2	Black	1/3
79036	32,5 x 17,6	10	2,7	White	1/3
79037	32,5 x 17,6	10	2,7	Black	1/3

GN Tablett „FRIENDLY“

GN tray
GN bandeja
GN plateau



friendly

	cm	↑ cm	Farbe / Colour	GN
79006	32,5 x 26,5	3,0	White	1/2
79007	32,5 x 26,5	3,0	Black	1/2



79006 GN 1/2



79007 GN 1/2

SERVING TROLLEYS



Servier- / Transportwagen

service trolley
carro de servicio
chariot de service



mit 3 Borden, Bordmaße 83 x 51 cm, Abstand zwischen den Borden 26 cm, Tragfähigkeit 120 kg, 4 Lenkrollen, davon 2 feststellbar, Lieferung demontiert, einfache Montage

with 3 trays, trays 83 x 51 cm, size between the trays 26 cm, total load capacity 120 kg, 4 wheels with 2 brakes, unassembled, simple assembly

con 3 bandejas inox mate, 83 x 51 cm, la medida entre bandejas 26 cm, capacidad total 120 kg, 4 ruedas con 2 frenos, construcción robusta, montaje fácil

3 niveaux, 83x51 cm chacun, distance entre niveaux 26 cm, capacité maxi 120 kg au total, 4 roues dont 2 avec frein, construction robuste, montage facile

	cm	↑ cm
11979	91 x 59	93



Servier- / Transportwagen

service trolley
carro de servicio
chariot de service



mit 2 Borden, Bordmaße 83 x 51 cm, Abstand zwischen den Borden 56 cm, Tragfähigkeit 80 kg, 4 Lenkrollen, davon 2 feststellbar, Lieferung demontiert, einfache Montage

with 2 trays, trays 83 x 51 cm, size between the trays 56 cm, total load capacity 80 kg, 4 wheels with 2 brakes, unassembled, simple assembly

con 2 bandejas de acero inoxidable mate, 83 x 51 cm, la medida entre bandejas 56 cm, capacidad total 80 kg, 4 ruedas, con 2 frenos, construcción robusta, montaje fácil

2 niveaux, 83 x 51 cm chacun, distance entre niveaux 56 cm, capacité maxi 80 kg au total, 4 roues dont 2 avec frein, construction robuste, montage facile

	cm	↑ cm
11977	91 x 59	93

**Servier- / Transportwagen**

serving trolley
carro de servicio
chariot de service



Aluminiumrahmen, 3 Böden, Abstand zwischen den Böden 31 cm, mit 4 Lenkrollen, alle mit Feststellern, Tragfähigkeit: 50 kg je Boden, 150 kg insgesamt, demontiert, einfache Montage, Lieferung ohne Container und Dekoration

frame aluminium, 3 shelves, distance between shelves 31 cm, 4 swivel wheels, all equipped with brakes, max. load per shelf 50 kg, 150 kg total, demounted, easy to mount, delivery without containers and decoration

marco aluminio, 3 pisos, distancia entre cada piso 31 cm, 4 ruedas giratorias, las 4 con frenos, carga máxima por bandeja 50 kg, 150 kg en total, se sirve desmontado, fácil de montar (se entrega sin contenedores ni decoración)

chassis aluminium, 3 étages, distance entre niveaux 31 cm, 4 roues pivotantes, toutes avec frein, charge maximum 50 kg par niveau, 150 kg au total, livré démonté, montage facile (livré sans récipients ni décoration)

	cm	↑ cm	
11945	108 x 50	96	without containers

Container zum Einhängen, passend zum Servier- / Transportwagen 11945

container to hang up, suitable serving trolley 11945
contenedor para colgar, adaptado para el carro ref. 11945
récipient à suspendre, pour chariot de service 11945



	cm	↑ cm	ltr.
11946	33 x 23	56,5	42
11947	33 x 23	17,5	13

**GN 1/1 Regalwagen**

GN 1/1 trolley
GN 1/1 carro
GN 1/1 chariot



mit 15 Doppelauflegeschieben, zum Transport von bis zu 30 GN-Tablets GN 1/2 oder 15 GN-Behältern bis GN 1/1 (Längseinschub), bei einem Stapelabstand von 75 mm, mit 4 Lenkrollen, 2 mit Feststellern, Tragfähigkeit 100 kg

15 double bars, for transporting up to 30 trays GN 1/2 or 15 GN containers up to GN 1/1 (lengthwise insertion), size between the trays 75 mm, with 4 swivel wheels, 2 with brakes, max. load 100 kg

15 raíles de soporte dobles, para transportar hasta 30 bandejas GN 1/2 o 15 cubetas GN hasta GN 1/1 (inserción longitudinal), distancia entre las bandejas de 75 mm, con 4 ruedas giratorias, 2 con freno, carga máxima de 100 kg

15 doubles rails de support, pour transporter jusqu'à 30 plateaux GN 1/2 ou 15 bacs GN jusqu'à GN 1/1 (insertion longitudinale), distance entre les plateaux 75 mm, avec 4 roues pivotantes, 2 avec frein, capacité de charge 100 kg

	cm	↑ cm
71441	55 x 38,5	173,5



mit beidseitiger Kipp- und Durchschubsicherung
with tilt and push-through protection on both sides

CUTLERY BOXES



Besteckbehälter

cutlery box
recipiente para cubiertos
réceptif pour couverts

Akazienholz, 4 Fächer (26 x 11,5 cm)

acacia wood, 4 compartments (26 x 11,5 cm)
madera de acacia, 4 compartimentos (26 x 11,5 cm)
bois d'acacia, 4 compartiments (26 x 11,5 cm)



	cm	↑ cm	Farbe / Colour	
11952	51 x 28	13		nature
11951	51 x 28	13		vintage white



Besteckbehälter mit Deckel

cutlery box with cover
caja de cubiertos con tapa
range-couverts avec couvercle

Akazienholz, 4 Fächer (26 x 11,5 cm), mit Deckel

acacia wood, 4 compartments (26 x 11,5 cm), with cover
madera de acacia, 4 compartimentos (26 x 11,5 cm), con tapa
bois d'acacia, 4 compartiments (26 x 11,5 cm), avec couvercle



	cm	↑ cm	Farbe / Colour	
11949	51 x 28	14,5		nature
11948	51 x 28	14,5		vintage white



GN 1/1 Besteckbehälter

GN 1/1 dispenser GN
GN 1/1 dispensador de cubiertos
GN 1/1 bac à couverts

in Handarbeit geflochten, 4 Mulden, Kunststoff-Geflecht, Drahtgestell, braun-schwarz

hand-woven, 4 troughs, plastic wickerwork, wire frame, brown-black
cesta trensada a mano, 4 compartimentos, mimbre de plástico, marco de alambre, marrón-negro
corbeille tressée à main, 4 compartiments, plastique tressé, armature en fil métallique, brun-noir



	cm	↑ cm	Farbe / Colour	GN
11966	53 x 32,5	9		1/1



GN 1/1 Besteckbehälter

GN 1/1 cutlery dispenser
GN 1/1 dispensador de cubiertos
GN 1/1 bac à couverts

4 Mulden, Kunststoff-Geflecht, Drahtgestell, beige

4 troughs, plastic wickerwork, wire frame, beige
4 compartimentos, mimbre de plástico, marco de alambre, beige
4 compartiments, plastique tressé, structure métallique, beige



	cm	↑ cm	Farbe / Colour	GN
11965	53 x 32,5	10		1/1



GN 1/1 Besteckbehälter

GN 1/1 cutlery bin
GN 1/1 recipiente para cubiertos
GN 1/1 récipients pour couverts



4 Mulden
4 troughs
4 compartimentos
4 compartments

	cm	↑ cm	Farbe / Colour	GN
11954	53 x 32,5	10	■	1/1
11955	53 x 32,5	10	■	1/1

3 Mulden, 3 Köcher
3 troughs, 3 cutlery baskets
3 compartimentos, 3 cestas para cubiertos
3 compartments, 3 corbeilles à couverts

	cm	↑ cm	Farbe / Colour	GN
11960	53 x 32,5	10	■	1/1



Besteckbehälter

cutlery basket
recipiente para cubiertos
récipients pour couverts



4 Löcher inklusive 4 Edelstahl Köcher
4 holes including 4 stainless baskets
4 agujeros con 4 cestas de acero inoxidable
4 trous avec 4 corbeilles en acier inox

	cm	↑ cm	Farbe / Colour
93321	27 x 27	15	■



Besteckköcher

cutlery basket
cesta para cubiertos
corbeille à couverts



Polyethylen weiß / polyethylene white plastic / polietileno blanco / polyéthylène blanc

	Ø cm	↑ cm
11998	9,5	13,5

Edelstahl matt poliert / stainless steel matt polished / acero inoxidable pulido mate / acier inox poli mat

	Ø cm	↑ cm
11999	9,5	13,5



Besteckkasten „INDUSTRIAL“

cutlery box
caja para cubiertos
boîte pour couverts



schwarz, mit Beschriftungsfach 6,5 x 2,5 cm
black, with labelling compartment 6,5 x 2,5 cm
negro, con compartimento de etiquetado 6,5 x 2,5 cm
noir, avec compartiment pour l'étiquetage 6,5 x 2,5 cm

	cm	↑ cm	ltr.
40676	23,0 x 15,5	13,0	2,4

CUTLERY BOXES

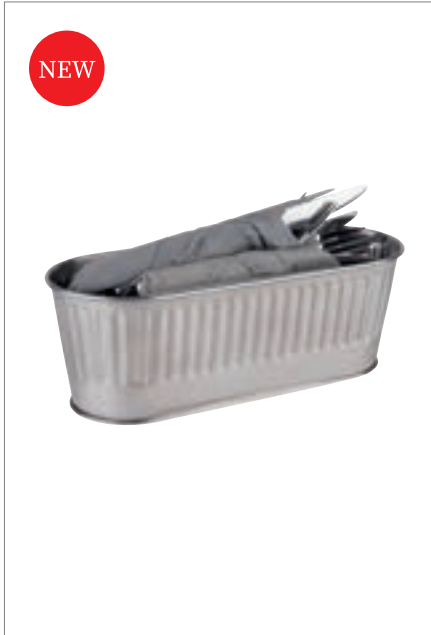

Besteckbehälter / Korb

cutlery bin / basket
 porta cubiertos / cesta
 range-couverts / corbeille
matt poliert, Boden: 29 x 8,5 cm
 matt polished, base: 29 x 8,5 cm
 pulido mate, base: 29 x 8,5 cm
 poli mat, fond: 29 x 8,5 cm



	cm	↑ cm	ltr.	Farbe / Colour
11752	29,5 x 12	10	2	■



Präsentationsmöglichkeit
 presentation example



Besteckbehälter / Korb

cutlery bin / basket
 porta cubiertos / cesta
 range-couverts / corbeille
Boden: 29 x 8,5 cm
 base: 29 x 8,5 cm
 base: 29 x 8,5 cm
 fond: 29 x 8,5 cm



	cm	↑ cm	ltr.	Farbe / Colour
11753	29,5 x 12	10	2	□



Präsentationsmöglichkeit
 presentation example

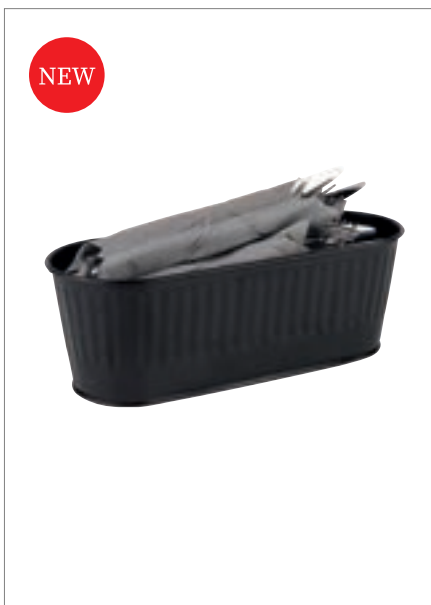

Besteckbehälter / Korb

cutlery bin / basket
 porta cubiertos / cesta
 range-couverts / corbeille
Boden: 29 x 8,5 cm
 base: 29 x 8,5 cm
 base: 29 x 8,5 cm
 fond: 29 x 8,5 cm



	cm	↑ cm	ltr.	Farbe / Colour
11754	29,5 x 12	10	2	■



Präsentationsmöglichkeit
 presentation example

NEW



inklusive 2 Schalen
included 2 bowls

Löffelablage mit 2 Schalen
spoon rest with 2 bowls
reposa cucharas con 2 cuencos
repose-cuillère avec 2 bols

inklusive 2 Schalen, Ø 12 cm, H: 5,5 cm, 250 ml, ohne Löffel
with 2 bowls Ø 12 cm, h: 5,5 cm, 250 ml, without a spoon
con 2 cuencos Ø 12 cm, h: 5,5 cm, 250 ml, sin cuchara
avec 2 bols Ø 12 cm, h: 5,5 cm, 250 ml, sans cuillère

original APS melamine EDELSTAHL STAINLESS INOX

	cm	↑ cm	Farbe / Colour
00651	23,5 x 12,5	19	■



Besteckablage
cutlery rest
reposa cuchara
pose-cuillère

EDELSTAHL STAINLESS INOX

	cm	↑ cm
00650	27 x 11	3,5



Besteckablage „SMALL WAVE“
cutlery rest
reposa cuchara
pose-cuillère

original APS melamine

	cm	↑ cm
83897	26 x 13	4,5



Besteckablage „BOWL“
cutlery rest
reposa cuchara
pose-cuillère

original APS melamine

	cm	↑ cm	ltr.
83803	22,5 x 11	6	0,5



Besteckablage „SPOON“
cutlery rest
reposa cuchara
pose-cuillère

original APS melamine

	cm	↑ cm
83801	26 x 10,5	5



Teig- und Pizzaballenbehälter
 dough and pizza ball container
 recipiente para masa y bolas de pizza
 récipient à pâte et boules à pizza



Innenmaß 56,5 x 36,5 cm, H: 6,5 cm
 inner dimension 56,5 x 36,5 cm, H: 6,5 cm
 medida interior 56,5 x 36,5 cm, H: 6,5 cm
 dimension intérieure 56,5 x 36,5 cm, H: 6,5 cm

	cm	↑ cm	ltr.
82440	60 x 40	7	13



stapelbar
 stackable

passender Deckel / fitting lid / tapa adecuada / couvercle approprié

	cm	↑ cm
82441	60 x 40	1



Eier-Box
 eggs box
 caja para huevos
 boîte à oeufs



mit luftdichtem Deckel, für 4 Lagen à 30 Eier, Lieferung inkl. 8 Lagen, Größe Lage: 28 x 28 cm
 with airtight cover, capacity: 4 trays of 30 eggs, delivery with 8 trays, size of tray: 28 x 28 cm
 capacidad para 4 bandejas de 30 huevos, tapa hermética, se entrega con 8 bandejas, formato bandejas 28 x 28 cm, apto para lavavajillas
 pour 4 plateaux de 30 oeufs chacun, apte pour 4 plateaux plans, couvercle hermétique, livré avec 8 plateaux, dimension plateau 28x28 cm, lavable en lave-vaisselle

	cm	↑ cm	GN
82419	35,4 x 32,5	20	2/3

10 Lagen / 10 trays / 10 bandejas / 10 plateaux

82420



Wanne
 container
 cubeta
 bac



	cm	↑ cm	ltr.
11940	61 x 44	15	25



Wanne
 container
 cubeta
 bac



	cm	↑ cm	ltr.
11950	55 x 42	14	20



Profi-Eimer
bucket
cubo
seau



mit Ausgießer und geprägter Maßskalierung innen
with spout and embossed dimension scaling inside
con pico y escala de medición en relieve en el interior
avec bec verseur et échelle de mesure en relief à l'intérieur

	Ø cm	↑ cm	ltr.	Farbe / Colour
30075	28,5	28,5	10,5	White
30076	33,0	32,0	17,0	White
30077	28,5	28,5	10,5	Black
30078	33,0	32,0	17,0	Black



mit Griff
with handle



Maßskalierung innen
dimension scaling inside



Auslaufnase für sicheres Handling
discharge nose for safe handling



Trichter „PROFI“
funnel
embudo
entonnoir



mit Öse
with eyelet
con ojal
avec œillet

	Ø cm	Ø mm Durchlass	
30065	6	8	
30066	8	11	
30067	10	12	
30068	12	12	
30069	14	15	
30070	17	17	mit Sieb / incl. strainer
30071	21	20	mit Sieb / incl. strainer



erleichtert das Einfüllen
facilitates filling



Anwendungsmöglichkeit
applicability



mit einsetzbarem Sieb
incl. insertable strainer



Bar, Café & Drinkware

TABLE LAMPS	436
BOTTLE COOLERS	442
BEVERAGE DISPENSERS	454
DRINKING CUPS	456
MOSCOW MULE	460
MUGS	463
SHAKERS	466
JIGGERS	468
MUDDLERS	470
BAR SPOONS	471
BAR STRAINERS	472
DRIP MATS	474
STRAWS	475
ICE BUCKETS	476
ICE CUBE MAKERS	478
TONGS	479
POURERS	480
CORKSKREWS BARBLADES	482
CONFERENCE BOTTLE COOLER	483
LEMON SQUEEZERS	484
TEAPOTS	486
BARISTA	488
TO GO	497
DRINKING BOTTLES	499
TRAYS	500
FAST FOOD TRAYS	504
BILL PRESENTERS CRUMBERS	505
ASHTRAYS	506
BINS	510



TABLE LAMPS



Die APS LED-Tischleuchten sind wiederaufladbare, kabellose, batteriebetriebene Leuchten. Ein Knopf an der Unterseite ermöglicht das Ein- und Ausschalten. Ausgestattet mit einem Dimmschalter, schaffen diese Leuchten ein perfektes Ambiente für Ihr Wohlbefinden und bieten bis zu 15-20 Stunden Betrieb mit einer einzigen Ladung. Die Leuchten sind sowohl für den Innen- als auch für den Außenbereich geeignet. Jede Leuchte wird mit einer Kontaktladestation geliefert; das Ladegerät und die Fernbedienung sind ebenfalls im Lieferumfang enthalten. Sie sind einfach aufzuladen und aufzubewahren, da sie magnetisch befestigt werden können, und verbrauchen wenig Strom.

The APS LED Table Lamps are rechargeable battery-powered cordless lamps. A "push" control on the bottom allows switching on/off. Equipped with a dimmer switch, these lamps create a perfect ambiance for you your well-being and offer up to 15-20 hours of operation on a single charge. The lamps are suitable for both indoor and outdoor use. Each lamp comes with a contact charging base; the battery charger and remote control are also included. They are easy to charge and store with magnetic connectors and low in LED power consumption.

Las lámparas de mesa LED de APS son lámparas inalámbricas recargables que funcionan con pilas. Un mando "push" situado en la parte inferior permite encenderlas y apagarlas. Equipadas con un regulador de intensidad, estas lámparas crean un ambiente perfecto para su bienestar y ofrecen hasta 15-20 horas de funcionamiento con una sola carga. Las lámparas son perfectas para su uso tanto en el interior como para el exterior. Cada lámpara viene con una estación de carga por contacto; el cargador de pilas y el mando a distancia también están incluidos. Son fáciles de cargar y almacenar gracias a sus conectores magnéticos y tienen un bajo consumo de energía LED.

Les lampes de table LED d'APS sont des lampes rechargeables, sans fil et fonctionnant sur piles. Un bouton poussoir ("push") situé sur le dessous permet de les allumer et de les éteindre. Equipées d'un variateur de lumière, ces lampes créent une ambiance parfaite pour votre bien-être et offrent jusqu'à 15-20 heures de fonctionnement avec une seule charge. Les lampes conviennent aussi bien à l'intérieur qu'à l'extérieur. Chaque lampe est livrée avec une station de recharge à contact ; le chargeur de batterie et la télécommande sont également inclus. Elles sont faciles à charger et à ranger grâce à des connecteurs magnétiques et consomment peu d'énergie.

NEW



17000



17001



17002

Tischleuchte „MERLE“

table lamp
lámpara de mesa
lampe de table



inklusive Ladestation, USB Ladekabel (ohne Netzteil), Fernbedienung inkl. Batterie

charging station included, USB charging cable (without mains adapter), remote control incl. battery
con estación de carga, cable de carga USB (sin adaptador de red), mando a distancia incl. batería
avec station de charge, câble de charge USB (sans bloc d'alimentation), télécommande avec batterie

	Ø cm	↑ cm	Farbe / Colour
17000	11	30,5	
17001	11	30,5	
17002	11	30,5	



TABLE LAMPS



Tischleuchte „FINN“
table lamp
lámpara de mesa
lampe de table



inklusive Ladestation, USB Ladekabel (ohne Netzteil), Fernbedienung inkl. Batterie

charging station included, USB charging cable (without mains adapter), remote control incl. battery
con estación de carga, cable de carga USB (sin adaptador de red), mando a distancia incl. batería
avec station de charge, câble de charge USB (sans bloc d'alimentation), télécommande avec batterie

	Ø cm	↑ cm	Farbe / Colour
17006	13	25	White



Tischleuchte „NIELS“
table lamp
lámpara de mesa
lampe de table



inklusive Ladestation, USB Ladekabel (ohne Netzteil), Fernbedienung inkl. Batterie

charging station included, USB charging cable (without mains adapter), remote control incl. battery
con estación de carga, cable de carga USB (sin adaptador de red), mando a distancia incl. batería
avec station de charge, câble de charge USB (sans bloc d'alimentation), télécommande avec batterie

	Ø cm	↑ cm	Farbe / Colour
17007	11,5	16	



Tischleuchte „CLEO“
table lamp
lámpara de mesa
lampe de table



inklusive Ladestation, USB Ladekabel (ohne Netzteil), Fernbedienung inkl. Batterie

charging station included, USB charging cable (without mains adapter), remote control incl. battery
con estación de carga, cable de carga USB (sin adaptador de red), mando a distancia incl. batería
avec station de charge, câble de charge USB (sans bloc d'alimentation), télécommande avec batterie

	Ø cm	↑ cm	Farbe / Colour
17003	12	30,5	
17004	12	30,5	
17005	12	30,5	

TABLE LAMPS

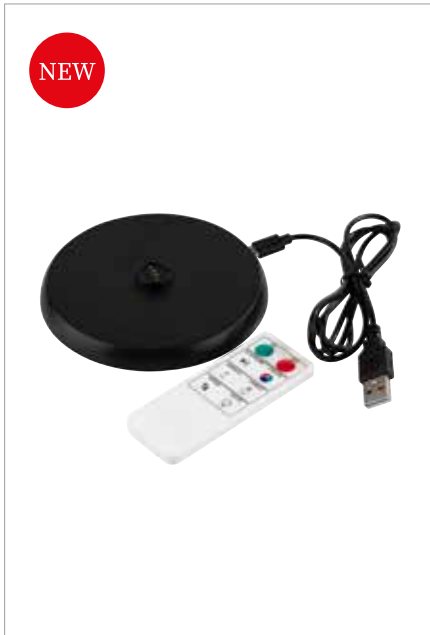

NEW

Ersatzteilset für Tischleuchten

spare parts set for table lamp
set de repuesto para lámpara
set de pièces de rechange

Set bestehend aus:

- Ladeplatte
- Kabel (USB A auf USB C)
- Fernbedienung inklusive Batterie

set consisting of:

- charging plate
- cable (USB A auf USB C)
- remote control incl. battery

set compuesto por:

- placa de carga
- cable (USB A a USB C)
- mando a distancia incl. batería

set composé de:

- plaque de chargement
- câble (USB A vers USB C)
- télécommande avec batterie

ABS
KUNSTSTOFF

	cm	↑ cm	Farbe / Colour
17023	11	1	■



NEW

Rohre für Ladestation

tubes for charging station
tubos para estación de carga
tubes pour station de charge

passend zu Ladestation

suitable for charging station

para estación de carga

pour station de charge

METALL

	Ø cm	↑ cm	fits to	pcs.	Farbe / Colour
17022	2	43	17020, 17021	4	■



NEW

Ladestation, 6-fach

charging station, 6-fold
estación de carga, 6 vías
station de charge, 6 places

Platzsparend und transportsicher!

Die Tischleuchten werden auf die magnetischen Kontakte der Ladestation gestellt und können nicht von der Station fallen – kippsicherer Transport! Zwei Ladestationen können mit Hilfe von vier Verbindungsröhren (Art.-Nr. 17022) als Doppeldecker-Ladestation verbunden werden – mit einem Kabel können bis zu 12 Leuchten gleichzeitig geladen werden.

Space-saving and transport-safe!

The table lamps are placed on the magnetic contacts of the charging station and cannot fall off the station - tilt-proof transport! Two charging stations can be connected as a double-decker charging station using four connecting tubes (art. no. 17022) - up to 12 lights can be charged simultaneously with one cable.

Ahorro de espacio y transporte seguro.

Las lámparas de mesa se colocan en los contactos magnéticos de la estación de carga y no pueden caerse de la estación - ¡transporte antivuelco! Se pueden conectar dos estaciones de carga como estación de carga de dos pisos utilizando cuatro tubos de conexión (ref. 17022) - se pueden cargar hasta 12 lámparas simultáneamente con un solo cable.

Peu encombrante et sûre pour le transport !

Les lampes de table sont placées sur les contacts magnétiques de la station de recharge et ne peuvent pas tomber de la station - transport sans risque de basculement ! Deux stations de charge peuvent être reliées à l'aide de quatre tubes (art. n° 17022) de liaison pour former une station de charge à deux étages - un câble permet de charger jusqu'à 12 lampes simultanément.

ABS
KUNSTSTOFF

	cm	↑ cm	Farbe / Colour
17020	43 x 31,5	5	■



NEW



Ladestation, 15-fach
charging station, 15-fold
estación de carga, 15 vías
sation de charge, 15 places



Platzsparend und transportsicher!

Die Ladestation passt maßlich perfekt auf den Servier-/Transportwagen (Art.-Nr. 11977). Die Tischleuchten werden auf die magnetischen Kontakte der Ladestation gestellt und können nicht von der Station fallen – kippsicherer Transport! Zwei Ladestationen können mit Hilfe von vier Verbindungsrohren (Art.-Nr. 17022) als Doppeldecker-Ladestation verbunden werden – mit einem Kabel können bis zu 30 Leuchten gleichzeitig geladen werden.

Space-saving and transport-safe!

The charging station fits perfectly on the serving/transport trolley (art. no. 11977). The table lamps are placed on the magnetic contacts of the charging station and cannot fall off the station - tilt-proof transport! Two charging stations can be connected as a double-decker charging station using four connecting tubes (art. no. 17022) - up to 30 lights can be charged simultaneously with one cable.

Ahorro de espacio y transporte seguro.

La estación de carga encaja perfectamente en el carro de servicio/transporte (ref. 11977). Las lámparas de mesa se colocan en los contactos magnéticos de la estación de carga y no pueden caerse de la estación - ¡transporte antivuelco! Se pueden conectar dos estaciones de carga como estación de carga de dos pisos utilizando cuatro tubos de conexión (ref. 17022) - se pueden cargar hasta 30 lámparas simultáneamente con un solo cable.

Peu encombrante et sûre pour le transport !

Les dimensions de la station de chargement s'adaptent parfaitement au chariot de service/transport (art. n° 11977). Les lampes de table sont placées sur les contacts magnétiques de la station de recharge et ne peuvent pas tomber de la station - transport sans risque de basculement ! Deux stations de charge peuvent être reliées à l'aide de quatre tubes (art. n° 17022) de liaison pour former une station de charge à deux étages - un câble permet de charger jusqu'à 30 lampes simultanément.

	cm	↑ cm	Farbe / Colour
17021	75 x 43	5	■



Servier- / Transportwagen
service trolley
carro de servicio
chariot de service



mit 2 Borden, Bordmaße 83 x 51 cm, Abstand zwischen den Borden 56 cm, Tragfähigkeit 80 kg, 4 Lenkrollen, davon 2 feststellbar, Lieferung demontiert, einfache Montage
with 2 trays, trays 83 x 51 cm, size between the trays 56 cm, total load capacity 80 kg, 4 wheels with 2 brakes, unassembled, simple assembly

con 2 bandejas de acero inoxidable mate, 83 x 51 cm, la medida entre bandejas 56 cm, capacidad total 80 kg, 4 ruedas, con 2 frenos, construcción robusta, montaje fácil
2 niveaux, 83 x 51 cm chacun, distance entre niveaux 56 cm, capacité maxi 80 kg au total, 4 roues dont 2 avec frein, construction robuste, montage facile

	cm	↑ cm
11977	91 x 59	93

BOTTLE COOLERS



Wein- / Sektkühler

wine / champagne bowl
cubitera para vino y cava
seau à vin ou champagne



innen matt poliert, außen hochglanzpoliert, mit massiven Knopf-Griffen, extra stabiler eingerollter Rand, schwere Ausführung

outside mirror polished, inside matt polished, with solid knob handles, rolled edge, heavy quality
exterior pulido brillante, interior pulido mate, asas de botón robustas, borde redondeado, alta calidad
extérieur poli brillant, intérieur poli mat, 2 poignées robuste en forme de bouton, bord arrondi, haute qualité

	Ø cm	↑ cm	ltr.
36028	21,5 / 16	22	4



Wein- / Sektkühler „HAMMERSCHLAG“

wine / champagne bowl
cubitera para vino y cava
seau à vin ou champagne



hochglanzpoliert, mit massiven Ring-Griffen, eingerollter Rand

mirror polished, with solid ring handles, rolled edge, hammered
pulido brillante, con 2 anillos macizos, borde redondeado, repujado
brillant, 2 anneaux massifs, bord arrondi, surface martelée

	Ø cm	↑ cm	ltr.
36026	21 / 17	21,5	4



Wein- / Sektkühler

wine / champagne bowl
cubitera para vino y cava
seau à vin ou champagne



innen matt poliert, außen hochglanzpoliert, mit massiven Griffen, Rand eingerollt

outside mirror polished, inside matt polished, with massive handles, rolled edge
exterior pulido brillante, interior pulido mate, 2 asas macizas, borde redondeado
extérieur poli brillant, intérieur poli mat, 2 anses massives, bord rond

	Ø cm	↑ cm	ltr.
36025	21 / 15	21	3,5



Wein- / Sektkühler

wine / champagne bowl
cubitera para vino y cava
seau à vin ou champagne



matt poliert, Hohlgriffe / matt polished, hollow handles / pulido mate, con asas huecas / poli mat, 2 boutons creux

	Ø cm	↑ cm	ltr.
36021	20 / 15	20,5	4



Wein- / Sektkühler

wine / champagne bowl
cubitera para vino y cava
seau à vin ou champagne



aussen hochglanzpoliert, innen matt poliert, mit Ring-Griffen

outside mirror polished, inside matt polished, with ring handles
exterior pulido brillante, interior pulido mate, con 2 asas anillos
extérieur poli brillant, intérieur poli mat, avec 2 anneaux

	Ø cm	↑ cm	ltr.
36020	20 / 15	19	3



Mini-Eiseimer / Mini-Sektkühler

ice bucket
cubitera clásica
seau à glaçons classique



	Ø cm	↑ cm	ltr.
36003	10,5	10	0,5
36004	13,0	13	1,0



Flaschenkühler „MOSCOW MULE“

bottle cooler
enfriador de botellas
rafraîchisseur de bouteilles

Edelstahl-Flaschenkühler, Antik-Kupfer-Look
stainless steel cooler, copper antique look
enfriador de acero inoxidable, cobre estilo antiguo
rafraîchisseur en acier inox, cuivre style antique



	Ø cm	↑ cm	ltr.	
93330	20	21	5	copper-antique-hammered



Wein- / Sektkühler

wine / champagne bowl
cubitera para vino y cava
seau à vin ou champagne

schwarz matt, mit 2 Griffen, extra stabiler eingerollter Rand
black matt, with 2 handles, rolled edge
negro mate, con 2 asas, borde redondeado
noir mat, avec 2 poignées, bord arrondi



	Ø cm	↑ cm	ltr.
36115	21,5 / 15	22	5



Wein- / Sektkühler

wine / champagne bowl
cubitera para vino y cava
seau à vin ou champagne

glasklar, mit Tragegriff
transparent, handle on the side
transparente, con un asa en el lateral
transparent, avec poignée



	cm	↑ cm	ltr.
36055	23 x 22	27,5	3



Wein- / Sektkühler

wine / champagne bowl
cubitera para vino y cava
seau à vin ou champagne

glasklarer Rand, transparent gefrostet
edge transparent, body transparent frosted
borde transparente, cuerpo transparente efecto glaseado
bord transparent, corps poli mat



	Ø cm	↑ cm	ltr.
36066	22 / 14	23	4

BOTTLE COOLERS



Flaschenkühler

bottle cooler
enfriador de botella
rafraîchisseur de bouteille



doppelwandig für beste Isolierung, außen Hammerschlag-Optik

double-walled for best insulation, outside: hammered surface

doble pared para un mejor aislamiento, exterior: aspecto martillado

double paroi pour une meilleur isolation, extérieur: surface martelée

	Ø cm	↑ cm	ltr.	Farbe / Colour
36120	33	20	8	stainless
36121	33	20	8	copper-look



Präsentationsmöglichkeit
presentation examples



Wein- / Sektkühler „XL“

wine / champagne bowl
cubitera para vino y cava
seau à vin ou champagne



gehämmerte Oberfläche, mit 2 seitlichen Eingriffen

hammered surface, with 2 handles on the side

superficie martillada, con 2 asas

surface martelée, avec 2 poignées

	cm	↑ cm	ltr.	Farbe / Colour
36111	30 x 23,5	23	7	copper-look
36112	30 x 23,5	23	7	gunmetal-look



Wein- / Sektkühler „LARGE“

wine / champagne bowl
cubitera para vino y cava
seau à vin ou champagne



gehämmerte Oberfläche, mit 2 seitlichen Eingriffen, für 1-2 Flaschen

hammered surface, with 2 handles on the side, for 1-2 bottles

superficie martillada, con 2 asas, para 1-2 botellas

surface martelée, avec 2 poignées, pour 1-2 bouteilles

	cm	↑ cm	ltr.	Farbe / Colour
36108	25,5 x 19	20	3,9	copper-look
36109	25,5 x 19	20	3,9	gunmetal-look



Wein- / Sektkühler „SMALL“

wine / champagne bowl
cubitera para vino y cava
seau à vin ou champagne



gehämmerte Oberfläche, für 1 Flasche

hammered surface, for 1 bottle

superficie martillada, para 1 botella

surface martelée, pour 1 bouteille

	cm	↑ cm	ltr.	Farbe / Colour
36106	20,5 x 14	17	2,1	copper-look
36107	20,5 x 14	17	2,1	gunmetal-look



Ständer für Wein- / Sektkühler

stand for wine / champagne bowl
pie porta champañera / vino
pied pour seau à champagne / vin



hochglanzpoliert, schwerer standsicherer Fuß, Innendurchmesser der Schale Ø 17,5 cm
mirror polished, heavy foot, inner bowl Ø 17,5 cm
acabado pulido efecto brillante, bol interior de Ø 17,5 cm
brillant, intérieur support Ø 17,5 cm

	Ø cm	↑ cm
36069	17,5 / 26,5	73



Wein- / Sektkühler no. 36028
wine / champagne bowl no. 36028
cubitera para vino y cava no. 36028
seau à vin ou champagne no. 36028



Ständer für Wein- / Sektkühler

stand for wine / champagne bowl
pie porta champañera / vino
pied pour seau à champagne / vin



hochglanzpoliert, schwerer standsicherer Fuß, Innendurchmesser der Schale Ø 15 cm
mirror polished, heavy foot, inner bowl Ø 15 cm
acabado pulido efecto brillante, bol interior de Ø 15 cm
brillant, intérieur support Ø 15 cm

	Ø cm	↑ cm
36068	15 / 28	68



Ständer für Wein- / Sektkühler

stand for wine / champagne bowl
pie porta champañera / vino
pied pour seau à champagne / vin



schwarz matt, schwerer standsicherer Fuß, Innendurchmesser der Schale Ø 15 cm
black matt, heavy stable foot, inner bowl Ø 15 cm
negro mate, pie pesado y estable, bol interior de Ø 15 cm
noir mat, pied lourd et stable, intérieur support Ø 15 cm

	Ø cm	↑ cm
36116	19,5 / 26,5	71,5

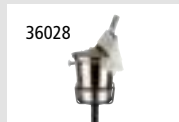
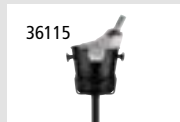

Tischhalterung für Sektkühler

champagne bucket table holder
soporte champañera universal
porte-seau à champagne



aus 8 mm starkem Stahldraht, passen zu allen lieferbaren Sektkühlern, innen Ø-Ring: 18 cm
8 mm chrome plated wire, suitable for all available champagne buckets, inner ring Ø 18 cm
alambre cromado 8 mm, para todas las champañeras, anillo interior Ø 18 cm
fil chromé 8 mm, pour tous les seaux à champagne, anneau intérieur Ø 18 cm

	cm	↑ cm
30332	49 x 20	17

BOTTLE COOLERS



Flaschenkühler

bottle cooler
enfriador de botellas
rafraîchisseur de bouteilles

doppelwandig für beste Isolierung, außen hochglanzpoliert, innen matt poliert

double wall cooler keeps the temp. for a long time, outs. mirror polished, inside matt polished
champañera inox de doble pared, interior pulido mate, exterior pulido brillante
seau inox double paroi, maintient le froid plus longt., intérieur poli mat, extérieur poli brillant



	Ø cm	↑ cm	ltr.
36077	31	19	10



Champagnerkühler

champagne bowl
cubo champañera
seau à champagne

hochglanzpoliert, doppelwandig für beste Isolierung

mirror polished, double wall cooler keeps the temp. for a long time
pulido brillante con champañera inox de doble pared
poli brillant, double paroi, maintient le froid plus longtemps



	Ø cm	↑ cm	ltr.
36044	44 / 25	24	10,5



Champagnerkühler

champagne bowl
cubo champañera
seau à champagne

hochglanzpoliert

mirror polished
pulido brillante
poli brillant



	Ø cm	↑ cm	ltr.
36045	40,5 / 27,5	22,5	13,5



Champagnerkühler

champagne bowl
cubo champañera
seau à champagne

hochglanzpoliert, Rand matt poliert

mirror polished, edge matt polished
pulido brillante, borde pulido mate
poli brillant, bord poli mat



	Ø cm	↑ cm	ltr.
36046	45 / 21	23	12



Flaschenkühler „BIG BOWL“

bottle cooler
enfriador de botella
rafraîchisseur de bouteille



gehämmerte Oberfläche, innen matt poliert, herausnehmbarer Tropfeinsatz

hammered surface, inside matt polished, removable drip tray
superficie martillada, interior pulido mate, bandeja de goteo extraíble
surface martelée, intérieur poli mat, bac d'égouttage amovible

	Ø cm	↑ cm	ltr.
36130	37	23	8



herausnehmbarer
Tropfeinsatz
removable drip tray

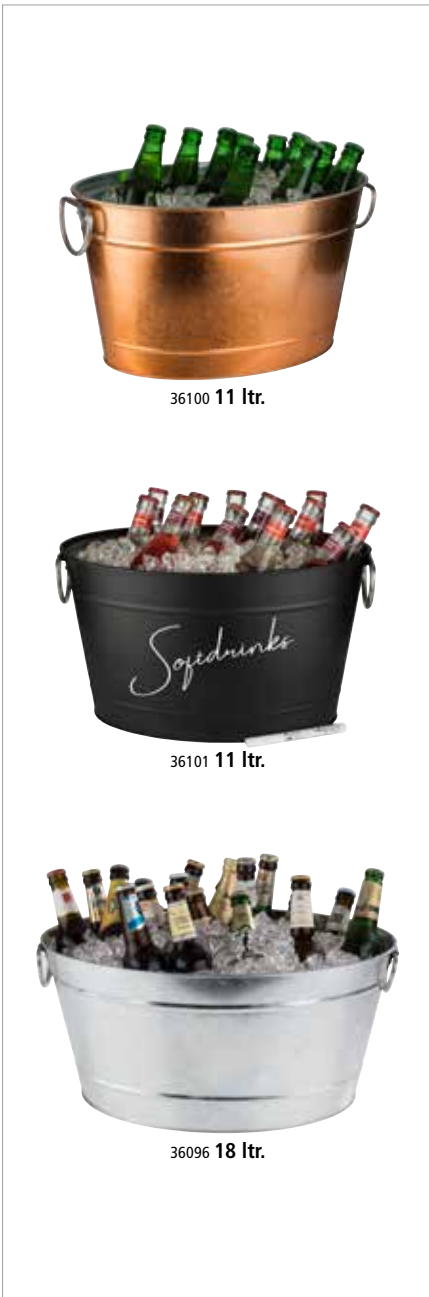

36100 11 ltr.

36101 11 ltr.

36096 18 ltr.

Getränkewanne „TIN“

beverage tub
barreño botellines
bassine à glace



Metall verzinkt, mit Kunststoffeinsatz
galvanised metal, with plastic insert
metal galvanizado, con inserto de plástico
métal galvanisé, avec insert en plastique

	cm	↑ cm	ltr.	Farbe / Colour
36100	40 x 28	22	11	copper-look
36101	40 x 28	22	11	black-metal-look
36095	40 x 28	22	11	metal-look
36096	50 x 23	23	18	metal-look



mit Kunststoffeinsatz
with plastic insert
con inserto de plástico
avec insert en plastique



71490

Kreidestift zum
Beschriften | chalk
marker for writing
S. 304

BOTTLE COOLERS



Wein- / Sektkühler

wine / champagne bowl
cubitera para vino y cava
seau à vin ou champagne

glasklar, für bis zu 6 Flaschen geeignet
transparent, suitable for up to 6 bottles
transparente, para máximo 6 botellas
transparent, maxi 6 bouteilles



	cm	↑ cm	ltr.
36057	47 x 28	23	10



Wein- / Sektkühler

wine / champagne bowl
cubitera para vino y cava
seau à vin ou champagne

mit seitlichen Griffen, transparent
with lateral handles, transparent
con asas laterales
avec poignées latérales



	cm	↑ cm	ltr.
36087	32 x 21,5	24,5	7



36048

Wein- / Sektkühler

wine / champagne bowl
cubitera para vino y cava
seau à vin ou champagne

mit 2 seitlichen Eingriffen
with 2 handles on the side
con 2 asas
avec 2 poignées



	cm	↑ cm	ltr.
36048	35 x 27	25,5	6
36052	27 x 20	21	3



36054

Wein- / Sektkühler

wine / champagne bowl
cubitera para vino y cava
seau à vin ou champagne

mit 2 seitlichen Eingriffen
with 2 handles on the side
con 2 asas
avec 2 poignées



	cm	↑ cm	ltr.
36054	35 x 27	25,5	6
36053	27 x 20	21,0	3



Wein- / Sektkühler
 wine / champagne bowl
 cubitera para vino y cava
 seau à vin ou champagne
glasklar, für zwei Flaschen
 clear, for two bottles
 transparente, para 2 botellas
 transparent, pour 2 bouteilles



	cm	↑ cm	ltr.
36056	30,5 x 21,5	26	4



Flaschenkühler
 bottle cooler
 enfriador de botella
 rafraîchisseur de bouteille



transparent, doppelwandig für beste Isolierung, mit Chromrand
 transparent, double wall cooler keeps the temperature for a long time, with chrome edg
 transpar., doble pared mantiene la temperaruta por largo tiempo, borde superior cromado
 transparent, bord chromé brillant, double paroi pour maintien en température

	Ø cm	↑ cm	Farbe / Colour
36032	12 / 10	23	
36034	12 / 10	23	



Flaschenkühler „PURE“
 bottle cooler
 enfriador de botella
 rafraîchisseur de bouteille



doppelwandig für beste Isolierung, glasklar
 double wall cooler keeps the temperature for a long time, clear
 doble pared mantiene la temperaruta por largo tiempo, transparente
 double paroi pour maintien en température, transparent

	Ø cm	↑ cm
36063	13,5 / 10,5	23
36062	13,5 / 10,5	23

BOTTLE COOLERS



Flaschenkühler „GOLD“

bottle cooler
enfriador de botella
rafraîchisseur de bouteille



Hammerschlag-Optik, doppelwandig für beste Isolierung, für 0,7 - 1,5 Liter-Flaschen

hammered look, double-walled for best insulation, for 0,7 - 1,5 ltr.-bottles
martillado, doble pared para un mejor aislamiento, para botellas de 0,7 a 1,5 L.
martelé, double paroi pour une isolation optimale, pour bouteilles de 0,7 à 1,5 L.

	Ø cm	↑ cm	Farbe / Colour
36128	12 / 10	20	



Flaschenkühler „COPPER“

bottle cooler
enfriador de botella
rafraîchisseur de bouteille



Hammerschlag-Optik, doppelwandig für beste Isolierung, für 0,7 - 1,5 Liter-Flaschen

double wall cooler keeps the temperature for a long time, hammered look, for 0,7 - 1,5 ltr. bottles
doble pared para mantener el frío largo tiempo, para botellas de 0,7 - 1,5 ltr.
double paroi pour une meilleure conservation de la température, pour bouteilles de 0,7 à 1,5 l.

	Ø cm	↑ cm	Farbe / Colour
36074	12 / 10	20	



Flaschenkühler

bottle cooler
enfriador de botella
rafraîchisseur de bouteille



doppelwandig für beste Isolierung, für 0,7 - 1,5 Liter-Flaschen

double wall cooler keeps the temperature for a long time, for 0,7 - 1,5 ltr. bottles
con doble pared para mantener el frío largo tiempo, para botellas de 0,7 - 1,5 ltr.
double paroi pour une meilleure conservation de la température, pour bouteilles de 0,7 à 1,5 l.

	Ø cm	↑ cm	Farbe / Colour
36125	12 / 10	20	copper red
36126	12 / 10	20	blue
36127	12 / 10	20	black



Flaschenkühler „WAIST“

bottle cooler
enfriador de botella
rafraîchisseur de bouteille

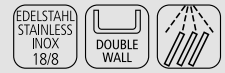

hochglanzpoliert, doppelwandig für beste Isolierung, für 0,7 - 1,5 Liter-Flaschen
mirror polished, double-walled for best insulation, for 0,7 - 1,5 ltr.-bottles
poli brillante, doble pared para un mejor aislamiento, para botellas de 0,7 a 1,5 L.
pulido brillante, double paroi pour une isolation optimale, pour bouteilles de 0,7 à 1,5 L.

	Ø cm	↑ cm	Farbe / Colour
36129	13 / 10	19	■



Flaschenkühler

bottle cooler
enfriador de botella
rafraîchisseur de bouteille

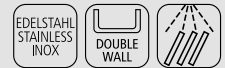

matt poliert, doppelwandig für beste Isolierung, für 0,7 - 1,5 Liter-Flaschen
matt polished, double wall cooler keeps the temperature for a long time, for 0,7 - 1,5 ltr. bottles
pulido mate con doble pared para mantener el frio largo tiempo, para botellas de 0,7 - 1,5 ltr.
poli mat, double paroi pour une meilleure conservation de la température, pour bouteilles de 0,7 à 1,5 l.

	Ø cm	↑ cm
36038	12,5 / 10	19



Flaschenkühler

bottle cooler
enfriador de botella
rafraîchisseur de bouteille



matt poliert, doppelwandig für beste Isolierung, für 0,7 - 1,5 Liter-Flaschen
matt polished, double wall cooler keeps the temperature for a long time, for 0,7 - 1,5 ltr. bottles
pulido mate, doble pared para mantener el frio largo tiempo, para botellas de 0,7 - 1,5 ltr.
poli mat, double paroi pour une meilleure conservation de la température, pour bouteilles de 0,7 à 1,5 l.

	Ø cm	↑ cm
36030	12 / 10	20



Flaschenkühler „FROSTFIRE“

bottle cooler
enfriador de botella
rafraîchisseur de bouteille



Antihafbeschichtung / non stick coating / antiadherente / revêtement anti-adhésif

	Ø cm	↑ cm	ltr.	Farbe / Colour
36140	11,5 / 11	15	1,5	■ black/silver



auch als Dressingtopf verwendbar
also usable as a dressing pot

BOTTLE COOLERS



Flaschenkühler „ELEMENT“

bottle cooler
enfriador de botella
rafraîchisseur de bouteille

möbelschonende Unterseite
non-scratching undersurface
base anti rayaduras
base revêtement antirayures



	Ø cm	↑ cm	Farbe / Colour
36131	12 / 10	19	



Flaschenkühler „ELEMENT“

bottle cooler
enfriador de botella
rafraîchisseur de bouteille

Beton, geriffelte Oberfläche, möbelschonende Unterseite
concrete, ribbed surface, non-scratching undersurface
hormigón, superficie ranurada, base anti rayaduras
béton, surface rainurée, base revêtement antirayures



	Ø cm	↑ cm	Farbe / Colour
36122	13 / 10	19,5	white
36123	13 / 10	19,5	concrete
36124	13 / 10	19,5	green



Oberflächenansicht
structural view



Flaschenkühler „ELEMENT“

bottle cooler
enfriador de botella
rafraîchisseur de bouteille

Beton, möbelschonende Unterseite
concrete, non-scratching undersurface
hormigón, base anti rayaduras
béton, base revêtement antirayures



	Ø cm	↑ cm	Farbe / Colour
36104	12 / 10	19	rose
36105	12 / 10	19	green



Flaschenkühler „ELEMENT“

bottle cooler
enfriador de botella
rafraîchisseur de bouteille

Beton, möbelschonende Unterseite
concrete, non-scratching undersurface
hormigón, base anti rayaduras
béton, base revêtement antirayures



	Ø cm	↑ cm	Farbe / Colour
36090	12 / 10	19	concrete
36099	12 / 10	19	black



Pitcher
pitcher
jarra
pichet



	Ø cm	↑ cm	ltr.
93105	13	21	1,5



einfaches Eingießen
easy pouring



93091 1,5 ltr.

Pitcher
pitcher
jarra
pichet



	Ø cm	↑ cm	ltr.
93090	12,5	17,5	1,0
93091	13,5	20,0	1,5

passende Deckel / fitting lids / tapa adecuadas / couvercles appropriées

	cm	↑ cm	fits to
93092	13,0	1,5	93090
93093	14,0	1,5	93091



Deckel mit Klappe
lid with flap



einfaches Eingießen
easy pouring



stapelbar
stackable



Kühlmanschette „CHAMPAGNE“

cool collar
funda de frío
housse isotherme



für Sekt- / Champagnerflaschen, einfach im Gefrierfach einfrieren, komplette Flasche wird in 5 Min. auf angenehme Trinktemperatur gekühlt, außen reißfestes Stoffgewebe, innen Kunststoff mit Kühlgel gefüllt, unbegrenzt wiederverwendbar

for bottles of champagne, simply to freeze in the freezer, complete bottles will be cooled down in only 5 minutes, tearproof cloth outside, plastic filled with gel inside, unlimited reusable
para botellas de cava o champán simplemente congelándola en el congelador, la botella entera se enfriará en 5 minutos, funda de plástico muy robusta, rellena con un gel congelante reutilizable ilimitadamente

pour bouteilles de vin ou champagne, la housse est préalablement stockée au congélateur, où elle accumule le froid, ensuite elle refroidit une bouteille en quelques minutes, plastique résistant, contient un liquide congelant, à réutiliser de façon illimitée

	Ø cm	↑ cm
36075	11	18



Weinflaschenhalter
winebottle-stand
soporte para botella de vino
porte-bouteille



	cm	↑ cm
30333	22 x 6	20,5



BEVERAGE DISPENSERS



7 ltr.

10853

Getränkespender „INDUSTRIAL“

beverage dispenser
dispensador de bebidas
distributeur de boissons



Behälter aus Glas, Zapfhahn aus Edelstahl, Fuß und Deckel aus Metall, schwarz, Antirutschmatte aus Silikon

glass container, stainless steel tap, base and lid in black metal, silicone non-slip mat
recipiente de vidrio, grifo de acero inoxidable, base y tapa de metal negro, tapete antideslizante de silicona

réceptien en verre, robinet en acier inox, pied et couvercle en métal noir, tapis antidérapant en silicone

	Ø cm	↑ cm	ltr.	
10450	20	45	7	inkl. Gestell / incl. stand



Antirutschmatte aus Silikon
silicone anti-slip mat



7 ltr.

Getränkespender „URBAN“

beverage dispenser
dispensador de bebidas
distributeur de boissons



Behälter aus Glas, Zapfhahn aus Edelstahl, Fuß und Deckel aus Metall, schwarz, Antirutschmatte aus Silikon

glass container, stainless steel tap, base and lid in black metal, silicone non-slip mat
recipiente de vidrio, grifo de acero inoxidable, base y tapa de metal negro, tapete antideslizante de silicona

réceptien en verre, robinet en acier inox, pied et couvercle en métal noir, tapis antidérapant en silicone

	Ø cm	↑ cm	ltr.	
10451	22	45	7	inkl. Gestell / incl. stand



Antirutschmatte aus Silikon
silicone anti-slip mat



Eiswasserröhre

ice cube cooling tube
tubo enfriador para cubitos
tube pour glaçons



	Ø cm	↑ cm	passend für Getränkenspender / fits to drink dispenser
10849	11	24	10400, 10403, 10450, 10451, 10855



7 ltr.

Getränkspender „ELEMENT“

beverage dispenser
dispensador de bebidas
distributeur de boissons



Behälter aus Glas, Zapfhahn aus Edelstahl, Fuß und Deckel aus Beton

glass container, stainless steel tap, stand and lid made of concrete
recipiente de vidrio, grifo de acero inoxidable, soporte y tapa de hormigón
récipient en verre, robinet en acier inox, support et couvercle en béton

	Ø cm	↑ cm	ltr.	
10400	22	45	7	inkl. Gestell / incl. stand



7 ltr.

Getränkspender „OLD FASHIONED“

beverage dispenser
dispensador de bebidas
distributeur de boissons



Behälter aus Glas, Zapfhahn aus Edelstahl, Gestell schwarz

glass container, stainless steel tap, black stand
recipiente de vidrio, grifo de acero inoxidable, soporte negro
récipient en verre, robinet en acier inox, support noir

	Ø cm	↑ cm	ltr.	
10409	27	50,5	7	inkl. Gestell / incl. stand

Ersatz-Gestell / stand / soporte de recambio / support de remplacement

	Ø cm	↑ cm	
10410	27	31,5	

Ersatz-Glas / replacement glass / cristal de recambio / vitre de rechange

	Ø cm	↑ cm	ltr.
10411	19	36,5	7

Ersatz-Zapfhahn 10409 / replacement tap for 10409

10718



7 ltr.

Getränkspender „ASIA“

beverage dispenser
dispensador de bebidas
distributeur de boissons



Behälter aus Glas, Zapfhahn aus Edelstahl, Fuß und Deckel aus Holz

glass container, stainless steel tap, wooden stand and lid
recipiente de vidrio, grifo de acero inoxidable, soporte y tapa de madera
récipient en verre, robinet en acier inox, support et couvercle en bois

	Ø cm	↑ cm	ltr.	
10403	24,5	45,5	7	inkl. Gestell / incl. stand

Ersatz-Fuß / base / soporte de recambio / support de remplacement

	Ø cm	↑ cm	
10404	24,5	15	

Ersatz-Deckel / replacement lid / tapa de recambio / couvercle de rechange

	Ø cm	↑ cm	
10405	14,0	5	



10841

Tropfschale, 2-teilig

drip tray, 2 pcs.
aros anti-goteo, set de 2
anneaux coupe-gouttes, set de 2



	Ø cm	↑ cm	Farbe / Colour
10851	9,5	1,5	white
10853	9,5	1,5	anthracite
10841 <small>NEW</small>	9,5	1,5	black

NEW

PERFECTION



NEW



Sektglas „PERFECTION“
 champagne glass
 copa de champán
 flûte à champagne



	Ø cm	↑ cm	ltr.	VE / unit
10540	5	23	0,19	12

NEW



Weißweinglas „PERFECTION“
 white wine glass
 copa de vino blanco
 verre à vin blanc



	Ø cm	↑ cm	ltr.	VE / unit
10541	8	21,5	0,32	12

NEW



Rotweinglas „PERFECTION“
 red wine glass
 copa de vino tinto
 verre à vin rouge



	Ø cm	↑ cm	ltr.	VE / unit
10542	10,5	21	0,6	12

LINEA

5 SIZES
5 COLOURS



UNZERBRECHLICH
UNBREAKABLE



10577
0,30 ltr.



10585
0,15 ltr.



10561
0,22 ltr.



10573
0,40 ltr.



10569
0,50 ltr.

Trinkbecher „LINEA“
drinking cups
vasos
gobelets



Die elegant facettierte Bechergläser LINEA lassen sich vielseitig im Bar-, Club-, Pool- und Buffetbereich verwenden. Sowohl die transparenten als auch die farbigen Modelle setzen in jedem Ambiente edle Akzente. Dank ihrer perfekten Stapelbarkeit werden sie platzsparend aufbewahrt und transportiert.

The elegantly faceted tumbler glasses LINEA can be used in a variety of ways in the bar, club, pool and buffet areas. Both the transparent and coloured models set elegant accents in any ambience. Thanks to their perfect stackability, they are space-saving to store and transport.

Los vasos LINEA, elegantemente facetados, pueden utilizarse de diversas maneras en el bar, el club, la piscina y el buffet. Tanto los modelos transparentes como los de color ponen elegantes acentos en cualquier ambiente. Gracias a su perfecta apilabilidad, ahorran espacio para su almacenamiento y transporte.

Les verres LINEA élégamment facetés peuvent être utilisés de manière polyvalente dans les bars, les clubs, les piscines et les buffets. Les modèles transparents et colorés apportent une touche de noblesse dans chaque ambiance. Grâce à leur parfaite empilabilité, ils se rangent et se transportent avec un minimum d'encombrement.

	Ø cm	↑ cm	ltr.	VE	Farbe / Colour
10560	6,5	8,0	0,15	48	crystal clear
10561	8,5	8,0	0,22	48	crystal clear
10562	8,5	10,0	0,30	48	crystal clear
10563	8,5	12,0	0,40	48	crystal clear
10564	8,5	15,0	0,50	48	crystal clear
10565	6,5	8,0	0,15	48	french grey
10566	8,5	8,0	0,22	48	french grey
10567	8,5	10,0	0,30	48	french grey
10568	8,5	12,0	0,40	48	french grey
10569	8,5	15,0	0,50	48	french grey
10570	6,5	8,0	0,15	48	light green
10571	8,5	8,0	0,22	48	light green
10572	8,5	10,0	0,30	48	light green
10573	8,5	12,0	0,40	48	light green
10574	8,5	15,0	0,50	48	light green
10575	6,5	8,0	0,15	48	light pink
10576	8,5	8,0	0,22	48	light pink
10577	8,5	10,0	0,30	48	light pink
10578	8,5	12,0	0,40	48	light pink
10579	8,5	15,0	0,50	48	light pink
10585	6,5	8,0	0,15	48	light blue
10586	8,5	8,0	0,22	48	light blue
10587	8,5	10,0	0,30	48	light blue
10588	8,5	12,0	0,40	48	light blue
10589	8,5	15,0	0,50	48	light blue

CRYSTAL



Trinkbecher „CRYSTAL“

drinking cups

vasos

gobelets

Kristallglas-Optik, vielseitig einsetzbar, robustes, unzerbrechliches Material, ideal in sensiblen Bereichen wie Pool, Spa, Beach und Wellness einzusetzen

crystal-glass-look, can be used in versatile ways, a solide and unbreakable material, ideal to be used at pool, spa, beach and wellness areas

aspecto vidrio, se pueden utilizar de muchas maneras diferentes, material sólido e irrompible, ideal para el uso en áreas como piscina, spa, playa y bienestar

ressemble à un verre de cristal, peuvent être utilisés de différentes façons, matériau robuste et incassable, idéal pour une utilisation dans des zones comme la piscine, le spa, la plage et le bien-être



	Ø cm	↑ cm	ltr.	VE	Farbe / Colour
10500	7,0	9,5	0,15	48	crystal clear
10503	7,5	11,0	0,20	48	crystal clear
10501	8,0	12,5	0,30	48	crystal clear
10504	8,5	14,0	0,40	48	crystal clear
10502	9,0	15,5	0,50	48	crystal clear
	Ø cm	↑ cm	ltr.	VE	Farbe / Colour
10513	7,0	9,5	0,15	48	blue sky
10516	7,5	11,0	0,20	48	blue sky
10514	8,0	12,5	0,30	48	blue sky
10517	8,5	14,0	0,40	48	blue sky
10515	9,0	15,5	0,50	48	blue sky



**5 SIZES
2 COLOURS**



**UNZERBRECHLICH
UNBREAKABLE**

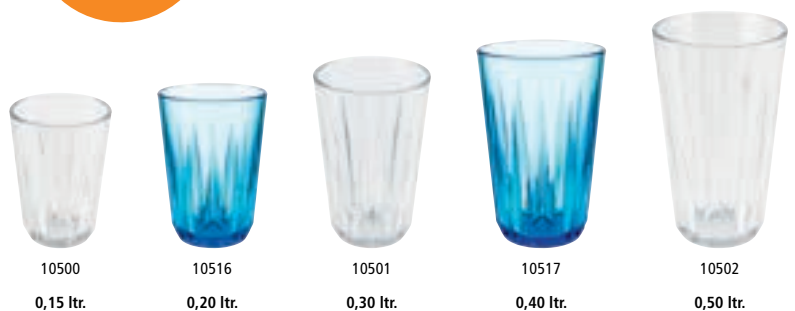

10500
0,15 ltr.















10516
0,20 ltr.

10501
0,30 ltr.

10517
0,40 ltr.

10502
0,50 ltr.



	Ø cm	↑ cm	ltr.	VE	Farbe / Colour
10510	7,0	9,5	0,15	48	 red star
10511	8,0	12,5	0,30	48	 red star
10512	9,0	15,5	0,50	48	 red star
	Ø cm	↑ cm	ltr.	VE	Farbe / Colour
10525	7,0	9,5	0,15	48	 french grey
10526	8,0	12,5	0,30	48	 french grey
10527	9,0	15,5	0,50	48	 french grey
	Ø cm	↑ cm	ltr.	VE	Farbe / Colour
10528	7,0	9,5	0,15	48	 purple
10529	8,0	12,5	0,30	48	 purple
10530	9,0	15,5	0,50	48	 purple
	Ø cm	↑ cm	ltr.	VE	Farbe / Colour
10531	7,0	9,5	0,15	48	 apricot
10532	8,0	12,5	0,30	48	 apricot
10533	9,0	15,5	0,50	48	 apricot
	Ø cm	↑ cm	ltr.	VE	Farbe / Colour
10534	7,0	9,5	0,15	48	 green
10535	8,0	12,5	0,30	48	 green
10536	9,0	15,5	0,50	48	 green



UNZERBRECHLICH
UNBREAKABLE



3 SIZES
5 COLOURS



Trinkglas „BEACH“
drinking glass
vaso
verre



vielseitig einsetzbar, robustes, unzerbrechliches Material
can be used in versatile ways, a solide and unbreakable material
se pueden utilizar de muchas maneras diferentes, material sólido e irrompible
peuvent être utilisés de différentes façons, matériau robuste et incassable

	Ø cm	↑ cm	ltr.	VE	Farbe / Colour
10509	8,5	13,5	0,30	48	
10505	8,5	13,5	0,30	48	



MOSCOW MULE



Flaschenkühler „MOSCOW MULE“

bottle cooler
enfriador de botellas
rafraîchisseur de bouteilles

Edelstahl-Flaschenkühler, Antik-Kupfer-Look
stainless steel cooler, copper antique look
enfriador de acero inoxidable, cobre estilo antigua
rafraîchisseur en acier inox, cuivre style antique



	Ø cm	↑ cm	ltr.	Farbe / Colour
93330	20	21	5	 copper-antique-hammered



Becher „MOSCOW MULE“, 2er-Set

barrel copper mug, 2 pcs.
taza, set de 2
gobelet, set de 2

Edelstahlbecher, Antik-Kupfer-Look
stainless steel cup, copper antique look
taza de acero inoxidable, cobre estilo antiguo
gobelet en acier inox, cuivre style antique



	Ø cm	↑ cm	ltr.	Farbe / Colour
93367	9	10	0,5	 copper-antique-hammered



Becher „MOSCOW MULE“

barrel mug
taza
gobelet

Edelstahlbecher, Antik-Edelstahl-Look
stainless steel cup, stainless steel antique look
taza de acero inoxidable, acero estilo antiguo
gobelet en acier inox, acier style antique



	Ø cm	↑ cm	ltr.	Farbe / Colour
93346	9	10	0,5	 stainless-antique-hammered



Becher „MOSCOW MULE“

barrel mug
taza
gobelet

Edelstahlbecher, Antik-Edelstahl-Look

stainless steel cup, stainless antique look
taza de acero inoxidable, acero estilo antiguo
gobelet en acier inox, acier style antique



	∅ cm	↑ cm	ltr.	Farbe / Colour
93345	9	9	0,45	stainless-antique



Becher „MOSCOW MULE“

barrel copper mug
taza
gobelet

Edelstahlbecher, Antik-Kupfer-Look

stainless steel cup, copper antique look
taza de acero inoxidable, cobre estilo antiguo
gobelet en acier inox, cuivre style antique



	∅ cm	↑ cm	ltr.	Farbe / Colour
93322	9	9	0,45	copper-antique



Becher „MOSCOW MULE“

barrel copper mug
taza
gobelet

Edelstahlbecher, Kupfer-Look, hochglanzpoliert

stainless steel cup, copper look, mirror polished
taza de acero inoxidable, estilo cobre, pulido brillante
gobelet en acier inox, aspect cuivre, poli brillant



	∅ cm	↑ cm	ltr.	Farbe / Colour
93310	9	9	0,45	copper-look



Becher „MOSCOW MULE“

barrel copper mug
taza
gobelet

Edelstahlbecher, Kupfer-Look, hochglanzpoliert

stainless steel cup, copper look, mirror polished
taza de acero inoxidable, estilo cobre, pulido brillante
gobelet en acier inox, aspect cuivre, poli brillant



	∅ cm	↑ cm	ltr.	Farbe / Colour
93311	9	10	0,50	copper-hammered



Becher „MOSCOW MULE“

barrel copper mug
taza
gobelet

Edelstahlbecher, Antik-Kupfer-Look

stainless steel cup, copper look
taza de acero inoxidable, cobre estilo antiguo
gobelet en acier inox, cuivre style antique



	∅ cm	↑ cm	ltr.	Farbe / Colour
93323	9	10	0,50	copper-antique-hammered

MOSCOW MULE



Becher „MOSCOW MULE“

barrel mug
taza
gobelet

Edelstahlbecher, Antik-Edelstahl-Look

stainless steel cup, stainless antique look
taza de acero inoxidable, acero estilo antiguo
gobelet en acier inox, acier style antique



	Ø cm	↑ cm	ltr.	Farbe / Colour	
93333	9,5	10	0,50		stainless-antique

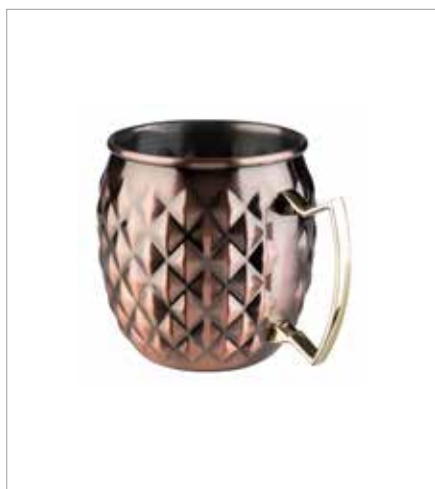

Becher „MOSCOW MULE“

barrel copper mug
taza
gobelet

Edelstahlbecher, Antik-Kupfer-Look

stainless steel cup, copper antique look
taza de acero inoxidable, cobre estilo antiguo
gobelet en acier inox, cuivre style antique



	Ø cm	↑ cm	ltr.	Farbe / Colour	
93331	9,5	10	0,50		copper-antique

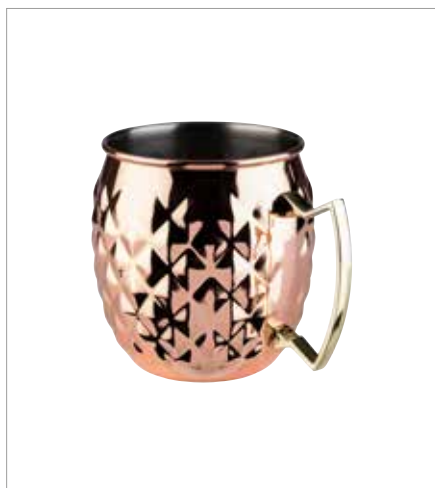

Becher „MOSCOW MULE“

barrel copper mug
taza
gobelet

Edelstahlbecher, Kupfer-Look, hochglanzpoliert

stainless steel cup, copper look, mirror polished
taza de acero inoxidable, estilo cobre, pulido brillante
gobelet en acier inox, aspect cuivre, poli brillant



	Ø cm	↑ cm	ltr.	Farbe / Colour	
93332	9,5	10	0,50		copper-look



Becher „BEER MUG“

barrel mug
taza
gobelet



	Ø cm	↑ cm	ltr.	Farbe / Colour	
93364	8,5	13	0,50		copper-antique
93365	8,5	13	0,50		stainless-antique

93364

93365

**Becher „COOL“**

barrel mug

taza

gobelet

Edelstahlbecher, Antik-Edelstahl-Look

stainless steel cup, stainless antique look

taza de acero inoxidable, acero estilo antiguo

gobelet en acier inox, acier style antique



	Ø cm	↑ cm	ltr.	Farbe / Colour	
93373	7,5	10,5	0,35		stainless-antique

**Becher „COOL“**

barrel mug

taza

gobelet

Edelstahlbecher, Kupfer-Look, hochglanzpoliert

stainless steel cup, copper look, mirror polished

taza de acero inoxidable, estilo cobre, pulido brillante

gobelet en acier inox, aspect cuivre, poli brillant



	Ø cm	↑ cm	ltr.	Farbe / Colour	
93371	7,5	10,5	0,35		copper-look

**Becher „COOL“**

barrel mug

taza

gobelet

Edelstahlbecher, Gunmetal-Look, hochglanzpoliert

stainless steel cup, gunmetal look, mirror polished

taza de acero inoxidable, estilo gunmetal, pulido brillante

gobelet en acier inox, aspect gunmetal, poli brillant



	Ø cm	↑ cm	ltr.	Farbe / Colour	
93372	7,5	10,5	0,35		gunmetal-look

**Becher „COOL“**

barrel mug

taza

gobelet

Edelstahlbecher, Regenbogen-Look

stainless steel cup, rainbow look

taza de acero inoxidable, estilo arco iris

gobelet en acier inox, look arc-en-ciel



	Ø cm	↑ cm	ltr.	Farbe / Colour	
93374	7,5	10,5	0,35		rainbow-look

**Speedshaker / Trinkbecher**

speed shaker / drinking cup

agitador rápido / vaso

speedshaker / gobelet



	Ø cm	↑ cm	ltr.
93204	8,5	13	0,5

JULEP MUGS



Becher „JULEP MUG“ barrel mug taza gobelet



	Ø cm	↑ cm	ltr.	Farbe / Colour
93336	8	11,5	0,40	copper-antique-hammered
93337	8	11,5	0,40	copper-hammered
93338	8	11,5	0,40	stainless-antique-hammered



Becher „JULEP MUG“ barrel mug taza gobelet



	Ø cm	↑ cm	ltr.	Farbe / Colour
93327	8,5	10	0,35	copper-antique
93328	8,5	10	0,35	copper-look
93329	8,5	10	0,35	stainless



Snackspender snack dispenser dispensador de snacks distributeur de snacks



Behälter aus Glas, Schraubdeckel aus Edelstahl, Öffnung oval 3,5 x 2,5 cm
glass container, stainless steel screw cap, opening oval 3,5 x 2,5 cm
recipiente de cristal, tapón de rosca de acero inoxidable, apertura ovalada 3,5 x 2,5 cm
récipient en verre, couvercle à visser en acier inox, ouverture ovale 3,5 x 2,5 cm

	Ø cm	↑ cm	ltr.	Farbe / Colour
40516	8,5	15,5	0,35	gold-look
40517	8,5	15,5	0,35	gunmetal-look



Becher „PINEAPPLE“

barrel mug
taza
gobelet

Glasbecher mit Edelstahl Deckel

glass cup with stainless steel lid

taza de cristal con tapa en acero inoxidable

gobelet en verre avec couvercle en acier inox



	Ø cm	↑ cm	ltr.
93375	8,5	17,5	0,35



Becher „PINEAPPLE“

barrel mug
taza
gobelet

Edelstahlbecher, Kupfer-Look

stainless steel cup, copper look

taza de acero inoxidable, cobre

gobelet en acier inox, cuivre



	Ø cm	↑ cm	ltr.	Farbe / Colour
93334	9	19	0,5	 copper-look



Becher „PINEAPPLE“

barrel mug
taza
gobelet

Edelstahlbecher, Gold-Look

stainless steel cup, gold look

taza de acero inoxidable, dorada

gobelet en acier inox, doré



	Ø cm	↑ cm	ltr.	Farbe / Colour
93335	9	19	0,5	 gold-look



Gläserchiene

glass rack
rack de copas
rack porte-verres



aus 6 mm Draht, Metall verchromt, Wand- und Deckenmontage möglich

6 mm chrome plated wire, can be mounted under a shelf or on the wall

alambre cromado de 6 mm, puede instalarse bajo una estantería o en la pared

fil chromé de 6 mm, à installer sous une étagère ou contre un mur



	cm	↑ cm	for glasses	Farbe / Colour
93398	29,5 x 32	6	12	 chrome
93399	29,5 x 32	6	12	 black
93400	45,0 x 32	6	20	 chrome

SHAKERS



Tin in tin Shaker

tin in tin shaker
coctelera tin in tin
shaker tin in tin

2-teiliges Set, Edelstahlbecher, mattiert

2 pieces, stainless steel cup, matt polished

set de 2, taza de acero, pulido mate

set de 2, gobelet en acier, poli mat



	Ø cm	↑ cm	ltr.
93203	9	27	0,7 / 0,5

Ersatztrinkbecher / spare drinking cup / vaso de recambio / gobelet de rechange

	Ø cm	↑ cm	ltr.
93204	8,5	13	0,5



Boston Shaker

boston shaker
coctelera boston
shaker boston

2-teiliges Set: Becher, 700 ml + Glas, 400 ml

2 pcs.: beaker, 700 ml + glass, 400 ml

set de 2: vaso coctelero, 700 ml+ vaso vidrio 400 ml

set de 2: bol mélangeur, 700 ml + bol en verre 400 ml



	Ø cm	↑ cm	ltr.	Farbe / Colour
93140	9	30	0,7 / 0,4	stainless-steel
93350	9	30	0,7 / 0,4	stainless-antique

	Ø cm	↑ cm	ltr.	Farbe / Colour
93325	9	30	0,7 / 0,4	copper-antique
93201	9	30	0,7 / 0,4	copper-look

Ersatzglas / spare glass / vaso de recambio / verre de rechange

	Ø cm	↑ cm	ltr.
93138	8,5	14,5	0,4



Boston Shaker

boston shaker
coctelera boston
shaker boston

2-teiliges Set: Becher, 700 ml, gummiert, rutschfest + Glas, 400 ml

2 pcs.: beaker, 700 ml, rubberized, anti-slip + glass, 400 ml

set de 2: vaso coctelero con goma exterior 700 ml + vaso de vidrio 400 ml

set de 2: bol mélangeur inox extérieur plastifié couleur 700 ml + bol en verre 400 ml



	Ø cm	↑ cm	ltr.	Farbe / Colour
93139	9	30	0,7	

36010
500 ml36011
700 ml**Shaker „CLASSIC“**shaker
coctelera
shaker**3-teiliges Set: Edelstahlbecher, Siebaufsatz, Deckel, hochglanzpoliert**

3 pieces: stainless steel mug, strainer, lid, mirror polished

set de 3: taza de acero inoxidable, colador, tapa, pulido brillante

set de 3: gobelet en acier inox, tamis, couvercle, poli brillant



	Ø cm	↑ cm	ltr.
36010	8,5	20	0,5
36011	9,0	23	0,7

93211
500 ml93212
700 ml**Shaker „CLASSIC“**shaker
coctelera
shaker**3-teiliges Set: Edelstahlbecher, Siebaufsatz, Deckel, Kupfer-Look, hochglanzpoliert**

3 pieces: stainless steel mug, strainer, lid, copper look, mirror polished

set de 3: taza de acero inoxidable, colador, tapa, cobre, pulido brillante

set de 3: gobelet en acier inox, tamis, couvercle, cuivre, poli brillant



	Ø cm	↑ cm	ltr.	Farbe / Colour
93211	8,5	20	0,5	 copper-look
93212	9,0	23	0,7	 copper-look

93366
700 ml93326
700 ml**Shaker „CLASSIC“**shaker
coctelera
shaker**3-teiliges Set: Edelstahlbecher, Siebaufsatz, Deckel**

3 pieces: stainless steel mug, strainer, lid

set de 3: taza de acero inoxidable, colador, tapa

set de 3: gobelet en acier inox, tamis, couvercle

	Ø cm	↑ cm	ltr.	Farbe / Colour
93366	9,0	23	0,7	 stainless-antique
93326	9,0	23	0,7	 copper-antique



700 ml

Parisian Shakershaker
coctelera
shaker**2-teiliges Set, Edelstahlbecher, mattiert**

2 pieces, stainless steel cup, matt polished

set de 2, taza de acero, pulido mate

set de 2, gobelet en acier, poli mat

	Ø cm	↑ cm	ltr.
93179	9,5	24	0,7



JIGGERS



Barmaß
jigger
medidor jigger
mesure double jigger



schnelles und genaues Abmessen von Spirituosen, mit Füllstrich
quick and exact measuring of spirits, with fill line
medida rápida y exacta de licores, con línea de llenado
mesure exact et rapide des spiritueux, avec ligne de remplissage

	Ø cm	↑ cm	ltr.	Farbe / Colour	
93351	4,5	9	2 / 4		stainless-steel-polished
93354	4,5	9	2 / 4		stainless-antique



Barmaß
jigger
medidor jigger
mesure double jigger



schnelles und genaues Abmessen von Spirituosen, mit Füllstrich
quick and exact measuring of spirits, with fill line
medida rápida y exacta de licores, con línea de llenado
mesure exact et rapide des spiritueux, avec ligne de remplissage

	Ø cm	↑ cm	ltr.	Farbe / Colour	
93353	4,5	9	2 / 4		copper-look
93352	4,5	9	2 / 4		copper-antique



Barmaß
jigger
medidor jigger
mesure double jigger



schnelles und genaues Abmessen von Spirituosen, mit Füllstrich
quick and exact measuring of spirits, with fill line
medida rápida y exacta de licores, con línea de llenado
mesure exact et rapide des spiritueux, avec ligne de remplissage

	Ø cm	↑ cm	ltr.	Farbe / Colour	
93164	4,5	9	1,5 / 2,5 / 3,5 / 5		stainless-steel-polished
93355	4,0	11	1,5 / 2,5 / 3,5 / 5		stainless-antique



Barmaß
jigger
medidor jigger
mesure double jigger



schnelles und genaues Abmessen von Spirituosen, mit Füllstrich
quick and exact measuring of spirits, with fill line
medida rápida y exacta de licores, con línea de llenado
mesure exact et rapide des spiritueux, avec ligne de remplissage

	Ø cm	↑ cm	ltr.	Farbe / Colour	
93165	4,5	9	1,5 / 2,5 / 3,5 / 5		copper-look
93324	4,0	11	1,5 / 2,5 / 3,5 / 5		copper-antique



Barmaß

jigger
medidor jigger
measure double jigger



hochglanzpoliert, schnelles und genaues Abmessen von Spirituosen, mit Füllstrich
mirror polished, quick and exact measuring of spirits, with fill line
pulido brillante, medida rápida y exacta de licores, con línea de llenado
poli miroir, mesure exact et rapide des spiritueux, avec ligne de remplissage

	∅ cm	↑ cm	cl.
93356	5	9	1 / 1,5 / 2 / 3 / 4 / 6



Barmaß

jigger
medidor jigger
measure double jigger



hochglanzpoliert, schnelles und genaues Abmessen von Spirituosen, mit Füllstrich
mirror polished, quick and exact measuring of spirits, with fill line
pulido brillante, medida rápida y exacta de licores, con línea de llenado
poli miroir, mesure exact et rapide des spiritueux, avec ligne de remplissage

	∅ cm	↑ cm	cl.
93357	3,5	7,5	3 / 5



Barmaß

jigger
medidor jigger
measure double jigger



hochglanzpoliert, schnelles und genaues Abmessen von Spirituosen, mit Füllstrich
mirror polished, quick and exact measuring of spirits, with fill line
pulido brillante, medida rápida y exacta de licores, con línea de llenado
poli miroir, mesure exact et rapide des spiritueux, avec ligne de remplissage

	∅ cm	↑ cm	cl
93121	4,0 / 3,5	8,5	2 / 4
93112	4,5 / 4,0	8,5	2,5 / 5



Barmaß

jigger
medidor jigger
measure double jigger



hochglanzpoliert, schnelles und genaues Abmessen von Spirituosen, mit Füllstrich
mirror polished, quick and exact measuring of spirits, with fill line
pulido brillante, medida rápida y exacta de licores, con línea de llenado
poli miroir, mesure exact et rapide des spiritueux, avec ligne de remplissage

	∅ cm	↑ cm	cl
93120	4,5 / 3,5	7,0	2 / 4



Barmaß

jigger
medidor jigger
measure double jigger



hochglanzpoliert, schnelles und genaues Abmessen von Spirituosen, mit Füllstrich
mirror polished, quick and exact measuring of spirits, with fill line
pulido brillante, medida rápida y exacta de licores, con línea de llenado
poli miroir, mesure exact et rapide des spiritueux, avec ligne de remplissage

	∅ cm	↑ cm	cl
93116	6 / 5	6	2 / 4



MUDDLERS



Stößel
muddler
mortero
pilon muddler



mit griffigem Ende, zum Auspressen von Früchten und Zerstoßen von Würfelzucker
with handy end, to press fruits or pound lump sugar
con un acabado en relieve para exprimir frutas y machacar azucarillos
avec relief grillagé pour presser les fruits ou le sucre en morceaux

	Ø cm	→ cm		Farbe / Colour	€
93358	3,5	20,5	stainless steel		
93360	3,5	20,5	copper-look		
93361	3,5	20,5	stainless-antique		
93362	3,5	20,5	copper-antique		



Stößel
muddler
mortero
pilon muddler



grober Stößel, zum Auspressen von Früchten und Zerstoßen von Würfelzucker
coarse notched, to press fruits or pound lump sugar
mortero grueso con muescas para exprimir frutas y machacar azucarillos
muddler grand format avec bout relief étoile pour presser les fruits ou le sucre en morceaux

	Ø cm	→ cm	Farbe / Colour
93181	2,5	21	
93182	4	24	



Stößel
muddler
mortero
pilon muddler



aus Buchenholz, mit griffigem Ende, zum Auspressen von Früchten und Zerstoßen von Würfelzucker
beech wood, with handy end, to press fruits or pound lump sugar
madera de haya, acabado relieve para prensar frutas o azucar
bois de hêtre, avec relief grillagé pour presser les fruits ou le sucre en morceaux

	Ø cm	→ cm	Farbe / Colour
93180	2,5	21	

BAR SPOONS

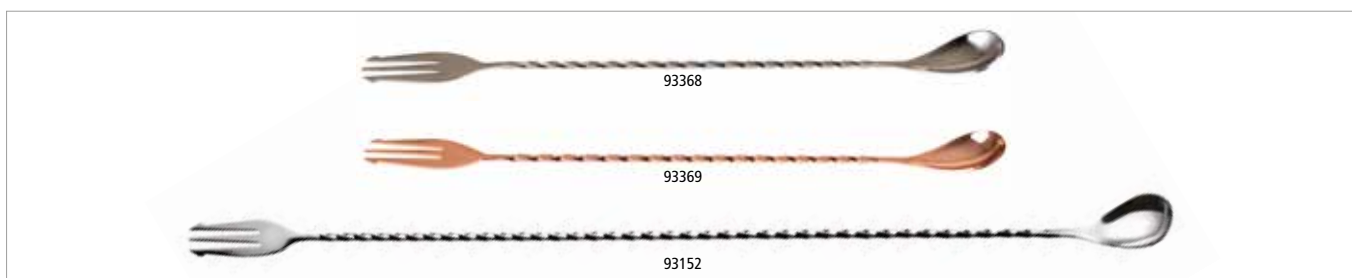

Barlöffel / -gabel
bar spoon
cucharilla de cóctel trident
cuillère de bar trident



	→ cm	Farbe / Colour	
93368	30		stainless steel
93369	30		copper-look
93152	50		stainless steel

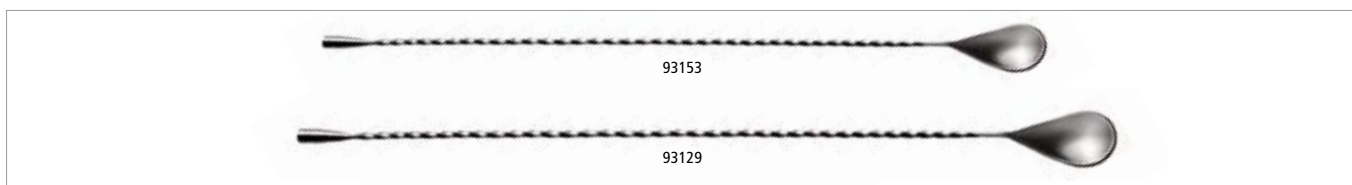

Barlöffel
bar spoon
cucharilla de cóctel
cuillère à cocktail



	→ cm	Farbe / Colour	
93153	40		stainless steel
93129	44		stainless steel



Barlöffel
bar spoon
cucharilla de cóctel
cuillère à cocktail



	→ cm	Farbe / Colour	
93134	27		stainless steel
93034	27		copper-look



BAR STRAINERS



Barsieb

bar strainer
colador de cóctel
tamis cocktail



Spiralfeder hält Eiswürfel beim Abseihen zurück, Feder kann zur Reinigung entnommen werden, passend für alle Gläser und Shaker

coil spring keeps ice cubes in shaker, spring can be taken off for cleaning, suitable for all glasses and shakers

con muelle para mantener los cubitos en la coctelera, el muelle se desmonta para limpiar, se adapta a todos los tipos de vasos y cocteleras

avec ressort pour garder les glaçons dans le shaker, ressort démontable pour lavage, s'adapte à tous types de verres mélangeurs et shakers

	Ø cm	Griff / handle cm	Farbe / Colour	
93347	9	9		copper-antique
93348	9	9		copper-look
93349	9	9		stainless-antique
93312	9	9		stainless steel



Einhandgebrauch
single-handed use



Barsieb

bar strainer
colador de cóctel
tamis cocktail



hochglanzpoliert, Spiralfeder hält Eiswürfel beim Abseihen zurück, Feder kann zur Reinigung entnommen werden, passend für alle Gläser und Shaker

mirror polished, coil spring keeps ice cubes in shaker, spring can be taken off for cleaning, suitable for all glasses and shakers

pulido brillante, con muelle para mantener los cubitos en la coctelera, el muelle se desmonta para limpiar, se adapta a todos los tipos de vasos y cocteleras

poli brillant, avec ressort pour garder les glaçons dans le shaker, ressort démontable pour lavage, s'adapte à tous types de verres mélangeurs et shakers

	Ø cm	Griff / handle cm
93300	8	6



Julep Barsieb „PRO“

julep strainer
colador de cóctel
tamis cocktail



hochglanzpoliert, Einhandgebrauch

mirror polished, single-handed use

pulido brillante, uso con una sola mano

poli brillant, utilisation d'une seule main



	Ø cm	Griff / handle cm
93313	7,5	9



Barsieb
bar strainer
colador de cóctel
tamis cocktail



	Ø cm	↑ cm	Griff / handle cm
93318	8,5	5	11,5



Schneidebrett „BAR“
cutting board
table de corte
planche à découper



HDPE, mit Safrinne, mit Antirutschfüßchen
HDPE, with juice groove and non-slip feet
HDPE, con ranura para líquidos y pies antideslizantes
HDPE, avec rigole et pieds antidérapants

	cm	↑ cm
93306	30 x 20	2
93307	50 x 30	2



Cocktailmesser „TOOLTIME“
bar knife
cuchillo para cóctel
couteau cocktail



mit 2 Zinken zum Aufspießen von Zitrusseiben
with 2 prongs to pick up slices of lemon
con 2 dientes para pinchar las rodajas de limón, etc.
avec 2 dents pour les rondelles de citron et autres décorations

	→ cm
88846	21



Dekoriermesser „TOOLTIME“
decorating knife „cannelé“
cuchillo acanalador
couteau canneléur



gezahnte Klinge aus geschärftem Edelstahl
serrated sharpened blade, stainless steel
hoja de sierra afilada, acero inoxidable
lame inox microdentée

	→ cm
88843	19



Zutatenbehälter
condiment holder
dispensador de especias
boîte à fruits et ingrédients



500 ml Inhalt pro Fach, 6 Fächer, inklusive Deckel (gefrostet) zur Lagerung
6 chambers á 500 ml, including lid for storing
6 compartimentos de 500 ml., incluye tapa para el almacenaje
6 compartiments de 500 ml chacun, avec couvercle pour le stockage

	cm	↑ cm
93171	50 x 16	10

Ersatzbehälter / replacement container / recipiente de recambio / récipient de remplacement

	cm	↑ cm	fits to
93176	14 x 7,5	7,5	93171

DRIP MATS



Bar Caddy

bar caddy
organizador de bar
organisateur „bar caddy“



Ordnungshilfe für Trinkhalme, Rührer, Servietten, Streichhölzer, etc.
to organize straws, stirrers, napkins, matches, etc.
para organizar pajitas, cucharillas, servilletas, cerillas, etc.
pour bien organiser les pailles, agitateurs, cuillers, serviettes et autres accessoires

	cm	↑ cm
93174	24 x 15	11



Glasumrander

glass rimmer
ribeteador de vasos
bordeur à verres „rimmer“



Schwamm für Limettensaft, 2 Fächer für Zucker und Salz
with sponge for lime juice, 2 cases for sugar and salt
con esponja para zumo de lima, 2 compartimentos para azucar y sal
avec éponge et 2 compartiments pour sucre et sel

	cm
93175	20 x 7,5



Barmatte

drip mat
tapete escurridor
tapis de bar



aus weichem Kunststoff, zum Abtropfen von Gläsern etc.
soft plastic, to store and drain glasses
plástico blando para escurrir vasos
plastique souple, pour l'égouttage des verres

	cm	↑ cm	Farbe / Colour	
93168	60 x 8	1	■	mit Vertiefung
93166	30 x 15	1	■	ohne Vertiefung
93173	52 x 8	1	■	ohne Vertiefung
93169	60 x 8	1	■	ohne Vertiefung
93167	45 x 31	1	■	ohne Vertiefung

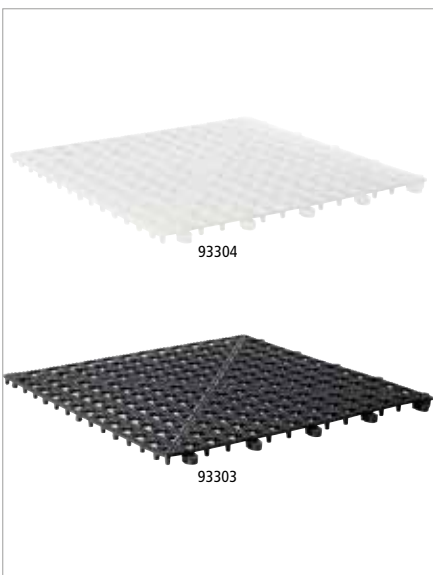

Abtropfmatte

drip mat
esterilla escurridora
tapis égouttoir



erweiterbar durch Klick-Verbindung
expandable
las placas de fijan con clips
avec clips de fixation

	cm	↑ cm	Farbe / Colour
93304	33 x 33	1,5	■
93303	33 x 33	1,5	■





STRAWS



Trinkhalme 11er Set

straws, 11 pcs. set
pajas, set de 11 pz.
pailles, set de 11 pc.



11-teiliges Set: 10 Trinkhalme aus Edelstahl + Reinigungsbürste

11 pcs. set: 10 drinking straws made of stainless steel + cleaning brush
set de 11: 10 pajas de acero inoxidable + cepillo de limpieza
set de 11: 10 pailles en acier inox + brosse de nettoyage

	Ø mm	→ cm	Farbe / Colour	
93391	8	15,0		copper-look
93392	8	15,0		gunmetal-look
93393	8	15,0		rainbow-look
93380	6	21,5		copper-look
93381	6	21,5		gunmetal-look
93382	6	21,5		rainbow-look
93383	8	21,5		copper-look
93384	8	21,5		gunmetal-look
93385	8	21,5		rainbow-look

Ersatzbürste / replacement brush / cepillo de recambio / brosse de rechange

	Ø mm	→ cm
93395	8	15
93386	8	20



Trinkhalme 7er Set

straws, 7 pcs. set
pajas, set de 7 pz.
pailles, set de 7 pc.



	Ø mm	→ cm	pcs.
93394	10	15	7
93390	10	21	7



ICE BUCKETS



Eisbox
icebox
cubitera
seau à glaçons



Innenbehälter dient als Tropfeinsatz, hält die Eiswürfel bis zu 5 Stunden in ihrer Form
inner container serves as drainer, ice bucket keeps the ice cubes in shape for up to 5 hours
contenedor interior sirve como inserto de goteo, mantiene los cubitos de hielo en forma hasta 5 horas
récipient intérieur sert d'égouttoir, maintient les glaçons dans leur forme jusqu'à 5 heures

	cm	↑ cm	ltr.	
93220	27 x 27	15	5	max. 300 ice cubes



Eisbox
icebox
cubitera
seau à glaçons



Innenbehälter dient als Tropfeinsatz, hält die Eiswürfel bis zu 5 Stunden in ihrer Form
inner container serves as drainer, ice bucket keeps the ice cubes in shape for up to 5 hours
contenedor interior sirve como inserto de goteo, mantiene los cubitos de hielo en forma hasta 5 horas
récipient intérieur sert d'égouttoir, maintient les glaçons dans leur forme jusqu'à 5 heures

	cm	↑ cm	ltr.	
93200	20 x 20	17	3,4	max. 150 ice cubes



Eisbox
icebox
cubitera
seau à glaçons



Innenbehälter dient als Tropfeinsatz, hält bis zu 5 Stunden die Eiswürfel in ihrer Form
inner container serves as drainer, keeps the ice cubes in shape for up to 5 hours
contenedor interior sirve como inserto de goteo, mantiene los cubitos de hielo en forma hasta 5 horas
récipient intérieur sert d'égouttoir, maintient les glaçons dans leur forme jusqu'à 5 heures

	Ø cm	↑ cm	ltr.	
36033	18,5	20	3	max. 150 ice cubes
36037	27	20	6	max. 300 ice cubes



Eiseimer-Set mit Eiszange
ice bucket set with tongs
cubitera clásica con pinza
seau à glaçons classique avec pince



für max. 45 Eiswürfel, hält die Eiswürfel bis zu 5 Stunden in ihrer Form
max. 45 ice cubes, keeps the ice cubes in shape for up to 5 hours
para un máximo de 45 cubitos de hielo, mantiene los cubitos de hielo en forma hasta 5 horas
pour max. 45 glaçons, maintient les glaçons dans leur forme jusqu'à 5 heures

	Ø cm	↑ cm	ltr.
36013	12	14	1



3-teiliges Set
3 pcs.



36016 1,3 ltr.

36015 1,3 ltr.

Eiseimer-Set mit Eiszange

ice bucket set with tongs
cubitera clásica con pinza
seau à glaçons classique avec pince



mit Abtropfgitter, isolierter Kunststoffeinsatz, Zange lässt sich im Deckel verstauen,
für max. 50 Eiswürfel, hält die Eiswürfel bis zu 5 Stunden in ihrer Form

with drainer, insulated plastic insert, tongs can be stored in the lid,
for max. 50 ice cubes, keeps the ice cubes in shape for up to 5 hours
con escurridor, inserto de plástico aislado, la pinza se puede guardar en la tapa, para un máxi-
mo de 50 cubitos de hielo, mantiene los cubitos de hielo en forma hasta 5 horas
avec égouttoir, insert en plastique isolé, la pince peut être rangée dans le couvercle, pour max.
50 glaçons, maintient les glaçons dans leur forme jusqu'à 5 heures

	Ø cm	↑ cm	ltr.	Farbe / Colour
36016 <small>NEW</small>	14	22	1,3	
36015	14	22	1,3	



Eiszerkleinerer

Ice crusher
picadora de hielo
broyeur à glaçons



glasklar, mit Edelstahl-Messer
clear, stainless steel cutters
cuchillas de acero inoxidable
couteaux inox

	cm	↑ cm
36017	12 x 12	24



Eisschaufel

ice scoop
pala de hielo
pelle à glaçons



	cm	→ cm	ltr.
93192	10 x 6	29	0,7



Eisschaufel

ice scoop
pala de hielo
pelle à glaçons



gelocht, ideal zum Befüllen von schlanken Gläsern
perforated, ideal to fill narrow glasses
perforada, ideal para llenar vasos estrechos
perforée, idéale pour verser les glaçons dans des verres étroits

	Ø cm	→ cm
93191	5	19,5

ICE CUBE MAKERS



Eiswürfel | ice cube
4 x 4 x 4 cm

Eiswürfelform mit Deckel, 2er Set

ice cube maker with lid, 2 pcs.
molde para cubitos de hielo con tapa, set de 2
moule à glaçons avec couvercle, set de 2

2 Eiswürfelformen für je 9 Eiswürfel

2 ice cube moulds for 9 ice cubes each

2 moldes de cubitos de hielo para 9 cubitos cada uno

2 moules à glaçons pour 9 glaçons chacun



	cm	↑ cm	ice cubes	pcs.
36102	15,5 x 15,5	5,5	4 x 4 x 4	2



Die Eiswürfel lassen sich leicht auslösen
the ice cubes are easy to release

Eiswürfel | ice cube
4 x 2,5 x 3 cm

Eiswürfelform mit Deckel, 2er Set

ice cube maker with lid, 2 pcs.
molde para cubitos de hielo con tapa, set de 2
moule à glaçons avec couvercle, set de 2

2 Eiswürfelformen für je 21 Eiswürfel

2 ice cube moulds for 21 ice cubes each

2 moldes de cubitos de hielo para 21 cubitos cada uno

2 moules à glaçons pour 21 glaçons chacun



	cm	↑ cm	ice cubes	pcs.
36103	25 x 15	4	4 x 2,5 x 3	2



Eiskugel | ice ball
Ø 6 cm

Eiskugelformer

ice ball former
molde de cubitos de hielo esféricos
moule à glaçons en boules

2-teilig, 3 Kugeln à 100 ml, einfach mit Wasser füllen und gefrieren lassen

3 bowls à 100 ml, simply fill with water and allow to freeze

3 bolas de 100 ml, simplemente llenar con agua y dejar congelar

3 boules à 100 ml, simplement remplir avec de l'eau et mettre à congeler



	cm	↑ cm	ice balls
12990	23,5 x 8,5	6,5	Ø 6



Eiszange

ice tongs
pinzas para hielo
pince de la glace

hochglanzpoliert, mit Befestigungsclip

mirror polished, with fastening clip
pulido brillante, con clip de fijación
poli brillant, avec clip de fixation



	→ cm	Farbe / Colour
75853	20	stainless steel
75854	20	copper-look
75855	20	gunmetal-look



Zange kann an einer Schale befestigt werden
tongs can be attached to a bowl

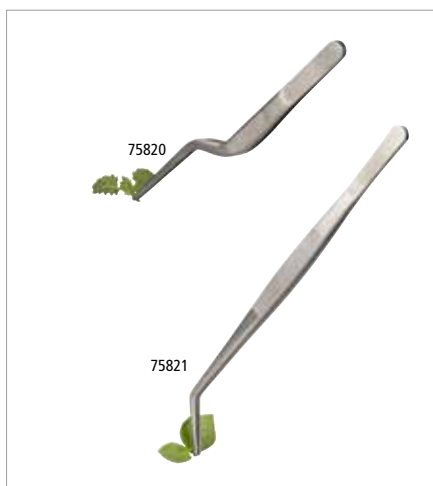

Pinzettenzange

fine tongs / tweezer
pinza de emplatar
pince à dresser

hochglanzpoliert, geriffelte Grifffläche, schwere Qualität

mirror polished, ribbed handle, heavy gauge
pulido brillante, mango cómodo ranurado, alta calidad
poli brillant, manche rainuré antiglisse, qualité extra



	→ cm
75820	16
75821	30



Eiszange

ice cube tongs
pinza para cubitos de hielo
pince à glaçons

hochglanzpoliert, fugenlos

mirror polished, seamless
pulido brillante, de una sola pieza
poli brillant, d'une seule pièce



	cm	→ cm
75805	5 x 2	17,5



Eiszange

ice tongs
pinza para cubitos de hielo
pince à glaçons

matt poliert, mit griffigem Ende, ideal für Eiswürfel und Obstscheiben

matt polished, with handy end, ideal for ice cubes and fruit slices
pulido mate, forma ergonómica ideal para cubitos de hielo y láminas de fruta
poli mat, forme ergonomique idéale pour glaçons et fruits tranchés



	cm	→ cm
93190	2 x 1,5	20



Bitterflasche / Spritzflasche

bitter bottle / spray bottle
botella / pulverizador licores
bouteille/pisette p. liqueurs

Ausgießer aus Kork, Edelstahl, ideal für Bitterliköre

cork pouring spout, stainless steel, ideal for bitter liqueurs

pico de corcho, acero inox, ideal para licores amargos

bec verseur liège, acier inox, idéal pour les liqueurs amères



	cm	↑ cm	ltr.
93359	5 x 5	13	0,1



Rührglas mit Lippe

mixing glass with lip
vaso mezclador vertedor con pico
verre mélangeur avec bec verseur

schwere Qualität

heavy quality

alta calidad

qualité renforcée



	Ø cm	↑ cm	ltr.
93141	9	16	0,5
93101	11,5	19	1,0



Dosier- & Vorratsflasche

pouring container
botella „store & pour“
bouteille „store & pour“



4-teilig: Behälter + Flaschenhals + Schraubdeckel + Ausgießer Ø 11 mm mit Luftzufuhr für gezieltes Ausgießen, zum Dosieren und Aufbewahren

4 pcs. set: for storage, mixing and serving drinks, nozzle Ø 11 mm

set de 4 piezas: para almacenar y servir mezclas y bebidas, agujero de Ø 11 mm

se compose de 4 pièces: idéal pour servir et pour conserver les boissons, embout Ø 11 mm

	Ø cm	↑ cm	ltr.	Farbe / Colour
93144	9	33	0,85	
93145	9	33	0,85	
93146	9	33	0,85	
93147	9	33	0,85	
93148	9	33	0,85	



abnehmbarer Boden dient als Deckel
removable bottom serves as a lid



Permanent-Ausgießer, 6er Set
 free flow pourer, 6 pcs.
 vertedor continuos set 6 piezas
 set de 6 bouchons verseurs continus



	↑ cm	pcs.
93110	11	6



Permanent-Ausgießer, 6er Set
 free flow pourer, 6 pcs.
 vertedor continuos set 6 piezas
 set de 6 bouchons verseurs continus



	↑ cm	pcs.
93114	8	6



Sekt-Verschluss, 2er Set
 stopper, 2 pcs.
 set de 2 taponos
 set de 2 bouchons
matt poliert, innen Gummi Arabicum
 matt polished, inside rubber arabicum, with inscription
 pulido mate, interior goma arábica con inscripción
 poli maté, intérieur gomme arabique



	Ø cm	↑ cm	pcs.
93160	4	5,5	2



Permanent-Ausgießer, 6er Set
 free flow pourer, 6 pcs.
 vertedor continuos set 6 piezas
 set de 6 bouchons verseurs continus
à 2 Stück: blau, rot, gelb
 2 pcs of each colour: blue, red, yellow
 2 piezas de cada color: azul, rojo, amarillo
 2 par couleur: bleu, rouge, jaune



	Ø cm	↑ cm	pcs.
93111	3	7,5	6



Reinigungsbürste für Ausgießer
 pourer cleaning brush
 cepillo de limpieza para picos vertedores
 brosse lave-bouchons doseurs



	→ cm
93102	16,5



Staubkappen, 2er Set
 dust & fly cap, 2 pcs.
 tapón antipolvo
 bouchon anti-poussières et anti-insectes
schützt vor Staub und Insekten
 protects for dust and insects
 para proteger de la suciedad e insectos
 pour protéger de la poussière et des insectes



	Ø cm	↑ cm	Farbe / Colour	pcs.
93161	4	8	■	2



Kellnermesser „PROFI“

waiter's corkscrew
sacacorchos de camarero
tire-bouchons



leichtgängige Teflon-Spirale, mehrstufige Klapphebelfunktion, am Fuß angebrachtes Messer
easy moving teflon coil, 2-stage opening system, knife at the bottom end
mecha de teflón, sistema de apertura en 2 golpes, con cuchillo en la parte superior
mèche téflon, ouverture en 2 étapes, couteau dans la partie supérieure

→ cm

93302 11,5



Kellnermesser

waiter's corkscrew
sacacorchos de camarero
tire-bouchons



leichtgängige Teflon-Spirale, mehrstufige Klapphebelfunktion, am Kopf angebrachtes Messer
easy moving teflon coil, 2-stage opening system, knife at the top end
mecha de teflón, sistema de apertura en 2 golpes, con cuchilla en la parte superior
mèche téflon, ouverture en 2 étapes, couteau dans la partie supérieure

→ cm

93301 12



Kellner-Flaschenöffner

waiter's barblade
abridor camarero
décapsuleur



magnetisch, schwarz / magnetic, black / magnético, negro / magnétique, noir

→ cm

Farbe / Colour

93377 18



Kellner-Flaschenöffner

waiter's barblade
abridor camarero
décapsuleur



magnetisch, matt poliert / magnetic, matt polished / magnético, pulido mate / magnétique, poli mat

→ cm

Farbe / Colour

93122 18



matt poliert / matt polished / pulido mate / poli mat

→ cm

Farbe / Colour

00617 13,5



Kellner-Flaschenöffner

waiter's barblade
abridor camarero
décapsuleur



magnetisch, mit Gummierung

magnetic, with rubber coating

magnético, con revestimiento de goma

magnétique, avec revêtement en caoutchouc

→ cm

93125 11



Kronkorkenöffner

bottle cap opener
abridor de chapas de pared
décapsuleur mural



für die Wandmontage, aus massivem Metall, inklusive 2 Schrauben
for wall fastening, massive metal, including 2 screws
para fijación en la pared, metal macizo, incluye 2 tornillos
massif, à fixer au mur, y compris 2 vis

	cm	↑ cm
93124	7 x 8	3

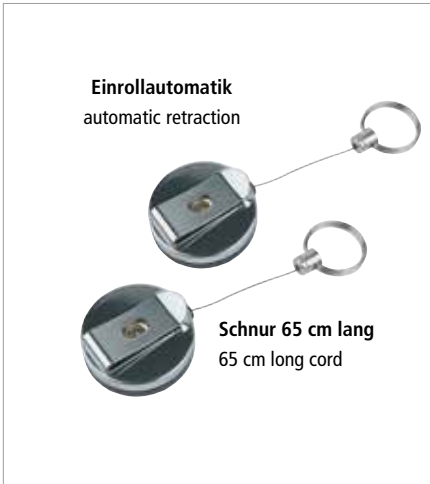

Schlüsselschnur, 2er Set

key cord, 2 pcs.
llavero enrollable
porte-clés avec câble à enroulement



Befestigung mit Klammer am Gürtel, starke Rückzugfeder
to fix at waistbelt, strong pull-back spring
se fija en el cinturón, cable retrocede automáticamente
à fixer à la ceinture, enroulage automatique

	Ø cm	↑ cm
93170	4	2



Flaschenkühler „CONFERENCE“

conference bottle cooler
enfriador múltiple
rafraîchisseur



inkl. Kühllakku, Flaschenöffner, Kronkorkenschale,
mit 6 Öffnungen Ø 6,7 cm für 0,25 - 0,5 Liter-Flaschen
incl. bottle cooler, bottle opener, small cap bowl,
with 6 holes Ø 6,7 cm for 0,25 to 0,5 liter bottle
con acumulador de frío, abridor, recuperador de chapas,
6 plazas Ø 6,7 cm, para botellas de 25 a 50 cl
avec accumulateur de froid, décapsuleur, bol récupérateur
de capsules, 6 places Ø 6,7 cm, pour bouteilles de 25 à 50 cl

	Ø cm	↑ cm	Farbe / Colour
00620	23	15	White
00621	23	15	Black

Kühllakku / cooler / acumulador de frío / accumulateur de froid

	Ø cm	↑ cm	Farbe / Colour
00615	7,5	11,5	Black

Kronkorkenschale / cap bowl / cuenco para chapas / bol récupérateur de capsules

	Ø cm	↑ cm	Farbe / Colour
00618	6,5	3	White
00619	6,5	3	Black

Flaschenöffner / bottle opener / abridor / décapsuleur

	Ø cm	→ cm
00617	1	13,5



LIME AND LEMON SQUEEZERS



Limetten- / Zitronenpresse
lime- / lemon squeezer
exprimidor de limón / lima
presse citron



2 Pressringe für Zitrone und Limette
2 squeezing rings for lemon and lime
2 anillos exprimidores para limón y lima
2 anneaux à presser pour le citron et le lime

	cm	↑ cm
93214	21 x 7	5



Limettenpresse
lime squeezer
prensa de limón
presse citron



	cm	↑ cm
93189	21 x 7	5



Zitruspresse
citrus squeezer
exprimidor cítricos
presse-citron



hochglanzpoliert, 2-teilig / mirror polished, 2 pcs. / pulido brillante, 2 piezas / poli brillant, 2 pièces

	Ø cm	↑ cm	ltr.
71431	12 / 17	10,5	0,35

NEW **SAMOWAR**

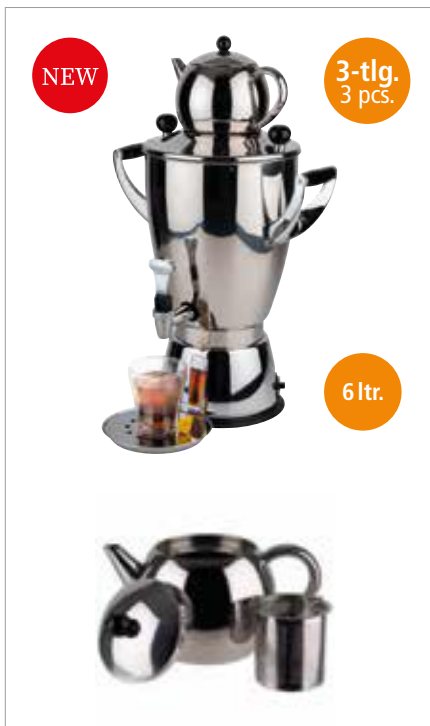
**Samovar**

samovar
samovar
samovar

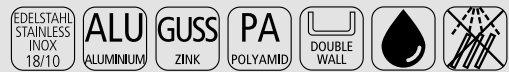
**3-teiliges Set:**

- 1 Samovar, 230V, 50/60Hz, 1.800W (6 Liter)
- 1 Teekanne (1,1 Liter)
- 1 Tropfenschale

3 pcs. set:

- 1 samovar, 230V, 50/60Hz, 1.800W (6 ltr.)
- 1 teapot (1,1 ltr.)
- 1 drip tray

set de 3:

- 1 samovar, 230V, 50/60Hz, 1.800W (6 L.)
- 1 tetera (1,1 L.)
- 1 bandeja recoge gotas

set de 3:

- 1 samovar, 230V, 50/60Hz, 1.800W (6 L.)
- 1 théière (1,1 L.)
- 1 bac ramasse-gouttes

	cm	↑ cm	ltr.
12315	35 x 21	58	6

**Samovar**

samovar
samovar
samovar

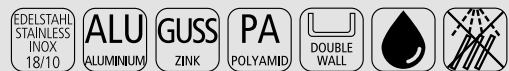
**3-teiliges Set:**

- 1 Samovar, 230V, 50/60Hz, 1.800W (12 Liter)
- 1 Teekanne (1,3 Liter)
- 1 Tropfenschale

3 pcs. set:

- 1 samovar, 230V, 50/60Hz, 1.800W (12 ltr.)
- 1 teapot (1,3 ltr.)
- 1 drip tray

set de 3:

- 1 samovar, 230V, 50/60Hz, 1.800W (12 L.)
- 1 tetera (1,3 L.)
- 1 bandeja recoge gotas

set de 3:

- 1 samovar, 230V, 50/60Hz, 1.800W (12 L.)
- 1 théière (1,3 L.)
- 1 bac ramasse-gouttes

	cm	↑ cm	ltr.
12316	42 x 26	75	12

TEAPOTS



Teekanne „ASIA“

teapot
tetera
théière



aus Gusseisen, innen emailliert, abnehmbarer Deckel, mit Teesieb aus Edelstahl

made of cast iron, enamelled inside, removable lid, with tea strainer made of stainless steel
hierro fundido, interior esmaltado, tapa extraíble, con colador de té de acero inoxidable
en fonte, émaillé à l'intérieur, couvercle amovible, avec une passoire à thé en acier inox

	cm	↑ cm	ltr.	Farbe / Colour
10995	17 x 14	17	0,8	■
10996	17 x 14	17	0,8	■



Teekanne „ASIA“

teapot
tetera
théière



aus Gusseisen, innen emailliert, abnehmbarer Deckel, mit Teesieb aus Edelstahl

made of cast iron, enamelled inside, removable lid, with tea strainer made of stainless steel
hierro fundido, interior esmaltado, tapa extraíble, con colador de té de acero inoxidable
en fonte, émaillé à l'intérieur, couvercle amovible, avec une passoire à thé en acier inox

	cm	↑ cm	ltr.	Farbe / Colour
10991	19,5 x 18	15	0,8	■
10992	19,5 x 18	15	0,8	■



Teekanne „ASIA“

teapot
tetera
théière



aus Gusseisen, innen emailliert, mit abnehmbarem Deckel, ohne Teesieb aus Edelstahl
made of cast iron, enamelled inside, with removable lid, without tea strainer made of stainless steel

hierro fundido, interior esmaltado, con tapa extraíble, sin colador de té de acero inoxidable
en fonte, émaillé à l'intérieur, avec couvercle amovible, sans une passoire à thé en acier inox

	cm	↑ cm	ltr.	Farbe / Colour
10990	12,5 x 11	12,5	0,3	■



10994



10993

Stövchen „ASIA“

teapot warmer
calentador de tetera
chauffe-théière



1-flammiges Stövchen aus Gusseisen mit abnehmbarem Deckel (Lieferung ohne Teelicht).

1-flame cast iron warmer with removable lid (delivery without tealight).

calentador de tetera de hierro fundido con 1 quemador con tapa extraíble (se entrega sin vela).

chauffe-théière en fonte à 1 brûleur avec couvercle amovible (livraison sans bougie).

	∅ cm	↑ cm	Farbe / Colour
10994	13	7,5	■

Untersetzer aus Gusseisen mit Antirutschfüßchen / cast iron coaster with non-slip feet

	∅ cm	↑ cm	Farbe / Colour
10993	13,5	1,5	■



11575

Teebox

tea-box
caja para té
boîte à thés et infusions



Box aus Rubberwood mit Sichtfenster, mit Aufschrift „Tee“, 4 Kammern können mit je 30 kuvertierten Teebeuteln bestückt werden

rubber wood box with clear transparent window, with inscription „Tee“, 4 chambers for approx. 30 tea bags each

caja de madera de goma clara con ventana transparente, con inscripción „Tee“, 4 compartimentos, y cada uno para aproximadamente 30 bolsitas de té

en bois d'hévéa clair avec fenêtre, avec inscription „Tee“, 4 compartiments, pour environ 30 sachets chacun

	cm	↑ cm	Farbe / Colour
11575	33,5 x 20	9	■
11574	33,5 x 20	9	■

	cm	↑ cm	Farbe / Colour	
11576	33,5 x 20	9	■	ohne Aufschrift / without inscription sin inscripción / sans inscription



11776

Teebox

tea-box
caja para té
boîte à thés et infusions



Box aus Rubberwood mit Sichtfenster, mit Aufschrift „Tee“, 12 Kammern können mit je 12 kuvertierten Teebeuteln bestückt werden

rubber wood box with clear transparent window, with inscription „Tee“, 12 chambers for approx. 12 tea bags each

caja de madera de goma clara con ventana transparente, con inscripción „Tee“, 12 compartimentos, y cada uno para aproximadamente 12 bolsitas de té

en bois d'hévéa clair avec fenêtre, avec inscription „Tee“, 12 compartiments, pour environ 12 sachets chacun

	cm	↑ cm	Farbe / Colour
11775	31 x 28	9	■
11776	31 x 28	9	■

**Teebox / Multibox**

tea caddy
caja para té
boîte à thés et infusions



3 Fächer für kuvertierte Teebeutel, 1 Fach für Zucker, Kekse, etc., Deckel aufklappbar

3 compartments for tea bags, 1 compartment for sugar, biscuits, etc., hinged lid

3 compartimentos para bolsitas de té, 1 compartimento para azúcar, galletas, etc. tapa abatible

3 compartiments pour sachets de thé, 1 compartiment pour sucre, biscuits, etc., couvercle abatible

	cm	↑ cm
11563	22 x 17	9

BARISTA

Life begins after coffee



Milch-/Universalkanne

non stick jug
jarra antiadherente
pichet antiadhésif

Antihafbeschichtet, perfekt für die Herstellung von Milchschaum
coated, for baristas frothing hot milk
revestimiento, ideal para espume de leche
revêtement, idéal pour faire mousser le lait



	Ø cm	↑ cm	ltr.
10334	8,0	10,0	0,35
10335	9,0	11,5	0,60
10336	10,5	13,0	0,80



Milch- / Universalkanne

milk / water jug
jarra leche / agua
pichet à eau / lait

außen hochglanzpoliert, innen matt poliert, mit Maßskalierung innen
outside mirror polished, inside matt polished, with dimension scaling inside
exterior pulido brillante, interior pulido mate, con escala de dimensiones en el interior
extérieur poli brillant, intérieur poli mat, avec une échelle de dimension à l'intérieur



	Ø cm	↑ cm	ltr.
10328	8,0	10,0	0,35
10329	9,0	11,5	0,6
10330	10,5	13,0	0,8
10331	12,0	16,5	1,3
10332	13,5	18,0	2,0



Milch- / Universalkanne „VEGAN“

milk / water jug
jarra leche / agua
pichet à eau / lait

außen hochglanzpoliert, innen matt poliert, mit Gravur „VEGAN“
outside mirror polished, inside matt polished, with engraving „VEGAN“
exterior pulido brillante, interior pulido mate, con grabado „VEGAN“
extérieur poli brillant, intérieur poli mat, avec gravure „VEGAN“



	Ø cm	↑ cm	ltr.
10350	9,0	11,5	0,6
10351	10,5	13,0	0,8



10361

Milch- / Universalkanne

milk / water jug
jarra leche / agua
pichet à eau / lait



außen weiß pulverbeschichtet, innen matt poliert

outside white powder coated, inside matt polished
exterior recubrimiento de polvo blanco, interior pulido mate
extérieur revêtement en poudre blanc, intérieure poli mat

	Ø cm	↑ cm	ltr.
10360	8,0	10,0	0,35
10361	9,0	10,0	0,50
10362	9,5	11,5	0,75

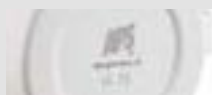

mit Gravur am Boden
with engraving on the bottom



10323

Kaffeekanne

coffee pot
cafetera
pichet à café



hochglanzpoliert, mit Klappdeckel

mirror polished, with hinged cover
pulido brillante, tapa con bisagra
poli brillant, couvercle à charnière

	Ø cm	↑ cm	ltr.
10323	8,0	11,5	0,35
10322	9,0	14,0	0,6
10325	10,5	15,5	0,9
10326	12,0	18,5	1,5
10327	13,5	20,0	2,0



verstellbar durch Verschieben des Clips
adjustable by sliding the clip

Thermometer für Milchkännchen

thermometer for milk / water jug
termómetro para jarra leche / agua
thermomètre pour pichet à eau / lait



mit Clip, höhenverstellbar, Temperaturbereich 20°C bis 100°C, Graduierung 2°C

with clip, height adjustable, temperature range 20°C to 100°C, graduation 2°C
con clip, regulable en altura, rango de temperatura de 20°C a 100°C, graduación 2°C
avec clip, réglable en hauteur, plage de température 20°C à 100°C, graduation 2°C

	Ø cm	↑ cm
10355	4,0	13,5



Anwendungsbeispiel
application example



Mini-Milchkanne „SNACKHOLDER“ 4er Set

mini milk can, 4 pcs.
lechera en formato mini, set de 4
pot à lait mini, set de 4



	Ø cm	↑ cm	ltr.	pcs.
40640	4,5	5	0,08	4



Milchkännchen / Sahnegießer, 4er Set

milk/cream jugs, 4 pcs.
pack de 4 jarritas para leche o crema
pack de 4 crémiers

hochglanzpoliert, für Kaffeesahne, mit Griff, Inhalt à 25 ml
mirror polished, for coffee-cream, with handle, capacity à 25 ml
pulido brillante, para crema de café, con asa, capacidad 25 ml
poli brillant, avec anse, 25 ml



	Ø cm	↑ cm	ltr.	pcs.
10321	3,5	3,5	0,025	4



Milchkännchen / Sahnegießer

milk / cream jug
jarra de leche/ crema
pichet à eau ou lait



	Ø cm	↑ cm	ltr.
10318	4	4	0,05
10319	5	5	0,09
10320	6	6	0,15



Allzweckgießer

pourer
bote vertedor universal
pot verseur universel
für Honig, Kaffeesahne, etc., Schraubdeckel
for honey, cream, etc., screw cap
para miel, crema, etc., tapa de rosca
pour le miel, le lait, la crème, etc., bouchon à vis



	Ø cm	↑ cm	ltr.
00765	8,5	13,5	0,3

Ersatzglasbehälter / spare glas-container / contenedor de repuesto / récipient verre de rechange

00768



Allzweckgießer

pourer
dosificador
doseur
für Honig, Kaffeesahne, etc., Schraubdeckel
for honey, cream, etc., screw cap
para miel, crema, etc., tapa de rosca
pour le miel, le lait, la crème, etc., bouchon à vis



	Ø cm	↑ cm	ltr.
40488	8	12,5	0,25



Zuckerdosierer

sugar dispenser
azucarero
sucrier



Schraubdeckel, mit Dosierrohr / screw cap, with dosing tube / tapa de rosca y tubo dosificador / bouchon à vis et tube doseur

	Ø cm	↑ cm	ltr.
40509	6	14,5	0,2
40508	6,5	14,5	0,2



Zuckerdosierer

sugar dispenser
azucarero
sucrier



Schraubdeckel, mit Dosierrohr / screw cap, with dosing tube / tapa de rosca y tubo dosificador / bouchon à vis et tube doseur

	Ø cm	↑ cm	ltr.
00766	8,5	15	0,3

Ersatzglasbehälter / spare glas-container / contenedor de repuesto / récipient verre de rechange

00768



Zuckerdosierer

sugar dispenser
azucarero
sucrier



Schraubdeckel, mit Dosierrohr / screw cap, with dosing tube / tapa de rosca y tubo dosificador / bouchon à vis et tube doseur

	Ø cm	↑ cm	ltr.
40506	7,5	17,0	0,32



Zuckerdosierer

sugar dispenser
azucarero
sucrier



Schraubdeckel, mit Dosierrohr / screw cap, with dosing tube / tapa de rosca y tubo dosificador / bouchon à vis et tube doseur

	Ø cm	↑ cm	ltr.
40486	8	15	0,25



Zuckerdosierer

sugar dispenser
azucarero
sucrier



Schraubdeckel, mit Dosierrohr / screw cap, with dosing tube / tapa de rosca y tubo dosificador / bouchon à vis et tube doseur

	Ø cm	↑ cm	ltr.
40490	8,5	12	0,15
40494	8,0	15	0,25

Ersatzglasbehälter / spare glas-container / contenedor de repuesto / récipient verre de rechange

fits to	
40498	40490
40499	40494



Zuckerdosierer

sugar dispenser
azucarero
sucrier



Schraubdeckel mit Klappe, mit Dosierklappe / screw cap, with dosing flap / tapa de rosca, con tubo dosificador / bouchon à vis, avec couvercle doseuse

	Ø cm	↑ cm	ltr.
40487	7,5	13,5	0,32

Zuckerdosierer „OLD FASHIONED“ / sugar dispenser / azucarero / sucrier

	Ø cm	↑ cm	ltr.
40510	7,5	14	0,35



Zuckerkugel

sugar pot
azucarero
sucrier



hochglanzpoliert, mit Rolldeckel

mirror polished, rolltop cover
pulido brillante, tapa abatible
poli brillant, couvercle abattant

	Ø cm	↑ cm
00033	13,5	15



Milch- und Zucker-Set

milk and sugar set
set de crema y azúcar
set lait et sucre



5-teilig: Tablett, Milchkanne, Zuckerdose mit Deckel, Löffel, Akazienholz, Edelstahl beschichtet, schwarz

5 pcs.: tray, milk jug, sugar bowl with lid, spoon, acacia wood, stainless inox coated, black
set de 5: bandeja, jarra de leche, azucarero con tapa, cuchara, madera de acacia, acero inoxidable revestimiento, negro

set de 5: plateau, pichet à lait, sucrier avec couvercle, cuillère, bois d'acacia, acier inox revêtement, noir

	cm	↑ cm
00634	19 x 10	10,5



Teebrühsieb

snap mesh tea ball
infusor de té, pinza con malla
boule à thé avec pince



matt poliert, mit feinem Sieb, aufklappbar / matt polished, with fine mesh, hinged / pulido mate, con malla fina, con bisagra / poli mat, maille fine, avec charnière

	Ø cm	→ cm
74750	4,5	15,5



Zitronenschnitzpresse

lemon slice squeezer
pinza exprimelimon
pince presse citron

hochglanzpoliert, zum Auspressen von Zitronenscheiben / mirror polished, to press lemon slices / pulido brillante, para rodajas de limón / poli brillant, pour citrons en rondelle



cm	
71430	8 x 7



NEW

GN 1/6 Abklopfbehälter

GN 1/6 tapping container
GN 1/6 contenedor knock-out
GN 1/6 bac knock-out

mit Abklopfstange aus Silikon, rutschfester Boden

with silicone tapping rod, non-slip bottom
con varilla de silicona, base antideslizante
avec tige en silicone, fond antidérapant



	cm	↑ cm	ltr.
81611	17,6 x 16,2	15	2,4



rutschfester Boden
non-slip bottom



250 ml

Becher Set „SUPER CUP“, 8er Set

barrel mug set, 8 pcs.

vasos, set de 8
gobelets, set de 8

Set bestehend aus 8 Bechern + 8 Deckeln

set consists of 8 barrel mugs + 8 lids

set compuesto por 8 vasos + 8 tapas

set composé de 8 gobelets + 8 couvercles



IDEAL
FÜR
„TAKE AWAY“

	Ø cm	↑ cm	ltr.	pcs.
10506	8	10	0,25	8



mit Stapelnocke
with stacking cam



rutschfester Deckel
non-slip lid



Servierbeispiel Deckel
presentation example cover



NEW SNUG



Espressotasse „SNUG“

espresso cup
taza de espresso
tasse à espresso



Porzellan, Griff: 2 cm / porcelain, handle: 2 cm / porcelana, asa: 2 cm / porcelaine, poignée: 2 cm

	Ø cm	↑ cm	ltr.	Farbe / Colour	VE / unit
16000	6	5,5	0,08		6
16001	6	5,5	0,08		6
16002	6	5,5	0,08		6



Espressountertasse „SNUG“

espresso saucer
platillo de espresso
soucoupe à espresso



Porzellan / porcelain / porcelana / porcelaine

	Ø cm	↑ cm	Farbe / Colour	VE / unit
16009	11,5	2		6
16010	11,5	2		6
16011	11,5	2		6





Kaffeetasse „SNUG“

coffee cup
taza de café
tasse à café



Porzellan, Griff: 2 cm / porcelain, handle: 2 cm / porcelana, asa: 2 cm / porcelaine, poignée: 2 cm

	Ø cm	↑ cm	ltr.	Farbe / Colour	VE / unit
16003	9,5	6	0,2		6
16004	9,5	6	0,2		6
16005	9,5	6	0,2		6



Kaffeuntertasse „SNUG“

coffee saucer
platillo de café
soucoupe à café



Porzellan / porcelain / porcelana / porcelaine

	Ø cm	↑ cm		Farbe / Colour	VE / unit
16012	14,5	2,5			6
16013	14,5	2,5			6
16014	14,5	2,5			6



Cappuccinotasse „SNUG“

cappuccino cup
taza de cappuccino
tasse à cappuccino



Porzellan, Griff: 3 cm / porcelain, handle: 3 cm / porcelana, asa: 3 cm / porcelaine, poignée: 3 cm

	Ø cm	↑ cm	ltr.	Farbe / Colour	VE / unit
16006	10,5	6,5	0,3		6
16007	10,5	6,5	0,3		6
16008	10,5	6,5	0,3		6



Cappuccinountertasse „SNUG“

cappuccino saucer
platillo de cappuccino
soucoupe cappuccino



Porzellan / porcelain / porcelana / porcelaine

	Ø cm	↑ cm		Farbe / Colour	VE / unit
16015	15,5	2,5			6
16016	15,5	2,5			6
16017	15,5	2,5			6



TWINZ



„espresso size“

Gläser, 2er Set „TWINZ“

glasses, 2 pcs. set
vasos, set de 2
verres, set de 2

doppelwandig, ideal für Espresso
glass, double-walled, ideal for espresso
vidrio, doble pared, ideal para espresso
verre, à double paroi, idéal pour l'espresso



	Ø cm	↑ cm	ltr.	pcs.
10370	6	6,5	0,08	2



„coffee and tea size“

Gläser, 2er Set „TWINZ“

glasses, 2 pcs. set
vasos, set de 2
verres, set de 2

doppelwandig, ideal für Kaffee oder Tee
glass, double-walled, ideal für coffee or tea
vidrio, doble pared, ideal para café o té
verre, à double paroi, idéal pour le café ou le thé



	Ø cm	↑ cm	ltr.	pcs.
10371	8,5	8,5	0,23	2



„latte macchiato size“

Gläser, 2er Set „TWINZ“

glasses, 2 pcs. set
vasos, set de 2
verres, set de 2

doppelwandig, ideal für Latte Macchiato
glass, double-walled, ideal for Latte Macchiato
vidrio, doble pared, ideal para latte macchiato
verre, à double paroi, idéal pour le latte macchiato



	Ø cm	↑ cm	ltr.	pcs.
10372	8,5	14	0,38	2

Der nachhaltige Mehrwegbecher – made in Germany



Das Ribbendesign isoliert die Hitze – kein „Verbrennen“ der Finger möglich

The rib design insulates the heat - no „burning“ of the fingers possible

Mehrwegbecher individuell mit Ihrem Logo/Namen herstellbar ab 500 Stck. – sprechen Sie uns an!

Reusable cups can be individually produced with your logo/name. From 500 pieces - please contact us!

- ✓ aufsteckbarer Deckel mit Trinköffnung
- ✓ 100% recyclebar
- ✓ spülmaschinengeeignet
- ✓ stapelbar mit und ohne Deckel
- ✓ schwappsicher

clip-on lid with drinking opening

100% recyclable

dishwasher safe

stackable with and without lid

slosh-/leak-proof



To Go Mehrwegbecher

To Go reusable cup
vaso reutilizable To Go
tasse réutilisable To Go

Becher (ohne Deckel)

cup (without cover)

vaso (sin tapa)

tasse (sans couvercle)



	Ø cm	↑ cm	ltr.	Farbe / Colour	VE / unit
66910	8,5	13,5	0,4		48
66911	8,5	13,5	0,4		48
66912	8,5	13,5	0,4		48
66913	8,5	13,5	0,4		48

Deckel / cover / tapa / couvercle

	Ø cm	↑ cm	Farbe / Colour	VE / unit
66914	8,5	2,5		48
66915	8,5	2,5		48
66916	8,5	2,5		48
66917	8,5	2,5		48

DRINKING BOTTLES



Trinkflasche
drinking bottle
cantimplora
gourde

EDELSTAHL
STAINLESS
INOX
18/8

HOLZ
WOOD

die doppelwandige Vakuumflasche aus Edelstahl hält Heißes 12 Stunden heiß und Kaltes 24 Stunden kalt, 100% auslaufsicher

the double-walled stainless steel vaccum bottle keeps hot drinks hot for 12 hours and cold drinks cold for 24 hours, 100% leak proof

la cantimplora al vacío de acero inoxidable de doble pared mantiene las bebidas calientes durante 12 horas y las frías durante 24 horas, 100% transporte sin salpicaduras

la gourde à vide en acier inoxydable à double paroi permet de conserver les boissons chaudes pendant 12 heures et les boissons froides pendant 24 heures, 100% transport sans éclaboussures

	Ø cm	↑ cm	ltr.
66905	7,5	24,5	0,5



Trinkflasche
drinking bottle
cantimplora
gourde

EDELSTAHL
STAINLESS
INOX
18/8

HOLZ
WOOD

die doppelwandige Vakuumflasche aus Edelstahl hält Heißes 12 Stunden heiß und Kaltes 24 Stunden kalt, 100% auslaufsicher

the double-walled stainless steel vaccum bottle keeps hot drinks hot for 12 hours and cold drinks cold for 24 hours, 100% leak proof

la cantimplora al vacío de acero inoxidable de doble pared mantiene las bebidas calientes durante 12 horas y las frías durante 24 horas, 100% transporte sin salpicaduras

la gourde à vide en acier inoxydable à double paroi permet de conserver les boissons chaudes pendant 12 heures et les boissons froides pendant 24 heures, 100% transport sans éclaboussures

	Ø cm	↑ cm	ltr.
66906	7,5	29,5	0,75



...immer dabei



mit Schraubverschluss
with screw cap

inkl. Ersatzdichtung
incl. spare gasket

500 ml

750 ml

NEW

DRINKING BOTTLES



NEW



66907 0,55 ltr



66908 0,75 ltr



66909 1 ltr

Trinkflasche
drinking bottle
botella para beber
gourde

Glas mit Schraubverschluss aus 18/8 Edelstahl
screw cap made of 18/8 stainless steel
tapón de rosca de 18/8 acero inoxidable
bouchon à vis en 18/8 acier inox



	Ø cm	↑ cm	ltr.
66907	6,5	23,5	0,55
66908	7	26,5	0,75
66909	7,5	28,5	1



66907

66908

66909



mit Schraubverschluss
with screw cap



66907

0,55 ltr

66908

0,75 ltr

66909

1 ltr



Tablett

tray
bandeja
plateaux



Melamin, schwarz, mit Antirutsch-Füßchen, passendes Schneidebrett Nr. 762, 763

melamine, black, with non-slip feet, suitable cutting board art. 762, 763

melamina, negro, con pies antideslizantes, tabla de cortar adecuada art. 762, 763

mélamine, noir, avec pieds antidérapants, planche à découper appropriées art. 762, 763

	cm	↑ cm
85225	67 x 38	4



Tablett „VINTAGE“

tray
bandeja
plateau



Antik-Edelstahl-Look

stainless steel antique look

acero estilo antiguo

acier style antique

	cm	↑ cm	
30130	26,0 x 13,5	1,5	rectangular
30131	34,0 x 18,0	1,5	rectangular
30132	38,0 x 26,5	1,5	rectangular
30133	25,5 x 16,0	3,0	rectangular
30140	20,0 x 14,5	1,0	oval
30141	26,5 x 19,5	1,0	oval
30142	29,0 x 22,0	1,0	oval

passende Schälchen / fitting bowls / cuencos adecuados / bols appropriés



	Ø cm	↑ cm	ltr.
40655	7,5	5,5	0,17
40656	7,5	10	0,35



Wachspapier „SNACKHOLDER“ / greaseproof paper squares
papel alimenticio para cucurucho / papier alimentaire pour cornet



	cm	pcs.	Motiv: Zeitung
40670	42 x 25	500	



Servierbeispiel
presentation example

**Serviertablett „KAFFEEHAUS“**

tray
bandeja
plateau

matt poliert, Rand eingerollt

matt polished, rolled edge

acabado pulido efecto pulido mate, borde redondeado

effet poli mat, bord rond



	cm	↑ cm
30119	23 x 23	1,5
30118	21,5 x 13	1,5

**Serviertablett „KAFFEEHAUS“**

tray
bandeja
plateau

matt poliert, oval, Rand eingerollt

matt polished, oval, rolled edge

pulido mate, oval, borde redondeado

poli mat, ovale, bord rond

für Zucker und Sahne / for sugar and cream / para azúcar y crema / pour le sucre et la crème

	cm	↑ cm
30111	20,0 x 14,5	0,5

für eine Tasse / for one cup / para una taza / pour une tasse

	cm	↑ cm
30112	26,5 x 19,5	0,5

für zwei Tassen / for two cups / para dos tazas / pour deux tasses

	cm	↑ cm
30113	29,0 x 22,0	0,5

**Serviertablett „KAFFEEHAUS“**

tray
bandeja
plateau

hochglanzpoliert, oval, Rand eingerollt

mirror polished, oval, rolled edge

pulido brillante, ovalado, borde redondeado

poli brillant, ovale, bord rond

für Zucker und Sahne / for sugar and cream / para azúcar y crema / pour le sucre et la crème

	cm	↑ cm
30115	20,0 x 14,5	0,5

für eine Tasse / for one cup / para una taza / pour une tasse

	cm	↑ cm
30116	26,5 x 19,5	0,5

für zwei Tassen / for two cups / para dos tazas / pour deux tasses

	cm	↑ cm
30117	29,0 x 22,0	0,5



TRAYS



30148



30149

Serviertablett „KAFFEEHAUS“

tray
bandeja
plateau

hochglanzpoliert, stabiler Rand eingerollt
mirror polished, stable edge rolled in
pulido brillante, borde estable enrollado
poli brillant, bord stable enroulé



	cm	↑ cm
30148	Ø 27	1,5
30149	30 x 15,5	1,5

passende Hauben / cover / campana / cloche



	cm	↑ cm	suitable for
11055	Ø 23	12,0	30148
11056	26 x 12	10,0	30149



Servierbeispiel
presentation example



Serviertablett „KAFFEEHAUS“

tray
bandeja
plateau

Innenfläche ziseliert, Rand eingerollt
chiselled inner surface, rolled edge
superficie interior cincelada, borde redondeado
surface intérieure ciselée bord rond



	cm	VE / unit
30114	30 x 22	48



84251

Serviertablett „KAFFEEHAUS“

tray
bandeja
plateau



	cm	↑ cm	Farbe / Colour
84251	26,0 x 20,0	1,5	■
84253	28,5 x 21,5	1,5	■



Tablett „BISTRO“

tray
bandeja
plateau

rutschfest, mit 2 Griffmulden und Stapelrand

non-slip, two open handles, stackable edge

anti-deslizante, 2 asas

antidérapant, 2 anses



	Ø cm	↑ cm	Farbe / Colour
84045	35,5	4,5	■



00510

Serviertablett „HAPPY HOUR“

tray
bandeja
plateau

rutschfeste Oberfläche / non-slip surface / superficie anti-deslizante / surface antidérapante



	Ø cm	↑ cm	Farbe / Colour
00510	32	1,5	■
00511	38	1,5	■
00515	43	1,5	■



00500

Bierglasträger „NON-SLIP“

beer rack
bandeja para cerveza
porte verre à bière

rutschfeste Oberfläche / non-slip surface / superficie anti-deslizante / surface antidérapante



	Ø cm	↑ cm	Farbe / Colour
00500	36	3,5	■

	cm	↑ cm	Farbe / Colour
00506	28 x 20	1,5	■



00548

Tablett „GASTRO“

tray
bandeja
plateau

rutschfeste Oberfläche / non-slip surface / superficie anti-deslizante / surface antidérapante



	Ø cm	↑ cm	Farbe / Colour
00547	27,5	2	■
00548	35,5	2	■
00549	40,5	2	■



00502

Serviertablett „NON-SLIP“

tray non-slip
bandeja antideslizante
plateau antiglisse

rutschfeste Oberfläche

non-slip surface

superficie antideslizante

surface antidérapante



	cm	↑ cm	GN	Farbe / Colour
00502	53 x 32,5	1,5	1/1	■
00508	46 x 36,0	2		■



FAST FOOD TRAYS



Fast Food-Tablett
 snack tray
 bandeja autoservicio y snacks
 plateau self-service et snacks



	cm	↑ cm	GN	Farbe / Colour
00530	35 x 27,0	2		
00535	41 x 30,5	2		
00540	45 x 35,5	2		
00552	53 x 32,5	2	1/1	

	cm	↑ cm	GN	Farbe / Colour
00531	35 x 27,0	2		
00536	41 x 30,5	2		
00541	45 x 35,5	2		
00553	53 x 32,5	2	1/1	

	cm	↑ cm	GN	Farbe / Colour
00532	35 x 27,0	2		
00537	41 x 30,5	2		
00542	45 x 35,5	2		
00554	53 x 32,5	2	1/1	

	cm	↑ cm	GN	Farbe / Colour
00533	35 x 27,0	2		
00538	41 x 30,5	2		
00543	45 x 35,5	2		
00555	53 x 32,5	2	1/1	

	cm	↑ cm	GN	Farbe / Colour
00534	35 x 27,0	2		

	cm	↑ cm	GN	Farbe / Colour
00539	35 x 27,0	2		



stapelbar
 stackable



Rechnungstablett
bill presenter
porta cuenta
porte-addition
mit Klemme für Rechnung
with clip for bill
con clip para la nota
avec clip pour la note



	cm	↑ cm
30108	20 x 12	1,5



Rechnungstablett
bill presenter
porta cuenta
porte-addition
mit Klemme für Rechnung
with clip for bill
con clip para la nota
avec clip pour la note



	cm	↑ cm
30110	17 x 11	1



Tischkrümelentferner
crumber
recogemigas
ramasse-miettes



geschliffene Edelstahlkante, matt poliert, einfache Handhabung
flat grinded stainless steel edge, matt polished, easy to handle
geschliffene Edelstahlkante, pulido mate, fácil de usar, mango hueco
geschliffene Edelstahlkante, poli mat, manche creux, simple à utiliser

	Ø cm	↑ cm
00581	19,5 x 4,5	1



71400

Rezeptionsglocke
ring bell
timbre
sonnette



	Ø cm	↑ cm	Farbe / Colour
71400	8,5	6,0	■
71433	10,0	6,5	■



ASHTRAYS



00582 **black**

00583 **yellow**

00584 **turquoise**

00585 **white**

Windaschenbecher

ashtray
cenicero
cendrier



Metall verchromt, Glas gefrostet, mit Bajonettverschluss

metal chrome plated, glass frosted, bayonet lock

metal cromado, opaco mate, cierre de bayoneta

métal chromé, mat, verrouillage par baïonnette

	Ø cm	↑ cm	Farbe / Colour
00582	9,5	8	
00583	9,5	8	
00584	9,5	8	
00585	9,5	8	



00560 **white**

00561 **berry**

00562 **green**

00563 **blue**

00564 **black**

Windaschenbecher

ashtray
cenicero
cendrier



Metall verchromt, Glas gefrostet, mit Bajonettverschluss

metal chrome plated, glass frosted, bayonet lock

metal cromado, opaco mate, cierre de bayoneta

métal chromé, mat, verrouillage par baïonnette

	Ø cm	↑ cm	Farbe / Colour
00560	9,5	8	
00561	9,5	8	
00562	9,5	8	
00563	9,5	8	
00564	9,5	8	





NEW

Windaschenbecherashtray
cenicero
cendrier**Metall matt-schwarz, Glas gefrostet, mit Bajonettverschluss**metal matt black, glass frosted, with bayonet lock
metal negro mate, opaco mates, con cierre de bayoneta
métal noir mat, givré, verrouillage par baïonnette

	Ø cm	↑ cm	Farbe / Colour
00558	9,5	8	■

**Drehaschenbecher „PUSH“**ashtray
cenicero
cendrier**Deckel mit Drehmechanismus, mit Bajonettverschluss**with rotary button, bayonet lock
con botón giratorio, cierre de bayoneta
tourne par pression sur le bouton, verrouillage par baïonnette

	Ø cm	↑ cm
00568	9,5	11

**Drehmechanismus**
rotary button**Drehaschenbecher „KLASSIKER“**ashtray
cenicero
cendrier giratoire**Deckel mit Drehmechanismus**with rotary button
con botón giratorio
tourne par pression sur le bouton

	Ø cm	↑ cm	Farbe / Colour
00054	13,0	10,5	■
00056	10,5	11	■

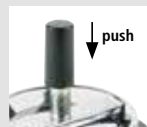
**Drehmechanismus**
rotary button**Windaschenbecher „ELEMENT“**ashtray
cenicero
cendrier**möbelschonende Unterseite**
non-scratching undersurface
base anti rayaduras
avec revêtement antirayures

	Ø cm	↑ cm	Farbe / Colour
00570	10,5	5,0	■
00559 <small>NEW</small>	10,5	5,0	■



Windaschenbecher

ashtray
cenicero
cendrier



Deckel hochglanzpoliert, Behälter matt poliert, mit Windschutzdeckel
lid mirror polished, container matt polished, with windcover
con tapa antiviento pulida brillante y contenedor pulido efecto pulido mate
couvercle anti-vent brillant, corps poli mat poli maté

	Ø cm	↑ cm
00052	12	5,5



Klappmechanismus
rotary button



00091

Windaschenbecher

ashtray
cenicero
cendrier



matt poliert, mit Windschutzdeckel
matt polished, with windcover
pulido mate apilable, tapa para el viento
poli mat, empilable, couvercle anti-vent

	Ø cm	↑ cm
00090	10	4,5
00091	12	4,5



stapelbar
stackable



83488

Windaschenbecher

ashtray
cenicero
cendrier



	Ø cm	↑ cm	Farbe / Colour
83488	11,5	5	■
83489	11,5	5	■



83611

Windaschenbecher

ashtray
cenicero
cendrier



	Ø cm	↑ cm	Farbe / Colour
83610	10	4,0	■
83612	12	4,5	■
83611	10	4,0	■
83613	12	4,5	■



Aschenbecher

ashtray
cenicero
cendrier



	Ø cm	↑ cm	Farbe / Colour
83616	9,5	4,5	■



Windaschenbecher „SMOKY“

ashtray
cenicero
cendrier

mit abnehmbarem Deckel
with removable lid
con tapa extraible
avec couvercle amovible



	Ø cm	↑ cm	Farbe / Colour	
00586	8,5	11,5		schwarz / black
00578	8,5	11,5		verzinkt / galvanised



Aschenbecher, 3er Set

ashtray, 3 pcs.
set de 3 cenicero
set de 3 cendriers



	Ø cm	↑ cm	Farbe / Colour	pcs.
00576	8	3		3



Aschenbecher

ashtray
cenicero
cendrier

matt poliert, hochwertige schwere Ausführung

matt polished, high quality, heavy gauge
pulido pulido mate, alta calidad, apilable
poli mat, empilable, belle qualité



	Ø cm	↑ cm
00048	8	3
00050	10	3



Standascher „DIABOLO“

standing ashtray
cenicero de pie
cendrier sur pied

für den Innen- und Außenbereich, inklusive 1,5 kg Sand, eine Ascheschale für die Sand-
befüllung und ein Metallsieb

for in,- outdoor use, included a bag of sand and a metal sieve
uso en interior o exterior, incluye una bolsa de arena y embudo de metal
usage en intérieur ou extérieur, livré avec un sac de sable et entonnoir métal



	Ø cm	↑ cm
00574	40	60



vielseitig nutzbar
versatile

zerlegbar und stapelbar
dismountable and stackable



Trittmechanismus
step on bin

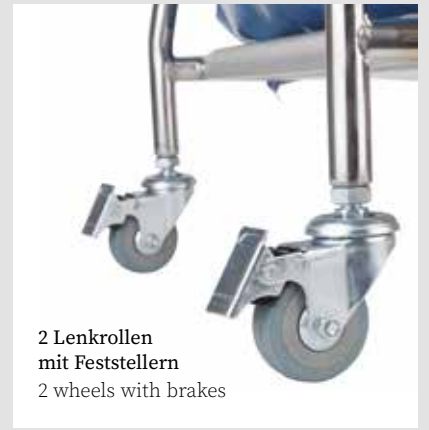

2 Lenkrollen
mit Feststellern
2 wheels with brakes



55 cm

82 cm

Gummilippe 55 cm breit, Abstand zwischen
Gummilippe und Bodenblech 82 cm

Tretbeutelhalter

pedal bin
soporte a pedal
poubelle à pédale

geeignet für Müllbeutel bis 120 ltr., 110 x 70 cm

suitable for bags up to 120 ltr., 110 x 70 cm

apto para bolsas hasta 120 l., medidas sin bolsa 110 x 70 cm

apte pour sacs de 120 l., dim. sans sac 110 x 70 cm



	cm	↑ cm
00580	59 x 43	96



leichte Bedienung, Trittmechanismus
easy handling, step on bin

Lunchbox



Lunchbox „M“ lunchbox fiambrella boîte à lunch



Edelstahlbox mit Silikondichtung inkl. Trennsteg, auslaufsicher

stainless steel box with silicone seal incl. divider, leak-proof

caja de acero inoxidable con junta de silicona y divisor extraíble, transporte sin salpicaduras

boîte en acier inox avec joint en silicone et diviseur amovible, transport sans éclaboussures

	cm	↑ cm	ltr.
66900	18,5 x 13,5	6,5	0,8



Lunchbox „L“ lunchbox fiambrella boîte à lunch



Edelstahlbox mit Silikondichtung inkl. Trennsteg, auslaufsicher

stainless steel box with silicone seal incl. divider, leak-proof

caja de acero inoxidable con junta de silicona y divisor extraíble, transporte sin salpicaduras

boîte en acier inox avec joint en silicone et diviseur amovible, transport sans éclaboussures

	cm	↑ cm	ltr.
66901	20,5 x 14,5	6,5	1,1



Lunchbox „XL“ lunchbox fiambrella boîte à lunch



Edelstahlbox mit Silikondichtung inkl. Trennsteg, auslaufsicher

stainless steel box with silicone seal incl. divider, leak-proof

caja de acero inoxidable con junta de silicona y divisor extraíble, transporte sin salpicaduras

boîte en acier inox avec joint en silicone et diviseur amovible, transport sans éclaboussures

	cm	↑ cm	ltr.
66902	22,5 x 16,5	6,5	1,4



mit zwei Verschlüssen
with 2 clasps

66900

0,8 ltr.



66901

1,1 ltr.



66902

1,4 ltr.

herausnehmbarer Trennsteg
removable divider



auslaufsicher | leak-proof







Kitchen & Servingttools

BANQUET	514
PROFI	516
CLASSIC	517
STOP TOOLS	518
POLYAMIDE KITCHENTOOLS	520
TONGS	522
TWEEZERS	529
TOOLTIME	530
CUTTERS WHISKS	537
STRAINERS	538
MEASURING CUPS.....	542
MOUSSE RINGS	543
CAKE SETTING RINGS DISPLAY TRAY	544
FUNNELS	546
SCOOPS	547
SQUEEZE BOTTLES	548
DISPENSERS EGG BOXES	550
SQUEEZERS	551
PIZZA	552
SPOONS WOOD	556

BANQUET



Die Vorlegeserie BANQUET ist die passende Ergänzung zum Servieren am Buffet. Durch die mattierte Oberfläche und das gebogene Griffende wird BANQUET praktischen und optischen Ansprüchen gerecht.

The series BANQUET is the perfect addition for serving at the buffet. Due to the matt surface and the curved handle, BANQUET meets practical and optical requirements.

La serie BANQUET es la adición perfecta para servir en el buffet. Debido a la superficie mate y al mango curvado, BANQUET cumple con requisitos prácticos y ópticos.

La série BANQUET est l'ajout parfait pour servir au buffet. Grâce à la surface mate et la poignée incurvée, BANQUET répond aux exigences pratiques et optiques.



Salat- / Servierlöffel „BANQUET“ salad spoon / serving spoon cuchara para ensalada / cuchara de servicio cuillère à salade / cuillère de service



	cm	Griff / handle cm
00588	6 x 5	17
00590	7,5 x 6	21



Salatgabel „BANQUET“ salad fork tenedor de servicio para ensalada fourchette de service pour la salade



	cm	Griff / handle cm
00589	6 x 5	17
00591	7,5 x 6	21



Schöpflöffel „BANQUET“ ladle cucharón louche



	cm	Griff / handle cm
00595	8,5 x 7,5	24



Chafing Dish Löffel „BANQUET“

serving spoon
cuchara para servir
cuillère de service



	cm	Griff / handle cm	
00592	11 x 6,5	24	
00593	11 x 6,5	24	geschlitzt / slotted



00593



Dressinglöffel „BANQUET“

dressing spoon
cuchara de aliño
cuillère à vinaigrette



	cm	Griff / handle cm
00594	6 x 4	30



Pfannenwender „BANQUET“

turner
espátula
spatule



	cm	Griff / handle cm
00587	10 x 7,5	21



Fleischgabel „BANQUET“

meat fork
tenedor de carne
fourchette à viande



	cm	Griff / handle cm
00596	8 x 2,5	13



Serviergabel „BANQUET“

fork
tenedor de servicio
fourchette de service



	cm	Griff / handle cm
00597	9 x 4	21



Tortenheber „BANQUET“

cake lifter
pala de tartas
pelle à gâteau
eine Kante gezahnt
one edge serrated
un borde serrado
denté sur un côté



	cm	Griff / handle cm
00598	14 x 6	13

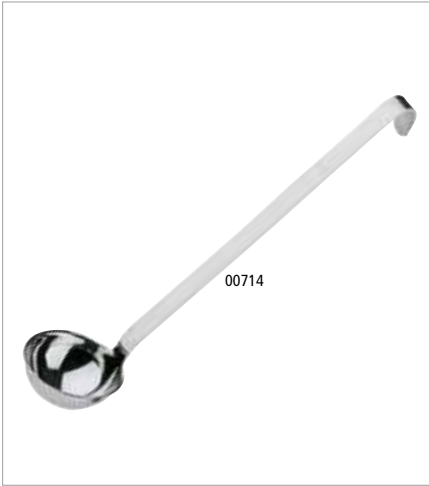

Schöpflöffel „PROFI“

ladle
cacillo
louche



	Ø cm	Griff / handle cm	ltr.
00711	6	28	0,050
00712	7	30	0,080
00713	8	32	0,125
00714	9	33	0,150
00715	10	35	0,250
00716	11	36	0,300



Schaumlöffel „PROFI“

skimmer
espumadera
écumoire



	Ø cm	Griff / handle cm
00721	10	34
00722	12	37
00723	14	40



Wender „PROFI“

turner
espátula
spatule



	cm	Griff / handle cm
00730	10 x 11,5	38



Servierlöffel „PROFI“

serving spoon
cuchara de servicio
cuillère de service



	cm	Griff / handle cm	
00671	11 x 7	29	
00672	11 x 7	29	geschlitzt / slotted



Spaghettilöffel „PROFI“

spaghetti spoon
cuchara de espaguetis
cuillère à spaghettis



	cm	Griff / handle cm
00673	10 x 7	29



Servierlöffel „CLASSIC“

serving spoon
cuchara de servicio
cuillère de service



hochglanzpoliert, perforiert, Löcher Ø 4 mm, ergonomisch profilierter Hohl-Griff
mirror polished, perforated, holes Ø 4 mm, ergonomic designed handle
pulido brillante agujeros de Ø 4 mm, asa ergonómica
brillant, trous Ø 4 mm, manche ergonomique

	cm	Griff / handle cm
75903	9,5 x 7	23,5



Salatlöffel „CLASSIC“

salad spoon
cuchara para ensalada
cuillère à salade



hochglanzpoliert, ergonomisch profilierter Hohl-Griff
mirror polished, ergonomic designed handle
pulido brillante, asa ergonómica
poli brillant, manche ergonomique

	cm	Griff / handle cm
75902	8 x 6	21,5
75904	9,5 x 7	23,5



Suppenkelle „CLASSIC“

soup ladle
cucharón de sopa
louche de service



hochglanzpoliert, ergonomisch profilierter Hohl-Griff
mirror polished, ergonomic designed handle
pulido brillante, asa ergonómica
poli brillant, manche ergonomique

	Ø cm	Griff / handle cm	ltr.
75907	7	23	0,06
75908	9	24	0,1



Saucengießlöffel „CLASSIC“

sauce / gravy ladle
cucharón de salsa
cuillère à sauce



hochglanzpoliert, ergonomisch profilierter Hohl-Griff, fugenlos
mirror polished, ergonomic designed handle, seamless
pulido brillante, asa ergonómica, sin soldadura
poli brillant, manche ergonomique, monobloc (sans soudure)

	cm	Griff / handle cm	ltr.
75906	7 x 5,5	22	0,02



Tortenheber „CLASSIC“

cake lifter
pala de tartas
pelle à gâteau



hochglanzpoliert, mit einer gezahnten Kante, ergonomisch profilierter Hohl-Griff
mirror polished, one edge serrated, ergonomic designed handle
pulido brillante, canto dentado, mango ergonómico
poli brillant, bord microdenté, manche ergonomique

	cm	Griff / handle cm
75900	8 x 5	10,5
75912	5 x 1	12

STOP-TOOLS

Die STOP-Funktion verhindert, dass Gabel oder Löffel in das Gefäß rutschen.

The smart STOP-function prevent forks and spoon not to slip into the vessel.

La función STOP evita que los cubiertos se caigan dentro del recipiente.

La fonction STOP empêche les couverts de glisser dans le récipient.



STOP Funktion



Servierlöffel

serving spoon
cuchara para servir
cuillère à servir



Materialdicke 2,5 mm, ergonomischer, rutschfester Griff
material thickness: 2,5 mm, ergonomic antislip handle
grosor: 2,5 mm, mango ergonómico antideslizante
épaisseur : 2,5 mm, poignée ergonomique antidérapante

	cm	Griff / handle cm
00834	10 x 7,5	17



Servierlöffel geschlitzt

slotted spoon
cuchara para servir ranurada
cuillère à servir rainurée



Materialdicke 2,5 mm, ergonomischer, rutschfester Griff
material thickness: 2,5 mm, ergonomic antislip handle
grosor: 2,5 mm, mango ergonómico antideslizante
épaisseur : 2,5 mm, poignée ergonomique antidérapante

	cm	Griff / handle cm
00833	10 x 7,5	17



Schöpflöffel

ladle
cucharón
louche



Materialdicke 2,5 mm, ergonomischer, rutschfester Griff
material thickness: 2,5 mm, ergonomic antislip handle
grosor: 2,5 mm, mango ergonómico antideslizante
épaisseur : 2,5 mm, poignée ergonomique antidérapante

	Ø cm	Griff / handle cm
00832	9	17



Fleischgabel

meat fork
tenedor de carne
fourchette à viande



Materialdicke 2,5 mm, ergonomischer, rutschfester Griff
material thickness: 2,5 mm, ergonomic antislip handle
grosor: 2,5 mm, mango ergonómico antideslizante
épaisseur : 2,5 mm, poignée ergonomique antidérapante

	cm	Griff / handle cm
00831	10,5 x 4	17

**Servierlöffel geschlitzt**

slotted spoon

cuchara para servir ranurada

cuillère à servir rainurée

ergonomischer, rutschfester Griff

ergonomic antislip handle

mango ergonómico antideslizante

poignée ergonomique antidérapante



	cm	Griff / handle cm
00664	11 x 7	25

**Servierlöffel**

serving spoon

cuchara para servir

cuillère à servir

ergonomischer, rutschfester Griff

ergonomic antislip handle

mango ergonómico antideslizante

poignée ergonomique antidérapante



	cm	Griff / handle cm
00662	11 x 7	25

**Schöpföffel**

ladle

cucharón

louche

ergonomischer, rutschfester Griff

ergonomic antislip handle

mango ergonómico antideslizante

poignée ergonomique antidérapante



	cm	Griff / handle cm	ltr.
00670	9 x 8	25	0,10

**Wender**

turner

espátula

spatule

ergonomischer, rutschfester Griff

ergonomic antislip handle

mango ergonómico antideslizante

poignée ergonomique antidérapante



	cm	Griff / handle cm
00668	10 x 8	25

**Fleischgabel**

meat fork

tenedor de carne

fourchette à viande

ergonomischer, rutschfester Griff

ergonomic antislip handle

mango ergonómico antideslizante

poignée ergonomique antidérapante



	cm	Griff / handle cm
00666	10 x 3,5	25

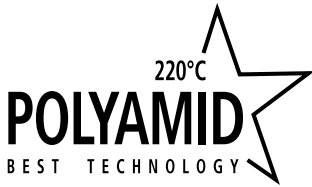

Das Profimaterial Polyamid besteht aus Nylon und Fiberglas. Hitzebeständig bis 220°C, extra hochwertige Profi-Qualität, gut geeignet für antihafbeschichtete Pfannen, ergonomischer Griff.

Polyamide is made of nylon and fiberglass. Heat-resistant up to 220°C, extra high quality, perfect for non-stick-coated pots and pans, ergonomic handle.

Polyamide de nylon y fibra de vidrio. Brevemente al calor hasta 220°, calta calidad profesional, ideal para sartenes antiadherentes, mango ergonómico.

Polyamide de nylon et fibre de verre, haute résistance brièvement à la chaleur jusque 220°C, qualité professionnelle, idéal pour les poêles antiadhérentes, manche ergonomique.



Bratenwender
turner
espátula
spatule



	cm	Griff / handle cm
00603	11 x 9,5	23



Pfannenwender
turner
espátula
spatule



	cm	Griff / handle cm
00600	11,5 x 9,5	23



Pfannenwender
turner
espátula
spatule



	cm	Griff / handle cm
00604	15 x 7,5	15



Pfannenwender
turner
espátula
spatule



	cm	Griff / handle cm
88642	13,5 x 9	18



Pfannenwender
turner
espátula
spatule



	cm	Griff / handle cm
88640	13 x 6,5	15



Servierlöffel
 serving spoon
 cuchara de servicio
 cuillère de service



	cm	Griff / handle cm	
88608	12 x 7	23	
00607	12 x 7	23	perforiert



Schaumlöffel
 skimmer
 espumadera
 écumoire



	Ø cm	Griff / handle cm
00602	11,5	23



Schöpflöffel
 ladle
 cucharón
 louche



	Ø cm	Griff / handle cm	ltr.
00606	9	23	0,1



Spaghettizange
 spaghetti tongs
 pinzas para espaguetis
 pince à spaghettis



	cm	Griff / handle cm
88637	9 x 9	15



Toastzange
 sandwich tongs
 pinzas para sandwich
 pince à toasts



	cm	Griff / handle cm
00601	11 x 8	18



Salatzange
 salad tongs
 pinzas para ensalada
 pince à salade



	cm	Griff / handle cm
00629 <small>new</small>	8 x 5,5	17,5
00605	10 x 6	23



Universalzange
all-purpose tongs
pinzas multiusos
pince multi-usages



Griff matt beschichtet / matt coated handle / mango recubierto de mate / poignée revêtue de mat

	→ cm	Farbe / Colour
75860	24	gelb
75861	24	rot
75862	24	grün
75863	24	blau
75864	24	schwarz

HACCP Farbkennzeichnung Konzept
HACCP color coding concept



matte Antirutschummatellung
matt anti-slip coating



Universalzange
all-purpose tongs
pinzas multiusos
pince multi-usages



Griff matt beschichtet / matt coated handle / mango recubierto de mate / poignée revêtue de mat

	→ cm	Farbe / Colour
75865	30	gelb
75866	30	rot
75867	30	grün
75868	30	blau
75869	30	schwarz

HACCP Farbkennzeichnung Konzept
HACCP color coding concept



matte Antirutschummatellung
matt anti-slip coating



Universalzange
all-purpose tongs
pinza universal
pince universelle



	cm	→ cm	Farbe / Colour	€
75825	7 x 5	22,5	vintage-look	
75830	7 x 5	25	mirror polished	
75831	7 x 5	25	gold-look	
75832	7 x 5	25	copper-look	



Universalzange
all-purpose tongs
pinza universal
pince universelle



hochglanzpoliert, mit Befestigungsclip
mirror polished, with fastening clip
pulido brillante, con clip de fijación
poli brillant, avec clip de fixation

	→ cm	Farbe / Colour
75850	19,5	mirror polished
75851	19,5	copper-look
75852	19,5	gunmetal-look



Zange kann an einer Schale befestigt werden
tongs can be attached to a bowl



Eiszange
ice tongs
pinzas para hielo
pince de la glace



hochglanzpoliert, mit Befestigungsclip
mirror polished, with fastening clip
pulido brillante, con clip de fijación
poli brillant, avec clip de fixation

	→ cm	Farbe / Colour
75853	20	mirror polished
75854	20	copper-look
75855	20	gunmetal-look



Zange kann an einer Schale befestigt werden
tongs can be attached to a bowl



Universalzange

all-purpose tongs
pinza universal
pince universelle

Edelstahl, Antik-Edelstahl-Look / Vintage-Look

stainless steel, stainless antique look
acero inoxidable, acero estilo antiguo
acier inox, acier style antique



	cm	→ cm	Farbe / Colour	
75823	5,5 x 5,0	20,0		vintage-look
75824	7,0 x 5,0	22,5		vintage-look



Vorspeisenzange „BANQUET“

appetizer tongs
pinza para aperitivos
pince à apéritif

Vorderteil poliert, Stiel mattiert

front part: high-shiny, handle: matt-finish
parte delantera pulida, asa mate
partie avant polie, poignée matte



	cm	→ cm
75822	4,5 x 3,5	20



ideal für Vorspeisen
ideal for starters



Salatzange

salad tongs
pinza ensalada
pince à salade

hochglanzpoliert, beidseitig geschlitzt / mirror polished, slotted on both side
pulido brillante, agujereada en 2 lados / poli brillant, perforéedes 2 côtés



	cm	→ cm
75801	5 x 2	24



Spaghettizange

spaghetti tongs
pinza espaguetis
pince à spaghettis

hochglanzpoliert, fugenlos

mirror polished, seamless
pulido brillante, sin soldaduras
poli brillant, monobloc



	cm	→ cm
75810	6 x 3	19



Gebäckzange

pastry tongs
pinza para pasteles
pinçe à gâteaux

hochglanzpoliert, fugenlos, extra schwere Qualität

mirror polished, seamless, extra heavy gauge
pulido brillante, sin soldadura, alta calidad, resistente
poli brillant, monobloc, qualité extra, robuste



	cm	→ cm
75807	8,5 x 4	27,5



Universalzange

all - purpose tongs
pinza universal
pinçe universelle

hochglanzpoliert, einseitig geschlitzt

mirror polished, slotted on one side
pulido brillante, agujereada en un lado
poli brillant, perforée d'un seul côté



	cm	→ cm
75800	5 x 2	24



Allzweckzange

multipurpose tongs
pinza multi-usos
pinçe universelle multi-usages

hochglänzend, mit Feder und Verschlusschieber, dekorative Greiferform

mirror polished, with spring and retaining clip, decorative gripper form
pulido brillante, con muelle y cierre deslizante, gancho con forma decorativa
poli brillant, avec mécanisme de verrouillage, forme de pince décorative



	cm	→ cm
88643	4 x 3	24
88644	4 x 3	30
88645	4 x 3	40



Aufschnitt- / Allzweckzange

sausage tongs
pinza salchichas
pinçe à saucisses

hochglanzpoliert, fugenlos

mirror polished, seamless
pulido brillante, sin soldadura
poli brillant, monobloc



	cm	→ cm
75806	3 x 2,5	16



Salatzange „TIDLOS“

salad tongs
pinza ensalada
pince à salade

hochglanzpoliert, einseitig geschlitzt
mirror polished, slotted on one side
pulido brillante, agujereada en un lado
poli brillant, perforée d'un seul côté



	cm	→ cm
75842	5 x 2	22



Pastazange „TIDLOS“

pasta tongs
pinza espaguetis
pince à spaghettis

hochglanzpoliert, beidseitig geschlitzt
mirror polished, slotted on both side
pulido brillante, agujereada en 2 lados
poli brillant, perforéedes 2 côtés



	cm	→ cm
75843	8 x 5,5	22,5



Spargelzange „TIDLOS“

asparagus tongs
pinzas para espárragos
pince à asperges

hochglanzpoliert / mirror polished / pulido brillante / poli brillant



	cm	→ cm
75844	7 x 11	24,5



Gebäckzange „TIDLOS“

pastry tongs
pinza para pasteles
pince à gâteaux

hochglanzpoliert / mirror polished / pulido brillante / poli brillant



	cm	→ cm
75840	6,5 x 4,5	21



Servierzange „TIDLOS“

serving tongs
pinza universal
pince universelle

hochglanzpoliert / mirror polished / pulido brillante / poli brillant



	cm	→ cm
75841	7 x 4,5	21



Salatzange

salad serving tongs
pinza de ensalada
pinçe à servir la salade

hochglanzpoliert, einfache Handhabung

mirror polished, convenient handling
pulido brillante, manejo cómodo
poli brillant, manipulation aisée



	cm	→ cm
00685	7,0 x 4,5	25



Universalzange

all - purpose tongs
pinzas multiusos
pinçe multi-usages

hochglanzpoliert, einfache Handhabung

mirror polished, convenient handling
pulido brillante, manejo cómodo
poli brillant, manipulation aisée



	cm	→ cm
00688	7,0 x 4,5	25



Brot- und Gebäckzange

bread and pastry tongs
pinza para pan y bollería
pinçe à pain ou viennoiseries

hochglanzpoliert, einfache Handhabung

mirror polished, convenient handling
pulido brillante, manejo cómodo
poli brillant, manipulation aisée



	cm	→ cm
00686	7,0 x 4,5	25



Brot- und Gebäckzange

bread and pastry tongs
pinza para pan y bollería
pinçe à pain ou viennoiseries

hochglanzpoliert, einfache Handhabung

mirror polished, convenient handling
pulido brillante, manejo cómodo
poli brillant, manipulation aisée



	cm	→ cm
00687	7,0 x 4,5	25



Gebäckzange

pastry tongs
pinza para pasteles
pince à gâteaux

hochglanzpoliert, perforiert
mirror polished, perforated
pulido brillante, perforado
poli brillant, perforée



	cm	→ cm
75804	6,5 x 3	19,5



Gebäck- / Tortenzange

pastry tongs
pinza para pasteles
pince à gâteaux

hochglanzpoliert, fugenlos
mirror polished, seamless
pulido brillante, sin soldadura
poli brillant, monobloc



	cm	→ cm
75803	7 x 3,5	17,5



Eisportionierer

ice cream scoop
cuchara para helado
cuillère à glace

hochglanzpoliert, mit Edelstahlfeder (physikalisch bedingt nicht korrosionsbeständig)
mirror polished, spring steel, spring is not stainless
pulido brillante, muelle de acero especial, no resistente al óxido
poli brillant, ressort acier spécial, non résistant à l'oxydation



	Ø cm	→ cm	ltr.
71006	6,5	23,5	1/12
71005	6,0	22,5	1/16
71004	5,5	22,0	1/20
71003	5,0	22,0	1/24
71002	5,0	21,5	1/30
71001	4,5	21,0	1/36

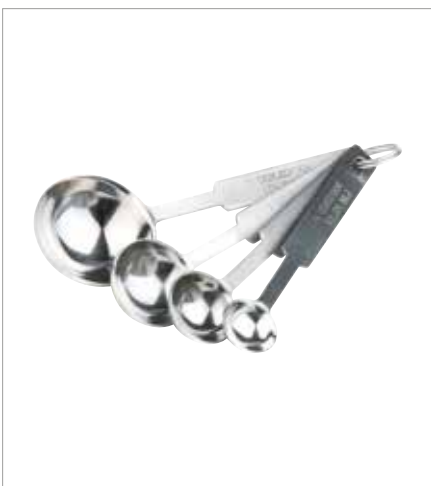

Messlöffelsatz

set measuring spoon
juego de cucharas medidoras
jeu de cuillère à mesure

Löffel hochglanzpoliert, Stiele matt poliert, Skalierung:
1 Esslöffel, 1 Teelöffel, 1/2 Teelöffel, 1/4 Teelöffel

bowl mirror polished, handles matt polished, measures:
table spoon, tea spoon, 1/2 tea spoon, 1/4 tea spoon

bol medidor brillante, mango mate medidas:

1 cuchara de sopa, 1 cuchara de té, 1/2 cuchara de té, 1/4 cuchara de té

corps brillant, manche mat, mesures:

1 cuillerée à soupe, 1 cuillerée à thé, 1/2 cuillère à thé, 1/4 de cuillère à thé



	cm
75600	14 x 4,5



Pinzettenzange

fine tongs / tweezer
pinza de emplatar
pince à dresser

hochglanzpoliert, geriffelte Grifffläche, schwere Qualität

mirror polished, ribbed handle, heavy gauge
pulido brillante, mango cómodo ranurado, alta calidad
poli brillant, manche rainuré antiglisse, qualité extra



→ cm

75820 16



Pinzettenzange

fine tongs / tweezer
pinza de emplatar
pince à dresser

hochglanzpoliert, geriffelte Grifffläche, schwere Qualität

mirror polished, ribbed handle, heavy gauge
pulido brillante, mango cómodo ranurado, alta calidad
poli brillant, manche rainuré antiglisse, qualité extra



→ cm

75821 30



Pinzettenzange

fine tongs / tweezer
pinza de emplatar
pince à dresser

hochglanzpoliert, geriffelte Grifffläche, schwere Qualität

mirror polished, ribbed handle, heavy gauge
pulido brillante, mango cómodo ranurado, alta calidad
poli brillant, manche rainuré antiglisse, qualité extra



→ cm

75809 30



Pinzettenzange

fine tongs / tweezer
pinza de emplatar
pince à dresser

hochglanzpoliert, geriffelte Grifffläche, abgerundete Spitzen vorne, schwere Qualität

mirror polished, ribbed handle, rounded on the tops, heavy gauge
pulido brillante, mango cómodo ranurado, alta calidad, puntas redondeadas
poli brillant, manche rainuré antiglisse, qualité extra, pointes arrondies



→ cm

75808 14,5

TOOLTIME



Kugelausstecher - doppelt „TOOLTIME“

melon baller - double
vaciador doble de bola
moule à boule double



zum Formen von Kugeln aus Obst, Gemüse oder Butter, Edelstahl mit geschärften Rändern
to form balls out of fruits, vegetables, butter, etc., stainless steel with sharpened edge
para hacer bolas con frutas, verduras, mantequilla, etc. acero inoxidable con borde afilado
pour faire des boules de fruits, légumes, beurre, etc. inox, bord affûté

	∅ cm	→ cm
88810	2,2 + 2,5	16,5
88811	2,2 + 3,0	17



Fadenschneider / Zester „TOOLTIME“

decorator / zester
cuchillo de decoración cincelador
couteau zesteur



zum Abziehen von feinsten Schalenstreifen, ideal zum Dekorieren von Torten und Desserts
to peel off very fine stripes of paring, these stripes are ideal to decorate desserts, cakes, etc.
para pelar tiras muy finas, ideal para decorar postres, tartas, etc.
pour couper en lanières fines, idéal pour la décoration de gâteaux et desserts, etc.

	∅ cm	→ cm
88823	0,2 + 0,5	14,5



Ziseliernesser „TOOLTIME“

canele / decorating knife
cuchillo de decoración cincelador acanalado
couteau zesteur cannelé



zum Einritzen von Linien und Mustern in hartschaliges Obst und Gemüse, Edelstahl mit geschärften Rändern

to score lines or design in hard fruits and vegetables, stainless steel with sharpened edge
para dibujar líneas en frutas o verduras de piel dura, acero inoxidable con borde afilado
pour découper des lignes et motifs sur fruits et légumes à peau dure ou pour peler les zestes des citrons ou oranges, inox, bord affûté

→ cm

88826

15



Sparschäler „TOOLTIME“

peeler
pelador
peleur



für Links- und Rechtshänder geeignet, mit zwei starren Klingen aus extra geschärftem + gehärtetem Edelstahl

useable left- and right handed, with 2 inflexible blades made out off sharpened, extra hardened stainless steel

para diestros y zurdos, con 2 cuchillas rígidas inox afiladas y muy resistentes
pour gauchers ou droitiers, 2 lames rigides affûtés en inox extra-résistant

→ cm

88827

17



Pendelschäler „TOOLTIME“

swivel peeler
pelador reversible
éplucheur droitier/gaucher



für Links- und Rechtshänder, ideal für das Schälen von Tomaten, mit 2 beweglichen Klingen

suitable for right and left handed, ideal to peel tomatoes, with 2 flexibles blades

apto para diestros y zurdos, ideal para pelar tomates, con 2 hojas flexibles

pour gauchers ou droitiers, idéal pour peler les tomates, 2 lames flexibles

→ cm

88850

16,5



Cocktailmesser „TOOLTIME“

bar knife
cuchillo para cóctel
couteau cocktail



mit 2 Zinken zum Aufspießen von Zitrusseiben

with 2 prongs to pick up slices of lemon

con 2 dientes para pinchar las rodajas de limón, etc.

avec 2 dents pour les rondelles de citron et autres décorations

→ cm

88846

21



Pizzateigschneider „TOOLTIME“

pizza cutter
cortador de pizza
roulette à pizza

zum einfachen Zerteilen von Pizza
to cut pizza easily
para cortar pizza fácilmente
pour une coupe facile de la pizza



	Ø cm	→ cm
88829	6	18,5



Pendelschäler „TOOLTIME“

swivel peeler
pelador lama pivotante
peleur lame pivotante

zum schnellen und sparsamen Schälen von Obst und Gemüse, mit beweglicher Klinge
to peel fruits and vegetables with flexible blade
para pelar frutas y verduras con hoja flexible
pour couper des fruits et légumes avec lame flexible



	→ cm
88834	17



Apfelentkerner „TOOLTIME“

apple corer
descorazonador de manzana
vide-pomme

durch leichtes Drehen kann das Kerngehäuse von Äpfeln, Birnen und anderen Früchten sorgsam herausgeholt werden, Edelstahl mit geschärften Rändern
with a light turn cores of apples, pears and other fruits can be cut off easily, stainless steel with sharpened edge
para descorazonar muy fácilmente manzanas, peras y otras frutas
pour évider facilement les pommes, poires ou autres fruits



	Ø cm	→ cm
88836	2,2	21



Austernöffner „TOOLTIME“

oyster knife
abre ostras
couteau à huîtres

zum einfachen Aufbrechen von Austern, mit Fingerschutz, Edelstahl mit geschärften Rändern
to open oysters easily, with guard, stainless steel with sharpened edge
para abrir ostras fácilmente con protección para los dedos, acero inoxidable con punta afilada
pour ouvrir facilement les huîtres avec protection pour les doigts, inox, pointe affûtée



	→ cm
88839	14,5

**Austernmesser „TOOLTIME“**

oyster knife
 abre ostras
 couteau à huîtres

Edelstahlklinge zum Einstechen in die Schale, mit Fingerschutz

to open oysters easily, with guard
 para abrir ostras fácilmente con protección para los dedos
 pour ouvrir facilement les huîtres avec protection pour les doigts



→ cm

88840

15

**Dekoriermesser „TOOLTIME“**

decorating knife „cannelé“
 cuchillo acanalador
 couteau cannelé

gezahnte Klinge aus geschärftem Edelstahl

serrated sharpened blade, stainless steel
 hoja de sierra afilada, acero inoxidable
 lame inox microdentée



→ cm

88843

19

**Käsehobel „TOOLTIME“**

cheese slicer
 rebanador de queso
 couteau tranche-fromage

zum Schneiden von dünnen Käsescheiben

to cut thin slices of cheese
 para cortar lonchas finas de queso
 pour couper de fines tranches de fromage



→ cm

88853

21,5



Streichpalette „TOOLTIME“

spatula
espátula
spatule

flexible Edelstahlklinge, rutschfester Griff, hitzebeständig

flexible blade stainless steel, non-slip handle, heat-resistant

hoja flexible acero inoxidable mango polipropileno termoresistente anti-deslizante

lame inox flexible, manche antiglisse en polypropilène thermorésistant



	cm	→ cm
88920	35 x 5	48,5
88921	30,5 x 4,5	43,5
88922	25 x 4	38,0
88923	20 x 3	33,5



Winkelpalette „TOOLTIME“

spatula
espátula
spatule

flexible Edelstahlklinge

flexible blade stainless steel

hoja flexible acero inoxidable

lame inox flexible



	cm	→ cm
88928	17 x 5	30



Gebäckpalette „TOOLTIME“

pastry spatula
paleta pastelera
spatule pâtissière

flexible Edelstahlklinge

flexible blade stainless steel

hoja flexible acero inoxidable

lame inox flexible



	cm	→ cm
88932	17 x 7,5	29,5



Wender „TOOLTIME“

turner
espátula
spatule

flexible Edelstahlklinge

flexible blade stainless steel

hoja flexible acero inoxidable

lame inox flexible



	cm	→ cm
88933	15 x 6	27,5



Winkelpalette „TOOLTIME“

turner
espátula
spatule

flexible Edelstahlklinge
flexible blade stainless steel
hoja flexible acero inoxidable
lame inox flexible



	cm	→ cm
88935	34 x 5	47,5
88937	24 x 4	36
88938	18,5 x 3	32



Wender „TOOLTIME“

turner
espátula
spatule

flexible Edelstahlklinge
flexible blade stainless steel
hoja flexible acero inoxidable
lame inox flexible



	cm	→ cm
88939	24 x 7,5	37,5



Wender „TOOLTIME“

turner
espátula
spatule

perforiert, flexible Edelstahlklinge
perforated, flexible blade stainless steel
hoja flexible inox agujereada
lame ajourée inox flexible



	cm	→ cm
88940	24,5 x 7,5	37,5



Wender „TOOLTIME“

turner
espátula para plancha
spatule

flexible Edelstahlklinge
flexible blade stainless steel
hoja flexible acero inoxidable
lame inox flexible



	cm	→ cm
88941	20 x 7,5	33
88942	15 x 9	28



Spachtel / Schaber „TOOLTIME“

scraper
 espátula plancha
 spatule coudée spéciale grill

starre Edelstahl Klinge
 rigid blade stainless steel
 hoja rígida acero inoxidable
 lame inox rigide



	cm	→ cm
88929	11 x 10	25



Spachtel / Fettabstecher „TOOLTIME“

scraper
 espátula plancha
 spatule coudée spéciale grill

starre Edelstahl Klinge
 rigid blade stainless steel
 hoja rígida de acero inoxidable
 lame rigide inox



	cm	→ cm
88946	17 x 10	30
88947	15 x 7,5	28



Aufstrichmesser „TOOLTIME“

sandwich knife
 cuchillo para untar
 couteau à tartiner

flexible Edelstahl Klinge
 flexible blade stainless steel
 hoja flexible acero inoxidable
 lame inox flexible



	cm	→ cm
88948	8,5 x 3	18,5



Teigschaber / Abstecher „TOOLTIME“

dough scraper
 corta pasta
 coupe-pâte

starre Edelstahl Klinge
 rigid blade stainless steel
 hoja rígida de acero inoxidable
 lame rigide inox



	cm
88930	15,5 x 8



Pizzaschneider „TOOLTIME“

pizza cutter
cortador de pizza
coupe-pizza

ergonomischer Griff
ergonomic handle
mango ergonómico
manche ergonomique



	Ø cm	→ cm
88949	10	20



Eierschneider

egg cutter
corta huevos
coupe-oeufs

zum Längs- und Querteilen von hart gekochten Eiern
to cut hard-boiled eggs
corta a rodajas un huevo duro
en rondelles



	cm	↑ cm
88099	14,5 x 8	2,5



Hummerbrecher

lobster cracker
pinza bogavante
pince à homard



	cm
74201	14 x 5,5



Schneebeesen

whisk
batidor
fouet



	Drähte / wires	→ cm
00744	8	28
00745	8	33
00746	8	38
00747	8	43
00740	8	48



STRAINERS



Passiersieb

strainer
colador
passoire



feines Siebgewebe mit ca. 6 Löchern pro 1 cm²

fine mesh with 6 holes per 1 cm²

malla fina con 6 agujeros por 1 cm²

toile fine avec 6 trous pour 1 cm²

	Ø cm	→ cm
88618	30,0	60,0
88639	33,5	62,5



Passiersieb

strainer
colador
passoire



feines Siebgewebe mit ca. 6 Löchern pro 1 cm²

fine mesh with 6 holes per 1 cm²

malla fina con 6 agujeros por 1 cm²

toile fine avec 6 trous pour 1 cm²

	Ø cm	→ cm
74700	14	30
74701	16	32
74702	18	34
74703	20	36
74705	24	41
74706	26	43



Passiersieb, 3er Set

strainer, 3 pcs.
colador, set de 3
passoire, set de 3



3-teiliges Set bestehend aus 3 Sieben:

Ø 8,5 cm, L: 22,5 cm / Ø 14,5 cm, L: 32 cm / Ø 19,5 cm, L: 38,5 cm

set of 3 consisting of 3 sieves:

Ø 8,5 cm, L: 22,5 cm / Ø 14,5 cm, L: 32 cm / Ø 19,5 cm, L: 38,5 cm

set de 3 que consta de 3 tamices:

Ø 8,5 cm, L: 22,5 cm / Ø 14,5 cm, L: 32 cm / Ø 19,5 cm, L: 38,5 cm

set de 3 composé de 3 tamis :

Ø 8,5 cm, L: 22,5 cm / Ø 14,5 cm, L: 32 cm / Ø 19,5 cm, L: 38,5 cm

	Ø cm	→ cm
74707	8,5/14,5/19,5	22,5/33/38,5

**Passiersieb**

strainer
colador
passoire



mit Doppelnetz, Netz außen: ca. 2 Löcher pro 1 cm, Netz innen: ca. 5 Löcher pro 1 cm
with double mesh, outer mesh about 2 holes per cm, inner mesh about 5 holes per cm
con malla doble, malla exterior aprox. 2 agujeros /cm, interior aprox. 5 agujeros /cm
avec double étamine, extérieure env. 2 trous/cm, intérieure environ 5 trous/cm

	Ø cm	→ cm
74721	19,5	41,0
74722	24,5	56,5

**Barsieb**

bar strainer
colador de cóctel
tamis cocktail



	Ø cm	↑ cm	Griff / handle cm
93318	8,5	5	11,5

**Gazespitzsieb**

conical strainer with wire gauze
colador chino de malla
chinois renforcé avec maille fine



hochglanzpoliert, mit rundem Hohlgriff, ca. 9 Löcher pro 1 cm²
mirror polished, 9 holes per 1 cm²
pulido brillante, mango hueco, 9 agujeros por 1 cm²
poli brillant, manche creux, 9 trous pour 1 cm²

	Ø cm	↑ cm	Griff / handle cm
88717	25	19	24

**Spitzsieb**

conical strainer
colador cónico
chinois



mit Lochung Ø 1,5 mm, auch in der Kegelspitze, mit Flachstiel, mit Stützstiel zum
Einhaken in den Topfrand

with Ø 1,5 mm holes (including the tip), with flat handle, with supporting hook
con agujeros finos de Ø 1,5 mm (incluida la punta), con mango plano y gancho
perforations fines 1,5 y compris à la pointe, manche plat et crochet

	Ø cm	↑ cm	Griff / handle cm
00771	23	18	16,5

**Back- / Frittierlöffel**

skimmer / spider
espumadera para fritos
écumoire à friture



elektropoliert, sehr stabile Ausführung

electro polished, heavy gauge
electro pulido, alta calidad
poli électrolythique, qualité extra

	Ø cm	→ cm
74402	16	48
74404	20	54

STRAINERS



Seiher strainer colador passoire



2 Griffe: je 2 cm / 2 handles: each 2 cm / 2 asa: 2 cm cada una / 2 poignées: 2 cm chacune

	Ø cm	↑ cm	Farbe / Colour
00786	27,5	12	White
00787	27,5	12	Black



Seiher strainer colador passoire



mit 2 Muschelgriffen / with 2 shell shaped grips / con dos asas / à 2 anses moulées

	Ø cm	↑ cm
00780	36	19



Pommes-Frites-Seiher fry dripping tray escurridor de fritos égouttoir à friture



herausnehmbarer Locheinsatz, mit Handgriff
removable drainer, with handle
fondo de colador desmontable, con asa
fond démontable, avec poignée

	Ø cm	↑ cm
00785	39	19



Salzstreuer salt shaker salero salière



Pommes-Frites Streuer mit Schraubkappe
for french fries, cover to screw
para patatas fritas, tapa de rosca
pour les frites, couvercle à visser

	Ø cm	↑ cm	
00772	8	17	stainless steel
00779	8	17	aluminium



Wasserbadschüssel
bain marie bailing bowl
cazo para baño maría
réceptier bain-marie



hochglanzpoliert, mit Drahtgriff Ø 5 mm
mirror polished, with wire handle Ø 5 mm
pulido brillante, mango varilla Ø 5 mm
poli brillant, manche fil épaisseur Ø 5 mm

	Ø cm	↑ cm	Griff / handle cm	litr.
74731	18	9	15	1,5



Anwendungsbeispiel, Topf ≥ 20 cm
Application Example, pot ≥ 20 cm



Saucen- und Fondanttrichter
sauce and confectionary funnel
embudo para salsa y confitería
entonnoir à sauce et confiserie



ergonomischer Griff, Maßskalierung innen, mit 3 Düsen Ø 4, 5, 6 mm, inklusive Ständer und Auffangschale
ergonomic handle, scaling inside, with 3 different nozzles Ø 4, 5, 6 mm, including wire rack a. dripping dash
mango ergonómico, escalado interior, con 3 boquillas, Ø 4, 5, 6 mm, incl. pie de alambre y bandeja recoge gotas
manche ergonomique, mise à l'échelle à l'intérieur, 3 douilles de Ø 4, 5 et 6 mm, inclut pied avec ramasse-gouttes

	Ø cm	↑ cm	litr.
77338	21	31,5	1,5



Anwendungsbeispiel
application example



Maßskalierung innen
scaling inside



Gemüsehobel, Mandoline
mandolin
mandolina
mandoline



mit 7 verschiedenen Klingen (Breite 10 cm), Anti-Rutsch-Gestell, Schutzabdeckung
with 7 interchangeable blades (width 10 cm), non-slip folding stand, safety guard
con 7 cuchillas intercambiables (corte 10 cm), pie plegable anti-deslizante, carro de seguridad
7 peignes interchangeables (largeur 10 cm), pied repliable anti-glisse, chariot

	cm	↑ cm
88688	40,5 x 12	5 / 25



A 7 verschiedene Klingen
7 interchangeable blades
B Praktische Transportbox
Practical transport box

MEASURING CUPS

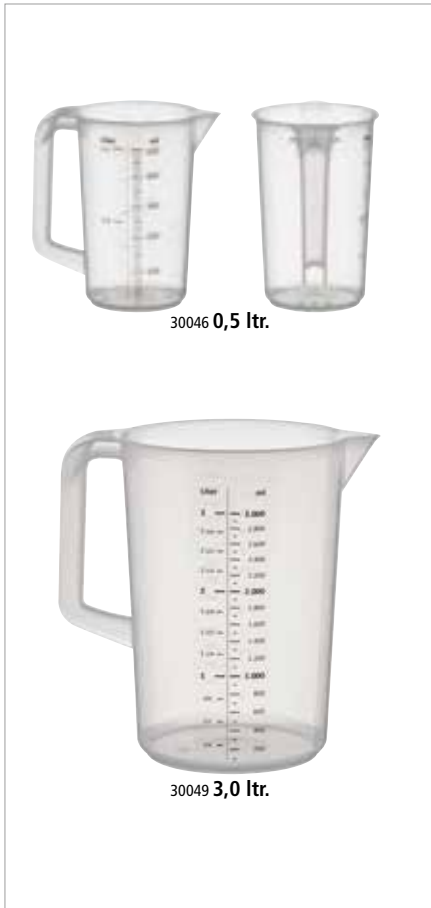

Messbecher „PRO“

measuring cup
jarra graduada
pichet gradué



mit geschlossenem Griff, mit geprägter Maßskalierung außen, l- und ml-Liter-Einteilung
with closed handle, with stamped printed liter and ml scale
con asa cerrada, con escala estampada de litros y ml
avec poignée fermée, avec échelle en litres et ml imprimée et tamponnée

	Ø cm	↑ cm	ltr.
30046	9	14	0,5
30047	12	16,5	1,0
30048	15	20,5	2,0
30049	17	23,5	3,0
30057	20	25,5	5,0



einfaches Eingießen
easy pouring



Messbecher „STACKABLE“

measuring cup
jarra graduada
pichet gradué



mit offenem Griff und geprägter Maßskalierung außen, platzsparend stapelbar
with open handle and embossed dimension scaling on the outside, space-saving stackable
con asa abierta y escala de dimensiones en relieve en el exterior, apilable para ahorrar espacio
avec une poignée ouverte et une échelle de dimensions en relief à l'extérieur, empilable et peu encombrante

	Ø cm	↑ cm	ltr.
30059	7	12	0,25
30061	9	14	0,5
30062	12	16,5	1,0
30063	15	20,5	2,0



offener Griff
open handle



einfaches Eingießen
easy pouring



stapelbar
stackable



30072 1 ltr.



30058 1 ltr.

inkl. Spritzschutz / incl. splash guard

Rührbecher mit Deckel
 stirring cup with lid
 vaso agitador con tapa
 tasse à remuer avec couvercle



inklusive Spritzschutz und geprägter Maßskalierung außen, platzsparend stapelbar
 included splash guard with open handle and embossed dimension scaling on the outside, space-saving stackable
 protección contra salpicaduras incluida con asa abierta y escala de dimensiones en relieve en el exterior, apilable para ahorrar espacio
 protection contre les éclaboussures incluse avec une poignée ouverte et une échelle de dimensions en relief à l'extérieur, empilable et peu encombrante

	Ø cm	↑ cm	ltr.	Farbe / Colour
30072 <small>NEW</small>	12,5	16	1,0	
30058	12,5	16	1,0	



Griff mit Daumenmulde
 handle with thumb recess



mit Silikonring
 with silicone ring



inklusive Spritzschutz
 incl. splash guard



1 ltr.



Messbecher
 graduated jug
 jarra graduada
 pichet gradué

außen hochglanzpoliert, innen matt poliert, mit Maßskalierung außen
 outside mirror polished, inside matt polished, with stamped liter scale
 exterior pulido brillante, interior pulido mate con escalado en litros
 extérieur poli brillant, intérieur poli mat, graduation en litres

	Ø cm	↑ cm	ltr.
30045	10	14	1



30075 10,5 ltr.



30078 17 ltr.

Profi-Eimer
 bucket
 cubo
 seau



mit Ausgießer und geprägter Maßskalierung innen
 with spout and embossed dimension scaling inside
 con pico y escala de medición en relieve en el interior
 avec bec verseur et échelle de mesure en relief à l'intérieur

	Ø cm	↑ cm	ltr.	Farbe / Colour
30075	28,5	28,5	10,5	
30076	33,0	32,0	17,0	
30077	28,5	28,5	10,5	
30078	33,0	32,0	17,0	



mit Griff
 with handle



Maßskalierung innen
 dimension scaling inside



Auslaufnase für sicheres Handling
 discharge nose for safe handling

CAKE SETTING RINGS



Backform

baking pan
marco pastelero
forme à gateaux

stufenlos verstellbar, aus flexiblem Edelstahl

adjustable, made of flexible stainless steel

ajustable, de acero inoxidable flexible

ajustable, en acier inox flexible



	cm	↑ cm
00042	19 x 28 - 34 x 54	5



Anwendungsbeispiel
application example



Tortenring

cake setting ring
aro de tarta
cercle à gâteaux

stufenlos verstellbar, ohne Griff

adjustable, without handle

ajustables, sin asa

ajustables, sans poignée



	Ø cm	↑ cm
00040	16,5 - 32	7



Anwendungsbeispiel
application example



Schaumspesering

mousse ring
aro redondo para semifríos
cercle à mousse rond

matt poliert, fugenlos

matt polished, seamless

pulido mate, sin soldadura

poli mat, sans soudure



	Ø cm	↑ cm
00098	6	4,5
00099	7	4,5
00092	8	4,5
00093	10	4,5
00094	12	4,5



Schaumspeseringe, 5er Set

mousse ring, 5 pcs.

juego aros para emplatar o para semifríos
jeu de cercles à mousse inox, ronds

5-teilig: 4 Formen + 1 Verdichter, matt poliert, fugenlos

5 pcs. set: 4 shapes and 1 pusher, matt polished, seamless

juego de 5 piezas: 4 aros redondos y 1 pulsador, para dar forma, satinado sin soldadura

jeu de 5 pièces: 4 cercles et 1 poussoir. Idéal pour dressage sur assiette ou mousse, poli mat, sans soudure



	Ø cm	↑ cm	pcs.
00110	6	4,5	5
00113	8	4,5	5



Dariolformen, 2er Set

dariol moulds, 2 pcs.
juego 2 flaneras
jeu de 2 moules à flan



hochglanzpoliert
mirror polished
pulido brillante
poli brillant

	Ø cm	↑ cm	ltr.	pcs.
00106	6,5	4,5	0,1	2



Ausstellblech / Thekenblech

display tray
bandeja pastelera
plaque pâtissière



hitzebeständig bis 230°C
heat-resistant up to 230°C
resistente al calor hasta 230 °C
résistant à la chaleur jusqu'à 230°C

	cm	↑ cm
13377	40 x 25	2
13378	48 x 32	2
13379	60 x 40	2



Teigspatel / Stielschaber
dough spatula / handle scraper
espátula masa / rascador
spatule à pâte / raclette



Aufhängeloch
with hanging hole
con agujero para colgar
avec trou de suspension

	→ cm	Farbe / Colour
88950	25,5	—
88951	35,5	—



Trichter „PROFI“
 funnel
 embudo
 entonnoir
 mit Öse
 with eyelet
 con ojal
 avec œillet



	Ø cm	Ø mm Durchlass	
30065	6	8	
30066	8	11	
30067	10	12	
30068	12	12	
30069	14	15	
30070	17	17	mit Sieb / with strainer
30071	21	20	mit Sieb / with strainer



erleichtert das Einfüllen
 facilitates filling



Anwendungsmöglichkeit
 applicability



mit einsetzbarem Sieb
 with insertable strainer



mit einsetzbarem Sieb
 with insertable strainer



Mehlschaufel „PRO“

scoop
pala
pelle à farine

stehende Schaufel, auch für Flüssigkeiten geeignet

standing scoop, also applicable for liquids

pala, ápto también para líquidos

adaptée pour poudres et liquides



	cm	↑ cm	ltr.	Farbe / Colour
00610	25 x 9	4,5	0,25	White
00611	31 x 12	5,5	0,5	White
00612	35 x 13	6	0,7	White



Schaufel „ECO“

scoop
pala
pelle

stabil und bruchsicher

stable and unbreakable

estable e irrompible

stable et incassable



	→ cm	ltr.
00694	18	0,110
00695	24	0,230
00696	31	0,470
00697	33	0,725



Zum schnellen und zielgerichteten Abfüllen von Lebensmitteln

for fast and targeted filling of foodstuffs

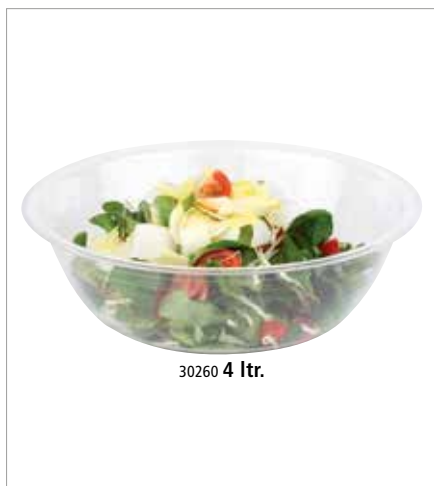

Schüssel

bowl
ensaladera
saladier

glasklar

crystal clear

cristalina

transparent

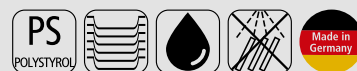

	Ø cm	↑ cm	ltr.	Farbe / Colour
30260	32,5	10	4	White
30263	40	12	8	White



SQUEEZE BOTTLES



Quetschflasche

squeeze bottle
bote dosificador flexible
bouteille verseuse souple



mit Schraubdeckel und Verschlusskappe, ideal für Dressing und Saucen

with tight-screw and cap, ideal for dressing and sauce

con tapa de rosca y tapón, ideal para aliño y salsas

avec couvercle à visser et bouchon de fermeture, idéal pour vinaigrette et sauces

	Ø cm	↑ cm	ltr.	Farbe / Colour
93259	8	26,5	1,025	White
93260	8	26,5	1,025	Yellow
93261	8	26,5	1,025	Red



große Öffnung
big mouth opening



Quetschflasche

squeeze bottle
bote dosificador flexible
bouteille verseuse souple



mit Schraubdeckel und Verschlusskappe, ideal für Dressing und Saucen

with tight-screw and cap, ideal for dressing and sauce

con tapa de rosca y tapón, ideal para aliño y salsas

avec couvercle à visser et bouchon de fermeture, idéal pour vinaigrette et sauces

	Ø cm	↑ cm	ltr.	Farbe / Colour
93155	6,5	24	0,65	Yellow
93156	6,5	24	0,65	Red
93157	6,5	24	0,65	White



Quetschflasche „MINI“, 4er Set

squeeze bottle, 4 pcs.
bote dosificador flexible, 4 pz.
bouteille verseuse souple, 4 pc.



mit Schraubdeckel und Verschlusskappe, ideal für Dressing und Saucen

with tight-screw and cap, ideal for dressing and sauce

con tapa de rosca y tapón, ideal para aliño y salsas

avec couvercle à visser et bouchon de fermeture, idéal pour vinaigrette et sauces

	Ø cm	↑ cm	ltr.	pcs.
93225	3,0	8,5	0,03	4
93226	3,5	9,5	0,05	4



93253 0,49 ltr.

93251 0,26 ltr.

93258 0,76 ltr.

Quetschflasche, 6er Set

squeeze bottle, 6 pcs.
bote dosificador flexible, set de 6
bouteille verseuse souple, set de 6



mit Schraubdeckel und Verschlusskappe, ideal für Dressing und Saucen

with tight-screw and cap, ideal for dressing and sauce
con tapa de rosca y tapón, ideal para aliño y salsas
avec couvercle à visser et bouchon de fermeture, idéal pour vinaigrette et sauces

	Ø cm	↑ cm	ltr.	Farbe / Colour	pcs.
93250	5	18,0	0,26		6
93251	5	18,0	0,26		6
93252	5	18,0	0,26		6
93253	7	20,0	0,49		6
93254	7	20,0	0,49		6
93255	7	20,0	0,49		6
93256	7	26,5	0,76		6
93257	7	26,5	0,76		6
93258	7	26,5	0,76		6



mit Verschlusskappe
with cap



große „Öffnung“
big „mouth opening“



93270 0,35 ltr.

93271 0,35 ltr.

93272 0,35 ltr.

93273 0,75 ltr.

93274 0,75 ltr.

93275 0,75 ltr.

Quetschflasche „NON DRIP“

squeeze bottle
bote dosificador flexible
bouteille verseuse souple



mit Schraubdeckel, ideal für Dressing und Saucen

with tight-screw, ideal for dressing and sauce
con tapa de rosca, ideal para aliño y salsas
avec couvercle à visser, idéal pour vinaigrette et sauces

	Ø cm	↑ cm	ltr.	Farbe / Colour
93270	5,5	21,0	0,35	
93271	5,5	21,0	0,35	
93272	5,5	21,0	0,35	
93273	7,0	25,5	0,75	
93274	7,0	25,5	0,75	
93275	7,0	25,5	0,75	



mit Skalierung
with scalling



tropffrei
non drip



93154

Quetschflasche

squeeze bottle
bote dosificador flexible
bouteille verseuse souple



ideale Größe, um Speiseteller mit Saucen zu verzieren, mit Verschlusskappe

ideal size to garnish plates with sauces, with cap
tamaño ideal para decorar platos con salsas, con tapón
taille idéale pour décorer assiettes avec des sauces, avec bouchon

	Ø cm	↑ cm	ltr.
93154	5	16	0,2
93163	6	21	0,35



Dosierspender
dispenser
dispensador de salsa
doseur à sauce



	cm	↑ cm	ltr.	GN
93280	17,6 x 16,2	27	2,6	1/6

Dosierpumpe, Hubvolumen 30 ml
dosing pump / riser tube, swept volume 30 ml
bomba de salsa, sola, cada dosis 30 ml
pompe à sauce, 30 ml par dose



	cm	↑ cm	ltr.	
93281	12,5 x 4,5	26	0,30	fits to 93280



Dosierpumpe
dosing pump / riser tube
bomba de salsa, sola
pompe à sauce



Hubvolumen 30 ml / swept volume 30 ml / cada dosis 30 ml / 30 ml par dose

	Ø cm	↑ cm
88271	4,5	40



Eier-Box
eggs box
caja para huevos
boîte à oeufs



mit luftdichtem Deckel, für 4 Lagen à 30 Eier, Lieferung inkl. 8 Lagen, Größe Lage: 28 x 28 cm
with airtight cover, capacity: 4 trays of 30 eggs, delivery with 8 trays, size of tray: 28 x 28 cm
capacidad para 4 bandejas de 30 huevos, tapa hermética, se entrega con 8 bandejas, formato bandejas 28 x 28 cm, apto para lavavajillas
pour 4 plateaux de 30 oeufs chacun, apte pour 4 plateaux plats, couvercle hermétique, livré avec 8 plateaux, dimension plateau 28x28 cm, lavable en lave-vaisselle

	cm	↑ cm	GN
82419	35,4 x 32,5	20	2/3

10 Lagen / 10 trays / 10 bandejas / 10 plateaux

82420



Aufsteller „ACHTUNG RUTSCHGEFAHR“

stand
letrero
panneau



	cm	↑ cm
71421	30 x 63	63



Limetten- / Zitronenpresse

lime- / lemonpress
 exprimidor de limón / lima
 presse citron

2 Pressringe für Zitrone und Limette
 2 squeezing rings for lemon and lime
 2 anillos exprimidores para limón y lima
 2 anneaux à presser pour le citron et le lime



	cm	↑ cm	
93214	21 x 7	5	



Limettenpresse

lime press
 prensa de limón
 presse citron



	cm	↑ cm	
93189	21 x 7	5	



Zitruspresse

citrus squeezer
 exprimidor cítricos
 presse-citron

hochglanzpoliert, 2-teilig
 mirror polished, 2 pcs.
 pulido brillante, 2 piezas
 poli brillant, 2 pièces



	Ø cm	↑ cm	ltr.
71431	12 / 17	10,5	0,35

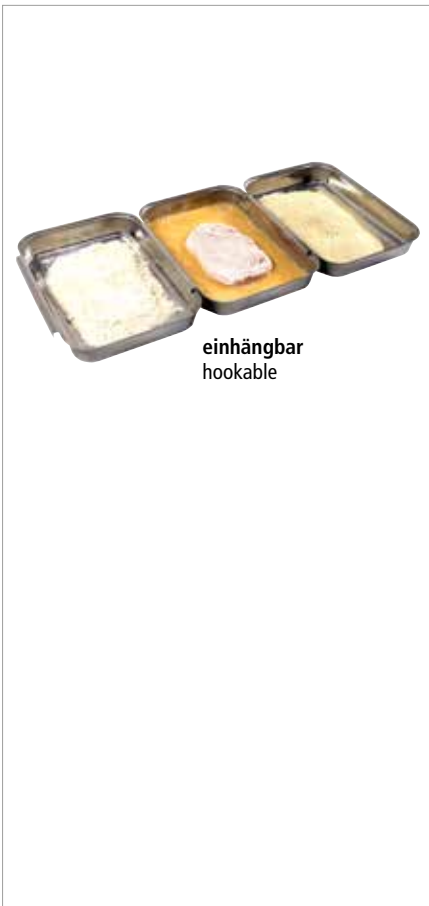

Panierstation, 3-teilig

breeding set, 3 pcs. set
 estación de empanado, set de 3
 station de panure, set de 3

zum Panieren von Fleisch, Gemüse, Käse etc.
 for breading meat, vegetables, cheese etc.
 para empanar carne, verduras, queso, etc.
 pour paner la viande, les légumes, le fromage etc.



	cm	↑ cm	
66904	45,5 x 18	2,5	



PIZZA PANS



9 sizes



Pizzaform
pizza pan
molde de pizza
moule à pizza



Blaublech, nicht beschichtet, lange Lebensdauer, hitzebeständig bis 360 °C
blue steel, without coating, long endurance, heat resistant up to 360 °C
chapa azul, sin revestimiento, larga vida útil, resistente al calor hasta 360 °C
métal, sans revêtement, longue durée de vie, à la chaleur jusqu'à 360 °C

	∅ cm	↑ cm
73502	16 - 18	2,5
73505	22 - 24	2,5
73506	24 - 26	2,5
73507	26 - 28	2,5
73508	28 - 30	2,5
73509	30 - 32	2,5
73510	34 - 36	2,5
73511	38 - 40	2,5
73513	48 - 50	3,0



stapelbar
stackable



Pizzaform
pizza pan
molde de pizza
moule à pizza



Blaublech, rechteckig, Rand umgelegt, hitzebeständig bis 360 °C
blue steel baking sheet, rectangular, heat resistant up to 360 °C
chapa azul rectangular, borde plgado, resistente al calor hasta 360 °C
métal, rectangulaire, bord plié, à la chaleur jusqu'à 360 °C

	cm	↑ cm
88256	60 x 40	2,5



Gestell für Pizzaformen

rack for pizza pans
rejilla para pizzas
support pour moules à pizza



Edelstahlgestell zusammenklappbar für Pizzaformen Ø 28 cm, Abstand zwischen den Ebenen 5,5 cm

foldable stainless steel rack for pizza dishes ø 28 cm, distance between the levels 5.5 cm
rejilla plegable de acero inoxidable para moldes de pizza de Ø 28 cm, distancia entre los niveles 5,5 cm
support en acier inox pliable pour les moules à pizza de Ø 28 cm, distance entre les niveaux 5,5 cm

	cm	↑ cm
73515	26 x 25	26



Backofen geeignet
suitable for oven

Pizzaform für Ø 28 cm
pizza dish for Ø 28 cm

Pizzaform
pizza pan
molde de pizza
moule à pizza



	Ø cm	↑ cm	mm
73507	26 / 28	2,5	1



Pizzaschaufel

pizza peel
pala de pizza
pelle à pizza



	cm	→ cm
88080	35 x 30,5	90
88081	35 x 30,5	130



Pizzaschneider „TOOLTIME“

pizza cutter
cortador de pizza
coupe-pizza

ergonomischer Griff
ergonomic handle
mango ergonómico
manche ergonomique



	Ø cm	→ cm
88949	10	20



Korkuntersetzer

cork mat
salvamanteles
dessous-de-plat liège

ideal für Servier- und Eisenpfannen
ideal for iron pan
ideal para servir en sartenes de chapa
idéal pour présenter les poêles forgées sur table



	Ø cm	↑ cm
73750	24	2



Backhandschuhe

baking mittens
manoplas de panadero
gants de boulanger

Leder, gefüttert, Einheitsgröße, mit Stulpen, extrem hitzebeständig bis 250°C
leather, inner lining, one size, with cuffs, extremely heat resistant up to 250°C
cuero interior forrado, talla única, resiste a temperaturas hasta 250°C
cuir intérieur doublé, taille unique, résiste à maxi 250°C

	→ cm
88090	45



Teig- und Pizzaballenbehälter

dough and pizza ball container
recipiente para masa y bolas de pizza
récipient à pâte et boules à pizza

Innenmaß 56,5 x 36,5 cm, H: 6,5 cm
inner dimension 56,5 x 36,5 cm, H: 6,5 cm
medida interior 56,5 x 36,5 cm, H: 6,5 cm
dimension intérieure 56,5 x 36,5 cm, H: 6,5 cm



	cm	↑ cm	ltr.
82440	60 x 40	7	13



stapelbar
stackable

passender Deckel / fitting lid / tapa adecuada / couvercle approprié

	cm	↑ cm
82441	60 x 40	1



Feinkost- / Olivenlöffel, 6er Set
 delicatessen / olives spoon, 6 pcs.
 cuchara gourmet / para aceitunas, set de 6
 cuillère gourmet / à olives, set de 6



gelocht
 perforated
 perforadas
 perforées

	cm	→ cm	pcs.	Farbe / Colour
88598	6 x 9	27	6	■



Feinkostlöffel, 6er Set
 delicatessen spoon, 6 pcs.
 cuchara gourmet, set de 6
 cuillère gourmet, set de 6



aus Kunststoff
 plastic
 plástico
 plastique

	Ø cm	→ cm	pcs.	Farbe / Colour
88627	6	23	6	■
88628	6	23	6	■



Dressinglöffel
 dressing spoon
 cuchara de aliño
 cuillère à sauce



aus Kunststoff
 plastic
 plástico
 plastique

	Ø cm	→ cm	ltr.	Farbe / Colour
88636	6	34	0,05	■
88609	6	34	0,05	■



Salatbesteck „OLIVE“, 2er Set

spoon, 2 pcs.
cuchara, set de 2
cuillère, set de 2

aus Olivenholz

olive wood
madera de olivo
en bois d'olivier



	cm	→ cm
00841	9,5 x 8,5	17,0
00842	7,5 x 6,0	22,5



Anwendungsbeispiel
application example



Anwendungsbeispiel
application example



Löffel „OLIVE“

spoon
cuchara
cuillère

aus Olivenholz, ideal für Reis, Gemüse...

olive wood, ideal for rice, vegetables...
madera de olivo, ideal para arroz, verduras...
en bois d'olivier, idéal pour le riz, les légumes...



	cm	→ cm
00840	9,5 x 8,5	17,0



Schaufel „OLIVE“

scoop
pala
pelle

aus Olivenholz, ideal für Gewürze, Körner etc.

olive wood, ideal for spices, grains etc.
madera de olivo, ideal para especias, granos etc.
en bois d'olivier, idéal pour les épices, céréales, etc.



	→ cm
01020	13,5





Löffel „OLIVE“, 2er Set

spoon, 2 pcs.
cuchara, set de 2
cuillère, set de 2

aus Olivenholz, ideal für Gewürze
olive wood, ideal for spices
madera de olivo, ideal para especias
en bois d'olivier, idéal pour les épices



	→ cm	pcs.
01018	14	2



Honiglöffel „OLIVE“

honey spoon
cuchara de miel
cuillère à miel

aus Olivenholz
olive wood
madera de olivo
en bois d'olivier



	→ cm
01019	15



Löffel „ACACIA“

spoon
cuchara
cuillère

aus Akazienholz, ideal für Reis, Gemüse...
acacia wood, ideal for rice, vegetables...
madera de acacia, ideal para arroz, verduras...
bois d'acacia, idéal pour le riz, les légumes...



	cm	→ cm
00599	9 x 6,5	23,5

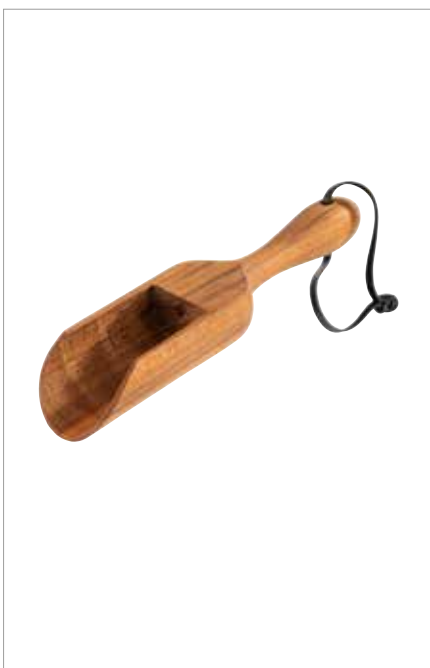

Schaufel

scoop
pala
pelle

aus geöltem Eichenholz, mit Kunstlederband, ideal für Gewürze, Körner etc.
made of oiled oak wood, with leatherette strap, ideal for spices, grains etc.
de madera de roble aceitada, con correa de polipiel, ideal para especias, granos etc.
en bois de chêne huilé, avec bracelet en simili-cuir, idéal pour les épices, céréales, etc.



	cm	↑ cm
01026	25,5 x 6	4,5



Anwendungsbeispiel
application example



Bonspieß

bill spike
pinchanotas
pique-bons



Spieße aus flexiblem Kunststoff, mit stumpfen Enden zur Unfallverhütung

spikes made of flexible plastic, with blunt ends to prevent accidents
pinchos de plástico flexible
piques en plastique flexible

	cm	↑ cm
88855	9 x 5,5	10,5



Bonleiste

bill rail
portafichas
barre porte-bons



matt poliert, mit Kugel-Greifsystem, zur Wandmontage geeignet, auch mit Magneten nutzbar
matt polished, small balls hold the bills, suited for wall fastening, can also be used with magnets

pulido mate, con sistema de bolas para colgar las notas para fijar en la pared, puede usarse con imán

poli mat, avec billes pour fixer sans effort tous types de fiches et papiers, peut se fixer sur plaque aimantée

	cm	↑ cm
88900	40 x 8	2
88901	50 x 8	2
88902	60 x 8	2



Magnet-Messerhalter

magnetic knife rack
barra magnética para cuchillos
barre aimantée pour couteaux



mit 2 Magnetschienen und Haken, aus massivem Kunststoff, zur Wandmontage geeignet, Lieferung ohne Deko

with 2 magnet racks and hooks, strong plastic, suited for wall fastening

con 2 rails magnéticos y ganchos, plástico macizo, fijación en pared
avec 2 rails aimantés et crochets, plastique robuste, fixation murale

	→ cm
88911	45
88912	60



Folien-Abreißvorrichtung

clingfilm tear-off-dispenser
dispensador de film
dérouleur de film



mit Abreißkante / Säge-Messer, für Endlosfolie, als Tischgerät oder Wandgerät verwendbar
with saw, for endless rolls, can be fixed on the wall

con sierra para rollo de film continuo, se puede fijar en la pared
avec lame dentée pour rouleau de film, peut être fixé au mur

	cm	↑ cm	
88288	34 x 16	9	für Folienbreite 30 cm / for film width 30 cm para film ancho 30 cm / pour film largeur 30 cm
88287	49 x 16	9	für Folienbreite 45 cm / for film width 45 cm para film ancho 45 cm / pour film largeur 45 cm



Schneidbrettständer

cutting board rack
soporte para tablas
rack pour planches à découper

für 6 Schneidbretter bis 25 mm Stärke, Lieferung ohne Deko

for 6 chopping boards up to 25 mm thickness
para 6 tablas de corte de 25 mm
pour 6 planches de 25 mm



	cm	↑ cm
88903	27 x 31	28



Eiswaffel-Ständer

cornet stand
soporte cucuruchos
support à cornets

matt poliert, mit 4 Löchern, 2 x Ø 31 mm + 2 x Ø 26 mm

matt polished, with 4 holes, 2 x Ø 31 mm + 2 x Ø 26 mm
pulido mate, con 4 agujeros 2 x Ø 31 mm + 2 x Ø 26 mm
poli mat, 4 trous - 2 x Ø 31 mm + 2 x Ø 26 mm



	cm	↑ cm
11881	27,5 x 9,5	9



Eisportionierer

ice cream scoop
cuchara para helado
cuillère à glace

hochglanzpoliert, mit Edelstahlfeder (physikalisch bedingt nicht korrosionsbeständig)

mirror polished, spring steel, spring is not stainless
pulido brillante, muelle de acero especial, no resistente al óxido
poli brillant, ressort acier spécial, non résistant à l'oxydation



	Ø cm	→ cm	ltr.
71006	6,5	23,5	1/12
71005	6,0	22,5	1/16
71004	5,5	22,0	1/20
71003	5,0	22,0	1/24
71002	5,0	21,5	1/30
71001	4,5	21,0	1/36

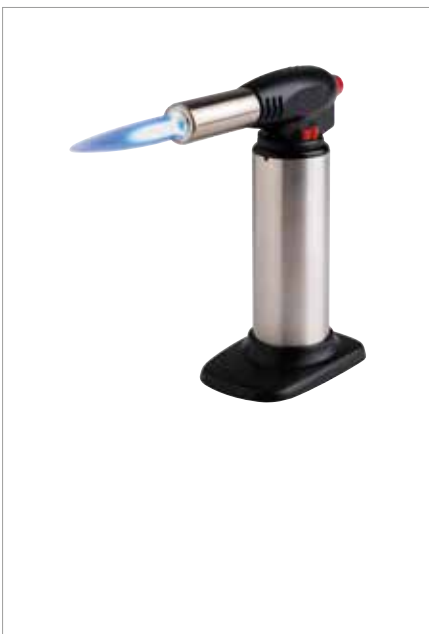

Flambierbrenner

chefs blow torch
soplete de cocina para flambear
chalumeau de cuisine

mit handelsüblichem Feuerzeuggas auffüllbar, Flamme einstellbar bis ca. 1300° C, Brenndauer von mindestens 60 Minuten

to be filled with commercial lighter gas, flame adjustable up to approx. 1300° C, burning time of at least 60 minutes
rellenable con gas de mechero comercial, llama ajustable hasta 1300° C, tiempo de combustión de al menos 60 minutos
rempli avec gaz pour briquet commercial, flamme réglable jusqu'à 1300° C, temps de combustion d'au moins 60 minutes



	Ø cm	↑ cm
77315	4,5	16,5



Anwendungsbeispiel
application example





Covers & Accessories

GN COVERS	562
GN ROLLTOP COVERS	565
ROLLTOP COVERS	566
PLATE COVERS	567
SUPER DOME	568
COVERS	570
LIDS	572
COOLERS	575



GN Kuppelhaube

GN cover
GN cúpula
GN cloche bombée

glasklarer Kunststoff, Griff aus Zinkdruckguss

crystal clear plastic, die-cast zinc knob

plástico transparente, asa de zinc fundido a presión

plastique transparente, poignée en zinc moulé sous pression



	cm	↑ cm	GN	
11021	33 x 28	17	1/2	geschlossen / totally closed cerrada / totement fermée
11022	33 x 28	17	1/2	mit Front-Ausschnitt / one long side cut out gran apertura frontal grande ouverture frontale
11026	54 x 33	20	1/1	geschlossen / totally closed cerrada / totement fermée
11027	54 x 33	20	1/1	mit Front-Ausschnitt / one long side cut out gran apertura frontal grande ouverture frontale
11028	54 x 33	20	1/1	mit seitlichem Ausschnitt one small side cut out pequeña apertura lateral petite ouverture latérale



**GN Kuppelhaube**

GN cover
GN cúpula
GN cloche bombée

**glasklarer Kunststoff, Griff aus Zinkdruckguss**

crystal clear plastic, die-cast zinc knob

plástico transparente, asa de zinc fundido a presión

plastique transparente, poignée en zinc moulé sous pression

	cm	↑ cm	GN	
11070	54 x 33	20	1/1	geschlossen / totally closed cerrada / totalmente fermée
11071	54 x 33	20	1/1	mit Front-Ausschnitt / one long side cut out gran apertura frontal grande ouverture frontale
11072	54 x 33	20	1/1	mit seitlichem Ausschnitt one small side cut out pequeña apertura lateral petite ouverture latérale
11073	33 x 28	17	1/2	geschlossen / totally closed cerrada / totalmente fermée
11074	33 x 28	17	1/2	mit Front-Ausschnitt / one long side cut out gran apertura frontal grande ouverture frontale

**GN 1/1 Haube**

GN 1/1 cover
GN 1/1 campana
GN 1/1 cloche

**klappbar, passend für GN 1/1-Behälter, GN 1/1-Tablets, etc., nahezu bruchfest**

suitable for GN 1/1 chafing dish, GN 1/1 trays, GN 1/1 pans

plegable, para cubetas GN 1/1, bandejas GN 1/1 etc., muy resistente a la rotura

pliable, pour bacs GN 1/1, plateaux GN 1/1 etc., très résistant à la casse

	cm	↑ cm	GN
11013	53,0 x 32,5	6	1/1



klappbar
adjustable

QUALITÄTSHAUBEN

11042
GN 1/1

11041
GN 1/2



11043 GN 1/3



11044 GN 2/4



11041 GN 1/2



11042 GN 1/1

GN Abdeckhaube

GN cover
GN cubierta
GN cloche



passend für GN Tablett, glasklarer Kunststoff, nahezu bruchfest

suitable for GN trays, clear plastic, nearly unbreakable

apto para bandejas GN, plástico transparente, muy resistente a la rotura

pour bacs et plateaux GN, plastique transparent, très résistant à la casse

	cm	↑ cm	* mm	GN
11043	32,5 x 17,6	10,5	3	1/3
11044	53,0 x 16,2	10,5	3	2/4

	cm	↑ cm	* mm	GN
11041	32,5 x 26,5	9,5	3	1/2
11042	53,0 x 32,5	9,5	3	1/1



stapelbar
stackable



GN 1/1 Haube „HOCHSTAPLER“

GN 1/1 cover
GN 1/1 campana
GN 1/1 cloche



glasklarer Kunststoff, Tablett fixiert sich auf der Haube - kein Rutschen möglich, nahezu bruchfest

clear plastic, tray fixes itself on the cover and can not slip off, nearly unbreakable

plástico transparente, la bandeja se fija a la tapa para que no se deslice, muy resistente a la rotura

en plastique transparent, le plat se fixe sur le dessous de la cloche pour ne pas glisser, très résistant à la casse

	cm	↑ cm	GN	fits to
11305	53 x 32,5	9	1/1	11295, 11300



GN 1/1 Rolltophaube

GN 1/1 rolltop cover
GN 1/1 campana rolltop
GN 1/1 cloche rolltop



patentiert, passend für GN-Behälter, -Tablets, etc., leichtgängig auf- und zuklappbar 90°
patented, suitable for GN trays, solid quality, 90° opening
patentada, para cubetas GN, bandejas GN, etc. fácil de abrir y cerrar 90°
brevetée, pour bacs GN, plateaux GN, etc. s'ouvre et se ferme facilement à 90°

	cm	↑ cm	GN
11075	53,0 x 32,5	19	1/1



GN Rolltophaube

GN rolltop cover
GN campana rolltop
GN cloche rolltop



patentiert, passend für GN-Behälter, -Tablets, etc., leichtgängig auf- und zuklappbar 90°
patented, suitable for GN trays, solid quality, 90° opening
patentada, para bandejas GN, apertura 90°
brevetée, pour plateaux GN, ouverture 90°

	cm	↑ cm	GN	
11008	53,0 x 32,5	19	1/1	vergoldeter Griff / gold plated handle pomo dorado / bouton doré
11010	53,0 x 32,5	19	1/1	verchromter Griff / chrome plated handle pomo cromado / bouton chromé
12008	32,5 x 26,5	15	1/2	vergoldeter Griff / gold plated handle pomo dorado / bouton doré
12010	32,5 x 26,5	15	1/2	verchromter Griff / chrome plated handle pomo cromado / bouton chromé



GN 1/1

GN 1/1 Rolltophaube „SUNDAY“

GN 1/1 rolltop cover
GN 1/1 campana rolltop
GN 1/1 cloche rolltop



Griff ABS verchromt, leichtgängig auf- und zuklappbar
handle chrome plated, easy to open and close
asa material ABS cromado, fácil de abrir y cerrar
poignée matériel ABS chrome, ouverture et fermeture faciles

	cm	↑ cm	GN
11016	53,0 x 32,5	19	1/1



GN 1/1

GN 1/1 Rolltophaube

GN 1/1 rolltop cover
GN 1/1 campana abatible
GN 1/1 cloche basculante



verchromter Zinkdruckguss-Griff / chrome plated metal handle / mango cromado de fundición a presión de zinc / poignée en zinc moulé sous pression chromé

	cm	↑ cm	GN
11018	53,0 x 32,5	19	1/1



Rolltophaube „FOCUS“

rolltop cover
campana abatible
cloche basculante



verchromter Griff / chrome plated handle / pomo cromado / bouton chromé

	cm	↑ cm
09013	44 x 33,5	17

ROLLTOP COVERS

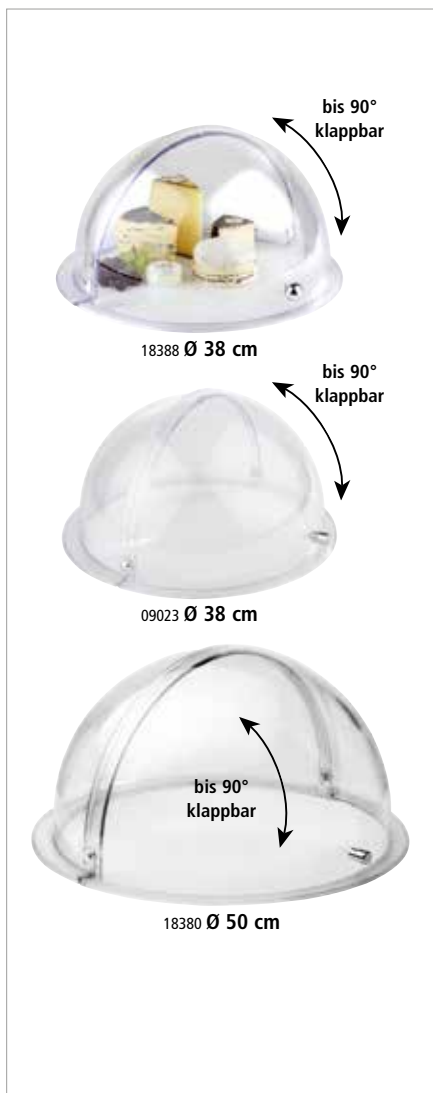

Rolltophaube

rolltop cover
campana abatible
cloche basculante

glasklarer Kunststoff, leichtgängig auf- und zuklappen 90°

solid quality, to be opened 90°

plástico transparente, apertura 90°

plastique transparent résistant, ouverture 90°



	Ø cm	↑ cm	
18388	38	20	mit verchromtem Kugelgriff / with chrome plated handle con pomo cromado / avec bouton chromé
18387	38	20	mit vergoldetem Kugelgriff / gold plated handle pomo dorado / bouton doré
09023	38	20	mit verchromtem Zylindergriff / chrome plated handle pomo cromado / bouton chromé
18380	50	26	mit verchromtem Zylindergriff / chrome plated handle pomo cromado / bouton chromé



Frischhaltehaube

cover
campana
cloche bombée

glasklar, Griff aus 18/10 Edelstahl, schwere, stabile Ausführung

transparent, handle made of 18/10 stainless steel, heavy stable quality

transparente, mango de acero inoxidable 18/10, alta estabilidad

transparente, manche en acier inoxydable 18/10, anse chromée, très stable



	Ø cm	↑ cm
15350	16,5	10
15351	20,5	10



Frischhaltehaube

cover
campana
cloche



	Ø cm	↑ cm	fits to
11055	23	12	00825, 00827, 00848, 30148, 30334



Set 00827

glasklar, schwere stabile Ausführung
clear, heavy stable quality



Frischhaltehaube

cover
campana
cloche



	cm	↑ cm	fits to
11056	25 x 12	10	00826, 00828, 00849, 30149, 30338, 85099



Set 00828

glasklar, schwere stabile Ausführung
clear, heavy stable quality



Frischhaltehaube

cover
campana
cloche



	cm	↑ cm
06401	29,5 x 13,5	10
06701	21,6 x 16,2	7



Lieferung ohne Tablett | delivery without tray

Frischhaltehaube

cover
campana
cloche



	cm	↑ cm
18621	Ø 18	8,5
18121	35,5 x 27,8	7,5

SUPER DOME





06525 Ø 30 cm

85052

Frischhaltehaube „SUPER DOME“

cover
campana
cloche



schwere, glasklare Qualität
stable, crystal clear quality
muy resistente y transparencia cristalina
haute résistance et transparence

	Ø cm	↑ cm
06525	30	40

passende Servier- Tortenplatten / suitable cake stands / porta pasteles compatibles /
présentoirs à gâteaux compatibles

	Ø cm	↑ cm	fits to	Farbe / Colour
00468	31,0	3,5	06525	
33294	33,0	8,0	06525	
33295	33,0	16,0	06525	

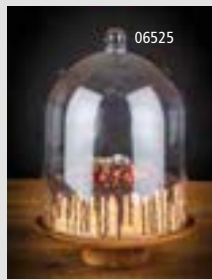

06525

Servierbeispiel
presentation example



06525

Präsentationsmöglichkeiten
presentation examples



06525

85052

85051

00468



06519

Ø 21cm

06520

Ø 30cm

3 sizes available Ø 21/ 30 / 36 cm

Frischhaltehaube

cover
campana
cloche



schwere, glasklare Qualität
stable, crystal clear quality
calidad estable y transparencia cristalina
qualité stable et clarté cristalline

	Ø cm	↑ cm	fits to
06519	21	17	33292, 33293
06520	30	22	00046, 00463, 00468, 00469, 00975, 00998, 15621, 15622, 33294, 33295, 83884, 83890, 83891, 84177, 84943, 84944
06521	36	27	00816, 33296, 33297



stapelbar
stackable

Präsentationsmöglichkeiten
presentation examples

COVERS



06512

Frischhaltehaube

cover
campana
cloche

glasklar, schwere stabile Ausführung, stapelbar

clear, heavy stable quality, stackable

transparente, alta estabilidad, apilable

transparente, très stable, empilable



	Ø cm	↑ cm	
06512	30	11,5	mit verchromtem Griff / with chrom plated handle con botón cromado / avec bouton chromé
06517	30	12,5	mit verchromtem Griff / with chrom plated handle con botón cromado / avec bouton chromé



06515

Frischhaltehaube

cover
campana
cloche

glasklar, schwere stabile Ausführung, stapelbar

clear, heavy stable quality, stackable

transparente, alta estabilidad, apilable

transparente, très stable, empilable



	Ø cm	↑ cm	
06510	30	11,5	
06515	33	12,5	



stapelbar
stackable



06501

Frischhaltehaube

cover
campana
cloche



	Ø cm	↑ cm	
06501	30	11	
06504	30	9,5	
06506	30	7	



Frischhaltehauben, 2er Set

covers, 2 pcs. set
campanas, set de 2
cloches, pack de 2



	Ø cm	↑ cm	
40752	30	11	



11051 Ø 22 cm



11052 Ø 24 cm



11053 Ø 28 cm



11054 Ø 28,5 cm

Tellerabdeckhaube
plate cover
cubierta para plato
couvre-cle pour assiette

passend für unterschiedliche Tellergrößen

suitable for different plate sizes

aptas para diferentes tamaños de platos

aptes pour différentes tailles d'assiettes



	Ø cm	↑ cm	passend für Tellergrößen / suitable for plate sizes
11051	22,0	7,0	Ø 21,5 cm
11052	24,0	7,5	Ø 22,5 - 23,0 cm
11053	28,0	6,5	Ø 26,0 - 26,5 cm
11054	28,5	6,5	Ø 27,0 - 27,5 cm



33209 BLACK



33220 CHROME

Servierbeispiele
presentation example

passende Hauben
suitable covers 11051, 11052



Deckel „FRIDA“
cover
tapa
couvercle



	Ø cm	↑ cm	fits to
84962	9	2,5	84930, 84931
84963	13	2,5	84605, 84606
84964	16	2,5	84607, 84608

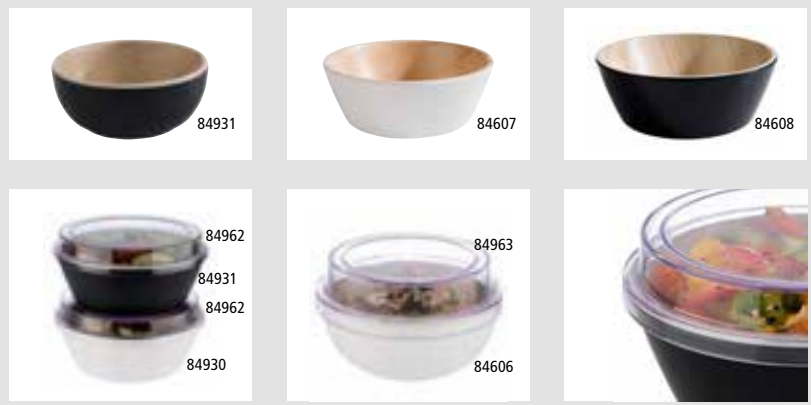

stapelbar / stackable



Deckel „FRIDA“
cover
tapa
couvercle



	cm	↑ cm	fits to
84965	13 x 13,0	2,5	84936, 84937
84966	17 x 17,0	2,5	84558, 84559
84967	18 x 16,5	2,5	84583, 84584
84968	18 x 11,0	2,5	84555, 84556

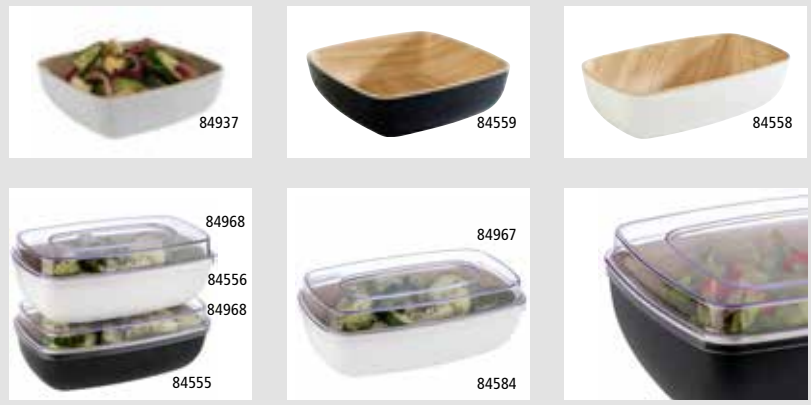

stapelbar / stackable



83921

Deckel „FLOAT“ mit Löffelaussparung

cover, with notched for spoons
tapa, con espacio para la cuchara
couvre-cle, avec encoche pour la louche



	cm	↑ cm	fits to	
83921	19 x 19	1,3	83916, 83917	eckig
83922	25 x 25	1,3	83918, 83919	eckig



83600

83601

Deckel „PURE“ mit Löffelaussparung

cover with notched for spoons
tapa con espacio para la cuchara
couvre-cle avec encoche pour la louche



	cm	↑ cm	fits to	
83600	19 x 19	1,5	79004, 79005, 83409, 83468, 84244, 85260, 85266	
83601	25 x 25	1,5	83469, 83408, 84245, 84561, 84562, 85261, 85267	



83605 Ø 8 cm

passend zu Schalen Ø 7,5 cm
fits to bowls Ø 7,5 cm

83606 Ø 14,5 cm

passend zu Schalen Ø 14 cm
fits to bowls Ø 14 cm

83607 Ø 20,5 cm

passend zu Schalen Ø 20 cm
fits to bowls Ø 20 cm

Deckel „CASUAL“, 5er Set

cover, 5 pcs. set
tapa, set de 5
couvre-cle, set de 5



Hygienischer Schutz für Ihre Speisen

- dichtschießend
- schwappsicherer Transport

protection for your food

- tightly closing
- slosh-proof transport

protección de alimentos

- con cierre hermético
- transporte sin salpicaduras

protection des aliments

- fermeture hermétique
- transport sans éclaboussures

	Ø cm	↑ cm	fits to	pcs.
83605	8,0	0,5	11866, 15400, 15416, 15461, 15462, 15467, 40655, 40656, 83881	5
83606	14,5	0,5	11865, 83700, 83701, 85104, 85105, 85107	5
83607	20,5	0,5	15404, 15420, 83704, 83705	5



83606

11865



83607

83704



stapelbar
stackable



Schutzdeckel mit Löffelaussparung

cover
tapa
couvercle



glasklar, klappbar, mit 10 Beschriftungsschildern

transparent, with 10 cards for inscription
plástico transparente, con 10 etiquetas para inscripción
plastique transparent, avec 10 étiquettes pour inscription

	Ø cm	
11868	14,5	mit verchromtem Griff / chrome plated handle botón cromado / bouton chromé
11878	23,5	mit verchromtem Griff / chrome plated handle botón cromado / bouton chromé

Schilder, 10er Set / signs, 10 pcs. set / set de 10 cartelitos / set de 10 étiquettes

	fits to
12879	11868
11879	11878



Deckel klappbar mit Löffelaussparung

cover hinged
tapa con bisagra
couvercle avec charnière



glasklar, mit Designer-Griff, verchromt, ohne Beschriftungsschild

clear, with designer handle, chrome plated, without card for inscription
transparente, con pomo de diseño cromado, sin tarjetas para inscripción
transparent, avec bouton chromé de design, sans étiquette pour inscription

	Ø cm	fits to
10889	23,5	11817, 11818, 11845, 11847, 11849



Schale

bowl
cuenco
bol



	Ø cm	↑ cm	ltr.	VE / unit
11859	6,0	2,5	0,05	36
11866	7,5	3,5	0,09	36
11865	14,0	6,5	0,50	6
11875	23,0	10,5	2,50	6



Kühlakku
cooler
acumulador de frío
accumulateur de froid



gefüllt mit Kühlflüssigkeit, nicht giftig, einfach im Gefrierfach einfrieren, unbegrenzt wiederverwendbar
freeze it in freezer, non toxic, filled with freezer-liquid, boundless reusable
se enfría en el congelador, no tóxico, se puede reutilizar sin límite
liquide eutectique qui accumule froid une fois dans le congélateur, non toxique, réutilisable sans limites

	Ø cm	↑ cm	Farbe / Colour
10777	15	2,5	White
10781	10,5	2,5	White
10661	10,5	2,0	White



Kühlakku
cooler
acumulador de frío
accumulateur de froid



	Ø cm	→ cm	Farbe / Colour
00615	7,5	11,5	Black



Kühlakku
cooler
acumulador de frío
accumulateur de froid



gefüllt mit Kühlflüssigkeit, nicht giftig, einfach im Gefrierfach einfrieren, unbegrenzt wiederverwendbar
freeze it in freezer, non toxic, filled with freezer-liquid, boundless reusable
se enfría en el congelador, no tóxico, se puede reutilizar sin límite
liquide eutectique qui accumule froid une fois dans le congélateur, non toxique, réutilisable sans limites

	cm	↑ cm	Farbe / Colour
10782	41 x 21	2,5	White
10791	25 x 19	2,5	White
11101	16 x 7,5	2,0	Blue

4er Set / 4 pieces set / set de 4 / set de 4



Aufsteller „ACHTUNG RUTSCHGEFAHR“
stand
letrero
panneau



	cm	↑ cm	Farbe / Colour
71421	30 x 63	63	Yellow

*Laser-Logo
Individual*

Laserlogo Individual

- perfekte Lasergravuren
- perfectly Laser engravings
- grabado perfecto por láser
- marçage laser parfait

≥ 10
pcs.



lasered by APS

DE

- unverwechselbar
- einzigartig
- imagefördernd

Ihre individuelle Lasergravur von APS

Wir bieten Ihnen die Möglichkeit, unsere Produkte mit Ihrem individuellen Logo per Laser zu gravieren - einzigartig, unverwechselbar und bereits ab 10 Stück je Artikel. Die perfekte Beschriftung durch modernste Lasertechnologie ist spülmaschinenfest und somit dauerhaft auf allen Edelstahl- und Naturschieferprodukten, sowie auf versilberten und verchromten Metall-Artikeln umsetzbar. Machen Sie aus Ihren Gastronom-Behältern Ihre ganz persönlichen Unikate und werten Sie Ihre Servierartikel mit Ihrem eigenen Logo auf.

- geringe Mindestbestellmenge von nur 10 Stück
- kurze Lieferzeiten
- Logos bis zu einer Fläche von max. 10 x 10 cm realisierbar

ES

- único
- personalizado
- promotor de imagen

Grabado laser por APS

Podemos grabar su logo y así personalizar los productos APS a partir de mínimo 10 unidades por referencia. Gracias a la novedosa tecnología de grabado por láser, la inscripción es perfecta y resistente al lavavajillas. Se puede aplicar a los artículos en acero inoxidable, pizarra natural, metal cromado y plateado.

- cantidad mínima de solamente 10 unidades
- realización rápida
- tamaño de logos hasta máximo 10 x 10 cm

EN

- distinct
- unique
- image enhancing

Your individualised laser engraving by APS

We offer you the option of having your personalised logo engraved on our products - inimitable, unique, and available for delivery from only 10 pieces per product. The perfect inscription by use of the newest technology is dishwasher-safe and thus can be permanently applied to products made of stainless steel and natural slate, as well as silver-coated and chromed metal articles. Turn your gastronom container into your individual, one of a kind article and enhance your serving items with your own logo.

- minimum order quantity of only 10 pieces
- swift delivery
- feasible logos are those with a maximum size of 10 x 10 cm

FR

- unique
- original
- porteur d'image

Marcage laser par APS

Nous pouvons graver votre logo et ainsi personnaliser les produits APS à partir de 10 pièces par référence. Grâce à une technologie d'avant-garde de marquage par laser, l'inscription est parfaitement reproduite et résistante au lave-vaisselle. Ce type de marquage peut s'appliquer sur l'acier inoxydable, sur l'ardoise naturelle, sur le métal chromé ou argenté.

- quantité minimum de seulement 10 unités
- fabrication rapide
- taille du logo jusque 10 x 10 cm



APS - BSCI-Mitglied

APS engagiert sich für die Verbesserung von Arbeitsbedingungen.

Wir sind Partner der europäischen Organisation BSCI. Die "Business Social Compliance Initiative" (BSCI) ist eine Initiative von Unternehmen zur Verbesserung der Arbeitsbedingungen in der globalen Versorgungskette.



APS is a member of BSCI

APS is committed to the improvement of working conditions.

We are a partner of the European organization BSCI. The "Business Social Compliance Initiative" is an initiative of enterprises to improve working conditions in the global supply chain.

APS - Garantierte Qualität

APS-Produkte entsprechen den Richtlinien der Europäischen Kommission. Diese enthalten Bestimmungen für Materialien, welche mit Lebensmitteln in Berührung kommen. Wir arbeiten sehr eng mit Zertifizierungsinstitutionen und Prüflaboren zusammen und können somit die Lebensmittelsicherheit (LFGB Regulation) der APS-Artikel garantieren.

APS - Guaranteed quality



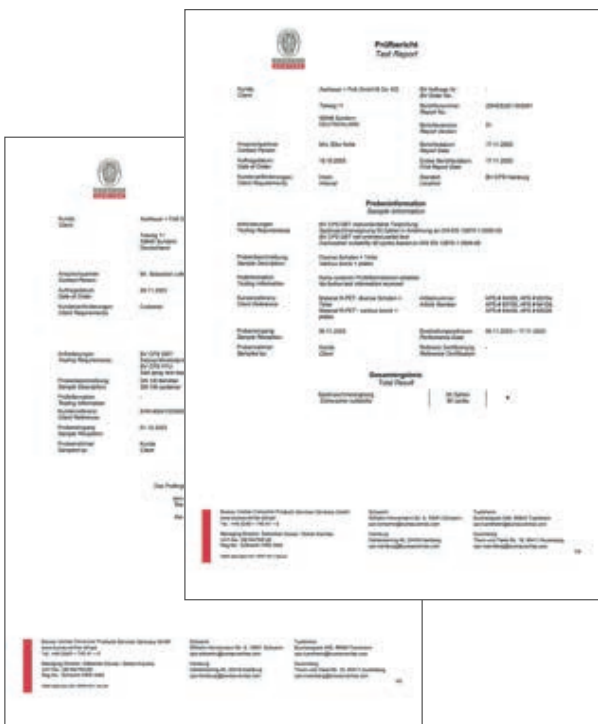

APS products comply with directives of the European Commission. This contains provisions for materials which come into contact with foodstuffs. We work very closely together with certification institutions and testing laboratories and are therefore able to guarantee the compatibility with foodstuffs (German LFGB regulation) of APS products.



Icon-Index

 neuer Artikel new item	 Made in Germany	 Made in the EU	 GN-Größen GN norm
 spülmaschinengeeignet dishwasher-proof	 nicht spülmaschinen-geeignet not dishwasher-proof	 feucht abwaschbar wet washable	 mikrowellengeeignet microwave-proof
 nicht mikrowellen-geeignet not microwave-proof	 nicht für Backofen not for baking oven	 keine direkte Hitze not direct heat	 max. 40°C
 kühlbar for cooling	 Antirutsch-Füßchen non-slip feet	 stapelbar stackable	 bruchsicher shatter-proof
 für Induktionsplatten for induction use	 360° drehbar 360° rotatable	 Eigenmontage self assembly	 nicht für Lebens- mittelkontakt not food safe

Material-Index

 Aluminium sehr leichtes Material; sehr gute elektrische und thermische Leitfähigkeit; korrosionsbeständig; Gebrauchstemperatur bis ca. +500 °C Pflege: niemals scheuernde Hilfsmittel verwenden; nur mit weichem Lappen und Spezialmitteln reinigen; keine Spülmaschinenreinigung!	Aluminium Very light material; very good electrical and thermal conductivity; corrosion-resistant; service temperature up to approx. +500 °C care: never use abrasive cleaners; clean only with a soft cloth and special cleaning agents; not suitable for dishwashers
 Blaublech Blaublech oder Blauglanzblech ist ein kaltgewalztes Feinblech mit fest haftender Eisenoxidschicht. Gebrauchstemperatur bis ca. 360 °C Pflege: nicht spülmaschinengeeignet	Blue steel Blue steel is a cold-rolled thin sheet with a firmly adhering layer of iron oxide. service temperature up to approx. 360 °C care: Not dishwasher-safe
 Edelstahl 18/10 Werkstoff 1.4301; rostfrei; langlebig; gute isolierende Eigenschaften; absolut hygienisch und nicht toxisch; recyclebar; nicht resistent gegen dauerhaften Kontakt mit Chloriden und Säuren (z. B. Kochsalz und Fruchtsäuren); sterilisierbar; Oberfläche lässt sich vielfältig polieren; nicht magnetisch; Gebrauchstemperatur bis ca. 400 °C Pflege: pflegeleicht; maschinell oder per Hand mit milden Spülmitteln; möglichst keine Stahlwolle u. ä. verwenden; nach Erhitzung Schockabkühlung vermeiden	Stainless steel 18/10 Material 1.4301; stainless; durable; good insulating properties; absolutely hygienic and non-toxic; recyclable; not resistant to permanent contact with chlorides and acids (e.g. table salt and fruit acids); sterilisable; surface can be polished in many ways; non-magnetic; service temperature up to approx. 400 °C care: easy to clean; machine or hand wash with mild detergents; if possible, do not use steel wool or similar; Avoid shock cooling after heating.
 Edelstahl (unspezifisch) niedrig nickelhaltige Edelstähle wie 14/4; nicht magnetisch; geringere allgemeine Resistenz als Edelstahl 18/10 Pflege: pflegeleicht; maschinell oder per Hand mit milden Spülmitteln; möglichst keine Stahlwolle u. ä. verwenden; nach Erhitzung Schockabkühlung vermeiden	Stainless steel (unspecific) Stainless steel with low nickel content such as 14/4; non-magnetic; lower general resistance than 18/10 stainless steel care: easy to clean; machine or hand wash with mild detergents; if possible, do not use steel wool or similar; Avoid shock cooling after heating.
 Edelstahl 18/0 Werkstoff 1.4016; rostfrei; langlebig bei entsprechender Pflege; absolut hygienisch und nicht toxisch; gut härtbar, daher idealer Stahl für Tafelmesser, Tablett, Schneidewerkzeuge u. ä.; lässt sich hochglanzpolieren; für Nickelallergiker geeignet; magnetisch; nicht so chemikalienresistent wie Edelstahl 18/10; Gebrauchstemperatur bis ca. 400 °C Pflege: maschinell oder per Hand mit milden Spülmitteln; Ablagerungen von Kalk und Reinigerresten nach dem Spülen unbedingt entfernen; niemals mit Stahlwolle reinigen	Stainless steel 18/0 Material 1.4016; stainless; long-lasting with appropriate care; absolutely hygienic and non-toxic; good hardening properties, therefore ideal steel for table knives, trays, cutting tools, etc.; can be polished to a high gloss; suitable for people allergic to nickel; magnetic; not as resistant to chemicals as stainless steel 18/10; service temperature up to approx. 400 °C care: by machine or by hand with mild detergents; Remove limescale and detergent residues after cleaning; never clean with steel wool



Eisen

nicht rostfrei; charakteristische, strukturierte Oberfläche mit unterschiedlichen Schattierungen; durch wiederholten Schmiedevorgang ist das Material stark verdichtet und sehr hart; langlebig bei entsprechender Pflege

Pflege:

vor erstem Einsatz mit Öl und Kartoffelschalen „einbraten“; später nach jeder Reinigung einfetten; stets trocken lagern

Iron

not rustproof; characteristic, structured surface with different shades; due to repeated forging process, the material is strongly compressed and very hard; long-lasting with appropriate care

care:

before first use, fry with oil and potato peelings; later grease after each cleaning; always store in a dry place



Gusseisen

langlebig bei entsprechender Pflege; geeignet für alle Herdarten (inkl. Induktion); speichert lange Wärme und gibt sie gleichmäßig ab; absolut hygienisch bei unbeschädigter Oberfläche; relativ schweres Material; Überhitzung fast nicht möglich; nicht schlagfest; magnetisch

Pflege:

nach Gebrauch sofort mit heißem Wasser reinigen; bei Fleckenbildung mit Essig nachreinigen; niemals mit Stahlwolle reinigen; milde Spülmittel verwenden; stets trocken lagern



Cast Iron

Long-lasting with appropriate care; suitable for all types of cookers (incl. induction); stores heat for a long time and releases it evenly; absolutely hygienic with undamaged surface; relatively heavy material; overheating is almost impossible; not impact-resistant; magnetic

care:

clean immediately with hot water after use; clean with vinegar if stains form; never clean with steel wool; use mild detergents; always store in a dry place



Verchromter Stahl

nichtedles Metall mit hartem Chromüberzug; nicht säurefest; nach Beschädigung der Chromschicht kein Schutz gegen Umwelteinflüsse

Pflege:

niemals scheuernde Hilfsmittel verwenden; nur mit weichem Lappen

Chrome plated steel

Metal with hard chrome coating; not acid-resistant; after damage to the chrome layer no protection against environmental influences

care:

never use abrasive cleaners; only with a soft cloth



Versilberter Stahl

Edelmetallüberzug; nicht völlig säurefest; nicht über längere Zeit Sonnenlicht aussetzen

Pflege:

niemals scheuernde Hilfsmittel verwenden; nur mit weichem Lappen und Spezialmitteln reinigen; keine Spülmaschinenreinigung!

Silver plated steel

Metal coating; not completely acid-resistant; do not expose to sunlight for long periods of time

care:

never use abrasive cleaners; clean only with a soft cloth and special cleaning agents; not suitable for dishwashers



ABS – Acrylnitril-Butadien-Styrol

sehr gute Oberflächenhärte; temperaturwechselfest; Gebrauchstemperatur bis ca. +100 °C

Pflege:

spülmaschinengeeignet

ABS - acrylonitrile butadiene styrene

very good surface hardness; resistant to temperature changes; service temperature up to approx. +100 °C

care:

dishwasher safe



ACRYL – künstliches Harz

farblos; glasartig; durchsichtig; nicht splinternd; chemisch modifiziert als Plexiglas®; Gebrauchstemperatur ca. -40 °C bis ca. +50 °C

wichtiger Pflegehinweis:

nur handelsübliche Acrylspezialreiniger oder milde alkohol- und ammoniakfreie Reinigungsmittel verwenden; nicht spülmaschinengeeignet

ACRYL - artificial resin

colourless; glass-like; transparent; not splintering; chemically modified as Plexiglas®; service temperature approx. -40 °C to approx. +50 °C

important care advice:

use only commercially available acrylic special cleaners or mild and ammonia-free cleaning agents; not suitable for dishwashers



EVA - Ethylenvinylacetat

weich elastisch; glänzend; Gebrauchstemperatur bis ca. +60 °C

Pflege:

abwaschbar / wasserfest

EVA - ethylene vinyl acetate

soft elastic; glossy; service temperature up to approx. +60 °C

care:

washable / waterproof



GFK – Glasfaserverstärkter Kunststoff

starr; nahezu unzerbrechlich; Gebrauchstemperatur bis ca. +100 °C

Pflege:

spülmaschinengeeignet

GFK - glass-fibre reinforced plastic

rigid; almost unbreakable; service temperature up to approx. +100 °C

care:

dishwasher-safe



MF - Melamin

sehr hart; stoß- und kratzfest; hygienisch; Gebrauchstemp. ca. -30 °C bis +70 °C

Pflege:

säurebeständig; spülmaschinengeeignet

MF - melamine

very hard; impact- and scratch-resistant; hygienic; service temp. approx. -30 °C to +70 °C

care:

acid-resistant; dishwasher safe



MS - Kunststoff

farblos; glasartig; durchsichtig; Gebrauchstemperatur ca. 0 °C bis ca. +70 °C

Pflege:

nicht spülmaschinengeeignet

MS - plastic

colourless; glass-like; transparent; service temperature approx. 0 °C to +70 °C

care:

not dishwasher-safe

**PA - Polyamid**

starr; bruch- und schlagfest; mattglänzend; Gebrauchstemperatur bis ca. +220 °C

Pflege:

spülmaschinengeeignet

PA - polyamide

rigid; break- and impact-resistant; matt glossy; service temperature up to approx. +220 °C

care:

dishwasher-safe

**PC - Polycarbonat**

starr; nahezu unzerbrechlich; sehr stabil; formbeständig in kochendem Wasser; mikrowellengeeignet; Gebrauchstemperatur ca. -30 °C bis ca. +100 °C

Pflege:

spülmaschinengeeignet

PC - polycarbonate

rigid; almost unbreakable; very stable; keeps its shape in boiling water; microwave safe; service temperature approx. -30 °C to approx. +100 °C

care:

dishwasher-safe

**PE - Polyethylen / HDPE – hochdichtes Polyethylen**

hart elastisch; unzerbrechlich; ausreichend formbeständig in heißem Wasser; glänzend; Gebrauchstemperatur ca. -30 °C bis ca. +120 °C

Pflege:

spülmaschinengeeignet

NDPE – niederdichtes Polyethylen

weich elastisch; unzerbrechlich; kurzzeitig formbeständig in heißem Wasser; nicht glänzend; Gebrauchstemperatur ca. -30 °C bis ca. +95 °C

Pflege:

spülmaschinengeeignet

PE - polyethylene / HDPE - high-density polyethylene

hard elastic; unbreakable; sufficiently dimensionally stable in hot water; shiny; service temperature approx. -30 °C to approx. +120 °C

care:

dishwasher safe

NDPE - low density polyethylene

soft elastic; unbreakable; briefly keeps its shape in hot water; not shiny; service temperature approx. -30 °C to approx. +95 °C

care:

dishwasher safe

**PET - Polyethylenterephthalat**

hart elastisch; ausreichend formbeständig in heißem Wasser; glänzend; Gebrauchstemperatur ca. -30 °C bis ca. +55 °C

Pflege:

spülmaschinengeeignet bis 55°C

PET - Polyethylene terephthalate

hard elastic; sufficiently dimensionally stable in hot water; shiny; service temperature approx. -30 °C to approx. +55 °C

care:

dishwasher safe up to 55°C

**PP - Polypropylen**

hart elastisch; unzerbrechlich; umweltschonend recycelbar; mikrowellengeeignet; Gebrauchstemperatur ca. -30 °C bis ca. +75 °C

Pflege:

spülmaschinengeeignet

PP - polypropylene

hard elastic; unbreakable; environmentally friendly recyclable; microwave safe; service temperature approx. -30 °C to approx. +75 °C

care:

dishwasher safe

**PS - Polystyrol**

starr; kratzfest; formbeständig in kochendem Wasser; Gebrauchstemperatur bis ca. +70 °C

Pflege:

spülmaschinengeeignet

PS - polystyrene

rigid; scratch-resistant; keeps its shape in boiling water; service temperature up to approx. +70 °C

care:

dishwasher safe

**PVC - Polyvinylchlorid**

säurebeständig; schwer entflammbar; Gebrauchstemperatur ca. -50 °C bis +60 °C

Pflege:

nicht spülmaschinengeeignet

PVC - polyvinyl chloride

acid-resistant; flame-retardant; service temperature approx. -50 °C to +60 °C

care:

not dishwasher safe

**SAN - Styrol-Acrylnitril**

gute Oberflächenhärte; temperaturwechselfest; Gebrauchstemperatur bis ca. +100 °C

Pflege:

spülmaschinengeeignet

SAN - styrene acrylonitrile

good surface hardness; resistant to temperature changes; service temperature up to approx. +100 °C

care:

dishwasher safe

**Silikon**

hohe thermische Beständigkeit; gute Kälteflexibilität; Gebrauchstemp. ca. -70 °C bis ca. +180 °C

Pflege:

spülmaschinengeeignet

Silicone

high thermal resistance; good low-temperature flexibility; service temperature approx. -70 °C to approx. +180 °C

care:

dishwasher safe

**Tetron**

Kunstfaser: 65 % Polyester, 35 % Viskose

Pflege:

maschinenwaschbar bis 30 °C

Tetron

Artificial fibre: 65 % polyester, 35 % viscose

care:

machine washable up to 30 °C

**Tritan®**

starr; unzerbrechlich; absolut formbeständig; sehr hohe Chemikalienbeständigkeit; Gebrauchstemperatur ca. -30 °C bis ca. +95 °C; nicht mikrowellengeeignet

Pflege:

spülmaschinengeeignet

Tritan®

rigid; unbreakable; keeps its shape in boiling water; very high chemical resistance; service temperature approx. -30 °C to approx. +95 °C; not microwaveable

care:

dishwasher safe



Beton

Werkstoff Beton, coole Optik; handgefertigt

Pflege:

nicht spülmaschinengeeignet

Concrete

Concrete material, cool look; handmade

care:

not dishwasher safe



Porzellan

hitzebeständig bis ca. +220 °C

Pflege:

spülmaschinengeeignet

Porcelain

heat-resistant up to approx. +220 °C

care:

dishwasher safe



Schiefer

Naturschiefer versiegelt; lebensmittelecht;

Pflege:

nicht spülmaschinengeeignet

Slate

Natural slate sealed; food-safe

care:

not dishwasher safe



Holz

lebensmittelecht; nicht spülmaschinengeeignet; naturbedingte Abweichung in Form, Farbe, Maserung und Größe; Abweichungen stellen keinen Mangel dar

Pflege:

Vor dem ersten und nach jedem Gebrauch gründlich mit heißem Wasser und Spülmittel reinigen und nicht längere Zeit im Wasser liegen lassen. Anschließend gut abtrocknen und aufrecht trocknen lassen.

Ihr Holzprodukt pflegen Sie in regelmäßigem Abstand mit etwas geschmacksneutralem und handelsüblichem Speiseöl.

Wood

food-safe; not dishwasher-safe; natural deviations in shape, color, grain in shape, color, grain and size; deviations do not constitute a defect constitute a defect

care:

Clean thoroughly with hot water and washing-up liquid before the first and after each use and do not leave in water for a long time. for a long time. Then dry well and leave to dry upright.

Care for your wooden product at regular intervals with a little tasteless and commercially available cooking oil.

Function-Index



RGB

Die RGB-Funktion ermöglicht anpassbare Lichtfarben durch Rot, Grün und Blau für eine personalisierte Beleuchtung.

RGB

The RGB function allows customizable light colors through red, green, and blue, providing personalized illumination.



CCT

Die CCT-Funktion ermöglicht die Anpassung der Farbtemperatur, was eine variable Lichtstimmung von warmweiß zu kaltweiß ermöglicht.

CCT

The CCT function allows the colour temperature to be adjusted, enabling a variable lighting mood from warm white to cool white.



3-Stufen Dimmbar

Die 3-Stufen Dimmbarkeit bietet eine einfache Anpassung der Helligkeit in drei verschiedenen Stufen.

3-step dimmable

The 3-step dimming enables simple adjustment of the brightness in three different levels.



Fernbedienung

Die Fernbedienung ermöglicht die gleichzeitige Steuerung mehrerer Leuchten und bequeme Anpassung von Einstellungen aus der Ferne.

Remote control

The remote control enables simultaneous control of several lights and convenient adjustment of settings from a distance.



IP54

Der IP54-Standard kennzeichnet die Staub- und Spritzwasserbeständigkeit, was den Einsatz der Leuchten im Freien ermöglicht.

IP54

The IP54 standard indicates resistance to dust and splash water, allowing the lights to be used outdoors.

Index

Artikel-Nr.	Prüfziffer	Seite	00393	4	150	00595	2	514	00746	8	537	00843	4	170, 280	00994	3	158, 289
00011	7	348	00394	1	150	00596	9	515	00747	5	537	00844	1	170, 280	00995	0	158, 289
00012	4	348	00395	8	150	00597	6	515	00750	5	162, 286	00845	8	282	00996	7	158, 289
00013	1	346	00396	5	150	00598	3	515	00751	2	162, 286	00846	5	282	00997	4	161
00017	9	346	00398	9	150	00599	0	557	00752	9	162, 286	00848	9	567	00998	1	160, 569
00018	6	351	00399	6	150	00600	3	520	00753	6	162, 286	00849	6	567	00999	8	160
00019	3	352	00401	6	320	00601	0	521	00754	3	163, 257, 270, 287	00864	9	171, 285	01000	0	149, 160
00020	9	352	00463	4	154, 569	00602	7	521	00755	0	163, 287	00867	0	166, 284	01001	7	157
00021	6	348	00468	9	153, 155, 211, 240, 568, 569	00603	4	520	00756	7	163, 287	00868	7	166, 284	01002	4	157
00022	3	344	00469	6	153, 211, 240, 569	00604	1	520	00757	4	163, 287	00869	4	166, 284	01003	1	157
00023	0	348	00500	6	151, 503	00605	8	521	00758	1	72	00870	0	167, 282	01004	8	157
00025	4	352	00502	0	151, 503	00606	5	521	00759	8	72	00871	7	167, 282	01010	9	170, 280
00026	1	352	00506	8	151, 503	00607	2	521	00760	4	73	00873	1	167, 282	01011	6	170, 280
00027	8	354	00508	2	151, 503	00610	2	547	00761	1	163, 283	00874	8	167, 282	01012	3	170, 280
00029	2	354	00510	5	151, 503	00611	9	547	00762	8	70	00875	5	167, 282	01013	0	171, 281
00030	8	349	00511	2	151, 503	00612	6	547	00763	5	70	00876	2	167, 282	01014	7	171, 281
00031	5	355	00515	0	151, 503	00615	7	128, 483, 575	00765	9	329, 490	00877	9	167, 282	01015	4	171, 281
00032	2	313	00530	3	152, 504	00617	1	128, 482, 483	00766	6	330, 491	00878	6	171, 283	01016	1	169, 282
00033	9	330, 492	00531	0	152, 504	00618	8	128, 483	00768	0	329, 330, 490, 491	00880	9	169	01017	8	169, 282
00036	0	349	00532	7	152, 504	00619	5	128, 483	00771	0	539	00881	6	169	01018	5	557
00037	7	347	00533	4	152, 504	00620	1	128, 483	00772	7	310, 540	00882	3	169	01019	2	557
00040	7	544	00534	1	152, 504	00621	8	128, 483	00775	8	310	00883	0	69	01020	8	556
00042	1	544	00535	8	152, 504	00623	2	293	00776	5	310	00884	7	69	01021	5	281
00046	9	154, 569	00536	5	152, 504	00625	6	293	00777	2	310	00885	4	69	01022	2	281
00047	6	154	00537	2	152, 504	00626	3	293	00778	9	310	00886	1	69	01023	9	170, 281
00048	3	509	00538	9	152, 504	00627	0	293	00779	6	310, 540	00887	8	166, 284	01024	6	280
00050	6	509	00539	6	152, 504	00629	4	521	00780	2	540	00888	7	165, 285	01025	3	280
00052	0	508	00540	2	152, 504	00634	8	329, 492	00785	7	540	00889	4	165, 285	01026	0	287, 557
00054	4	507	00541	9	152, 504	00636	2	78	00786	4	540	00899	1	165, 285	01050	5	96, 290
00056	8	507	00542	6	152, 504	00637	9	78	00787	1	540	00905	9	167, 281	01051	2	97, 291
00060	5	345	00543	3	152, 504	00650	8	431	00788	1	540	00906	6	167, 281	01052	9	97, 291
00063	6	313	00547	1	151, 503	00651	5	431	00790	1	164, 285	00907	3	170, 281	01053	6	96, 290
00064	3	147	00548	8	151, 503	00652	2	147	00791	8	164, 285	00908	0	170, 281	01054	3	97, 291
00065	0	147	00549	5	151, 503	00662	1	519	00792	5	164, 285	00910	3	44	01055	0	97, 291
00067	4	147	00552	5	152, 504	00664	5	519	00793	2	164, 285	00911	0	44, 69	01056	7	96, 290
00069	8	71, 346	00553	2	152, 504	00666	9	519	00794	9	98	00912	7	44	01057	4	96, 290
00070	4	347	00554	9	152, 504	00668	3	519	00795	6	98	00914	1	44	01058	1	96, 290
00071	1	345	00555	6	152, 504	00670	6	519	00796	3	98	00937	0	160, 288	01309	4	141
00074	2	349	00558	7	507	00671	3	516	00805	2	74	00941	7	158, 289	01310	0	141
00076	6	348	00559	4	507	00672	0	516	00806	9	69, 74	00942	4	158, 289	01311	7	141
00078	0	345	00560	0	506	00673	7	516	00807	6	74	00943	1	158	01312	4	141
00081	0	140	00561	7	506	00677	5	273	00808	3	166, 288	00945	5	158, 289	01313	1	141
00082	7	140	00562	4	506	00685	0	527	00809	0	168	00947	9	159, 288	01314	8	141
00084	1	140	00563	1	506	00686	7	527	00810	6	165, 284	00953	0	68	01317	9	141
00090	2	508	00564	8	506	00687	4	527	00811	3	165, 284	00954	7	68	01318	6	141
00091	9	508	00564	8	506	00688	1	527	00812	0	165, 268, 284	00955	4	69	01322	3	141
00092	6	544	00568	6	507	00691	1	273	00813	7	165, 268, 284	00956	1	69	01323	0	141
00093	3	544	00570	9	507	00692	8	273	00814	4	165, 284	00957	8	69	01324	7	141
00094	0	544	00572	3	346	00693	5	273	00815	1	74	00958	5	62	01332	2	141
00098	8	544	00574	7	509	00694	2	547	00816	8	74, 569	00959	2	68	01335	3	141
00099	5	544	00576	1	509	00695	9	547	00817	5	168	00960	8	63, 161	01338	4	141
00106	0	545	00578	5	509	00696	6	547	00820	5	148	00966	0	156	01348	3	141
00110	7	544	00580	8	510	00697	3	547	00821	2	148	00968	4	160	01699	6	149, 317
00113	8	544	00581	5	315, 505	00699	7	273	00822	9	148	00969	1	160	01712	2	141
00311	8	355	00582	2	506	00700	0	349	00825	0	148, 567	00971	4	159, 289, 304	02038	2	355
00381	1	140	00583	9	506	00711	6	516	00826	7	148, 567	00973	8	28, 30, 157, 386	02039	9	355
00382	8	140	00584	6	506	00712	3	516	00827	4	146, 567	00975	2	160, 569	02311	6	142
00383	5	140	00585	3	506	00713	0	516	00828	1	146, 567	00979	0	31, 156, 158	03038	1	342
00384	2	140	00586	0	509	00714	7	516	00830	4	45, 148	00984	4	161, 289	03039	8	342
00385	9	140	00587	7	515	00715	4	516	00831	1	518	00986	8	159, 288	03098	5	342
00388	0	140	00588	4	514	00716	1	516	00832	8	518	00987	5	159, 288	03099	2	342
00389	7	150	00589	1	514	00721	5	516	00833	5	518	00988	2	158, 289	03622	2	93, 241
00391	0	150	00590	7	514	00722	2	516	00834	2	518	00989	9	63, 161	03623	9	93, 241
00392	7	150	00591	4	514	00723	9	516	00835	9	163, 287	00990	5	30, 157	03824	0	140
			00592	1	515	00730	7	516	00840	3	556	00991	2	30, 157	04010	6	342
			00593	8	515	00740	6	537	00841	0	556	00992	9	30, 157	04011	3	342
			00594	5	515	00744	4	537	00842	7	556	00993	6	30, 157	04015	1	342
						00745	1	537				04446	3	316			

06401	0	147, 567	10400	6	110, 111, 454, 455	10573	7	457	10803	5	119	11043	4	139, 188, 217, 379, 564	11597	2	104
06501	7	570				10574	4	457	10804	2	119				11598	9	104
06503	1	147	10403	7	110, 111, 454, 455	10575	1	457	10807	3	119	11044	1	67, 139, 188, 217, 379, 564	11599	6	104
06504	8	570	10404	4	111, 455	10576	8	457	10808	0	119	11051	9	60, 571	11616	0	30
06506	2	570	10405	1	111, 455	10577	5	457	10809	7	119	11052	6	60, 571	11617	7	30
06510	9	147, 241, 570	10409	9	112, 455	10578	2	457	10812	7	119	11053	3	571	11619	1	156
06512	3	45, 67, 74, 241, 570	10410	5	112, 455	10579	9	457	10814	1	119	11054	0	571	11620	7	28, 30, 386
06515	4	570	10411	2	112, 455	10585	0	457	10818	9	112	11055	7	144, 502, 567	11621	4	28, 29, 30, 386, 387
06517	8	570	10415	0	113	10586	7	457	10830	1	117, 120	11056	4	65, 144, 219, 502, 567	11622	1	29, 387
06519	2	45, 74, 154, 155, 208, 209, 211, 569	10416	7	113	10587	4	457	10833	2	117				11623	8	29, 387
			10417	4	113	10588	1	457	10836	3	22, 116	11065	6	139	11625	2	311
			10418	1	113	10589	8	457	10837	0	22, 116	11070	0	366, 369, 379, 563	11626	9	28, 30, 386
06520	8	45, 67, 74, 153, 154, 155, 208, 210, 211, 569	10422	8	115	10661	1	21, 38, 39, 575	10838	7	22, 116	11071	7	366, 369, 378, 379, 563	11627	6	29, 30, 387
			10424	2	114, 115	10663	5	117	10839	4	22, 116	11072	4	366, 369, 379, 563	11628	3	29, 387
			10426	6	114, 115	10668	0	103	10840	0	117	11073	1	72, 379, 563	11629	0	29, 387
06521	5	45, 74, 154, 155, 211, 569	10427	3	114	10690	1	73, 124, 283	10841	7	112, 455	11074	8	379, 563	11645	0	31, 156
			10428	0	114, 115	10691	8	124	10849	3	110, 454	11077	5	31, 32, 72, 156, 565	11649	8	311
06525	3	155, 211, 569	10430	3	115	10692	5	125	10850	9	117	11075	5	31, 32, 72, 156, 565	11650	4	311
06701	1	147, 567	10435	8	114	10693	2	125	10851	6	112, 115, 455				11651	1	311
08201	4	140	10440	2	116	10700	7	118, 120	10853	0	110, 112, 454, 455	11100	4	31, 139	11671	9	129, 413
09010	1	142	10450	1	110, 454	10701	4	119	10855	4	110, 112, 454	11101	1	34, 37, 575	11672	6	129, 413
09013	2	142, 565	10451	8	110, 454	10703	8	119	10867	7	119	11110	3	139	11675	7	399
09023	1	566	10500	3	458	10704	5	119	10870	7	22, 113	11119	6	25, 247	11683	2	399
09080	4	149	10501	0	114, 115, 458	10707	6	119	10871	4	22, 113	11150	9	138	11705	1	73, 124
09082	8	37	10502	7	458	10708	3	119	10872	1	22, 113	11155	4	138	11706	8	73, 124
09083	5	37	10503	4	458	10709	0	119	10873	8	22, 113	11244	5	405	11711	2	58
09090	3	35	10504	1	458	10710	6	119	10889	9	574	11295	7	138, 564	11712	9	58
09091	0	35	10505	8	113, 459	10711	3	119	10907	0	119	11300	8	138, 564	11713	6	58
09093	4	35	10506	5	273, 493	10712	0	119	10910	0	131	11305	3	138, 564	11714	3	58
09094	1	35	10509	6	459	10713	7	119	10911	7	131	11411	1	75	11719	8	28, 386
09099	6	149	10510	2	459	10714	4	119	10912	4	131	11413	5	75	11720	4	86
09100	9	34	10511	9	459	10715	1	119	10913	1	131	11414	2	75	11721	1	28, 386
09104	7	34	10512	6	458, 459	10716	8	119	10914	8	131	11444	9	75	11722	8	29, 387
09200	6	34	10513	3	458	10717	5	119	10915	5	129	11446	3	75	11723	5	28, 386
09204	4	34	10514	0	458	10718	2	112, 113, 455	10916	2	129	11455	5	75	11724	2	29, 387
			10515	7	458	10720	5	118	10917	9	129	11495	1	105, 108	11726	6	283, 311
1			10516	4	458	10721	2	123	10921	6	130	11496	8	105	11727	3	171, 283, 311
10318	4	490	10517	1	458	10722	9	123	10922	3	130	11497	5	105	11728	0	57, 107
10319	1	490	10520	1	124, 283	10738	0	18, 123, 444	10923	0	130	11498	2	105	11729	7	57, 107
10320	7	490	10525	6	144, 459	10739	7	18, 123, 444	10924	7	130	11499	9	105	11740	2	56
10321	4	329, 490	10526	3	458, 459	10741	0	123, 126	10990	2	132, 486	11503	3	31	11747	1	352
10322	1	489	10527	0	459	10742	7	123, 126	10991	9	132, 282, 486	11505	7	31	11748	8	352
10323	8	489	10528	7	459	10748	9	125	10992	6	132, 486	11522	4	109	11750	1	351
10325	2	489	10529	4	459	10749	6	125	10993	3	133, 487	11523	1	108, 109	11752	5	89, 350, 381, 430
10326	9	489	10530	0	459	10750	2	117	10994	0	133, 282, 487	11524	8	108	11753	2	89, 350, 381, 430
10327	6	489	10531	7	459	10757	1	117	10995	7	132, 486	11526	2	108	11754	9	89, 350, 381, 430
10328	3	488	10532	4	459	10764	9	122	10996	4	132, 486	11527	9	108	11755	6	351
10329	0	488	10533	1	459	10766	3	122	11000	7	139	11528	6	109	11762	4	87
10330	6	488	10534	8	459	10769	4	125	11008	3	27, 31, 33, 365, 565	11529	3	109	11763	1	87
10331	3	488	10535	5	459	10770	0	124	11010	6	31, 32, 33, 365, 565	11540	8	33	11765	5	87
10332	0	488	10536	2	459	10771	7	125				11542	2	36	11767	9	86
10334	4	488	10540	9	335, 456	10775	5	125	11013	7	563	11543	9	36	11768	6	86
10335	1	488	10541	6	335, 456	10776	2	125	11016	8	74, 565	11544	0	32	11770	9	87
10336	8	488	10542	3	335, 456	10777	9	21, 38, 39, 40, 119, 575	11018	2	26, 27, 365, 565	11547	7	32	11771	6	87
10350	4	488	10560	7	457				11020	5	139	11555	2	366	11775	4	133, 487
10351	1	488	10561	4	457	10778	6	103	11021	2	45, 562	11556	9	43	11776	1	133, 487
10352	8	131	10562	1	457	10781	6	575	11022	9	562	11557	6	62	11778	5	88
10353	5	130	10563	8	457	10782	3	31, 156, 575	11026	7	45, 366, 562	11558	3	62	11780	8	88
10354	2	130	10564	5	457	10788	5	118	11027	4	366, 369, 562	11563	7	133, 487	11781	5	88
10355	9	489	10565	2	457	10789	2	118	11028	1	366, 562	11572	9	43	11795	2	106
10360	3	489	10566	9	457	10791	5	31, 32, 33, 36, 575	11032	8	139	11573	6	43	11805	8	101
10361	0	489	10567	6	457				11040	3	139	11574	3	133, 487	11807	2	101
10362	7	489	10568	3	457	10792	2	122, 444	11041	0	139, 188, 217, 379, 562, 564	11575	0	133, 487	11810	2	39
10370	2	135, 279, 334, 496	10569	0	457	10795	3	118	11042	7	139, 188, 217, 369, 379, 562, 564	11576	7	133, 487	11811	9	38, 39
10371	9	135, 279, 334, 496	10570	6	457	10796	0	118				11595	8	104, 109	11812	6	38, 39
10372	6	135, 279, 334, 496	10571	3	457	10800	4	118				11596	5	104			
			10572	0	457	10801	1	119									
						10802	8	120									

11813	3	38	12010	5	565	13377	8	545	15332	5	385	16014	9	137,333,495	30072	9	543
11815	7	39	12065	5	139	13378	5	545	15334	9	385	16015	6	137,333,495	30075	0	433,543
11816	4	38,39	12100	3	139	13379	2	545	15335	6	385	16016	3	136,137,332,333,494,495	30076	7	433,543
11817	1	38,574	12224	6	400	13380	8	143,292	15336	3	385	16017	0	137,333,495	30077	4	433,543
11818	8	38,574	12225	3	400	13382	2	146	15337	0	385	17000	1	337,437	30078	1	433,543
11840	9	100	12232	1	42,400	13385	3	146	15350	9	566	17001	8	337,437	30108	5	316,505
11841	6	100	12233	8	399	13622	9	146	15351	6	566	17002	5	337,437	30110	8	316,505
11845	4	40,574	12235	2	400	13965	7	102	15400	1	227,243,573	17003	2	338,339,438,439	30111	5	144,501
11846	1	38,39	12236	9	399	13966	4	59	15401	8	227	17004	9	338,339,438,439	30112	2	144,501
11847	8	39,574	12243	7	405	13980	0	21	15402	5	227	17005	6	338,339,438,439	30113	9	144,501
11848	5	38,39	12244	4	405	13981	7	21	15403	2	227	17006	3	338,438	30114	6	145,502
11849	2	39,574	12245	1	398	13987	9	23,102	15404	9	227,243,573	17007	0	338,339,438,439	30115	3	144,501
11859	1	106,574	12249	9	398,399	13990	9	20	15416	2	227,243,573	17020	9	340,440	30116	0	144,501
11865	2	105,243,573,574	12265	9	51,53,406	13995	4	23	15417	9	227	17021	6	340,341,440,441	30117	7	144,501
11866	9	243,573,574	12266	6	50,51,53,406	14000	4	15	15418	6	227	17022	3	340,341,440,441	30118	4	145,501
11868	3	38,39,105,574	12272	7	85,403	14001	1	15,16	15419	3	227	17023	0	340,440	30119	1	145,501
11875	1	40,104,574	12275	8	85,403	14002	8	15,16	15420	9	227,243,573	17910	3	25	30130	6	143,292,500
11878	2	38,39,40,104,574	12276	5	85,403	14003	5	15	15421	6	226,227	17922	6	25	30131	3	143,292,500
11879	9	346,574	12285	7	18,403,404	14004	2	15,16	15424	7	226,227	18121	2	567	30132	0	143,264,292,500
11881	2	559	12287	1	129,413	14005	9	15,16	15425	4	227	18380	3	566	30133	7	143,292,500
11884	3	78	12291	8	394,395,404	14006	6	15	15449	0	227	18387	2	36,365,566	30134	4	143,292
11885	0	78	12292	5	404	14007	3	15	15450	6	226,227	18388	9	36,37,241,365,566	30140	5	144,292,500
11887	4	41	12294	9	404	14008	0	15	15451	3	227	18389	6	26,365	30141	2	144,292,500
11888	1	41	12295	6	85,390,392,393,394,395,397,403,404	14009	7	15	15452	0	227	18621	7	567	30142	9	144,292,500
11889	8	41	12296	3	393,404	14010	3	19,66	15453	7	227	30000	2	99	30148	1	144,502,567
11891	1	41	12299	4	404	14011	0	19,66	15454	4	227	30001	9	99	30149	8	144,502,567
11901	7	401	12300	7	398,422	14012	7	19,66	15455	1	227	30002	6	99	30200	6	382
11910	9	401	12310	6	405	14013	4	19,66	15456	8	227	30003	3	99	30206	8	384
11915	4	401	12315	1	134,412,485	14014	1	19,66	15457	5	227	30010	1	50	30207	5	384
11916	1	401	12316	8	134,412,485	14015	8	18,111	15458	2	226,227	30011	8	50	30208	2	384
11917	8	401	12322	9	396	14016	5	18,111	15459	9	44	30013	2	50	30209	9	63,373,384
11921	5	353	12323	6	396	14019	6	18,123	15460	5	227	30014	9	50	30210	5	382
11922	2	353	12324	3	397	14021	9	16	15461	2	227,243,573	30015	6	51	30220	4	382
11930	7	355	12325	0	397	14022	6	16	15462	9	226,227,243,573	30016	3	51	30230	3	382
11931	4	355	12329	8	84,402	14030	1	17	15467	4	227,243,573	30017	0	51	30240	2	382
11940	6	432	12330	4	84,402	14031	8	17	15473	5	228	30018	7	51	30250	1	382
11945	1	427	12335	9	84,402	14032	5	17	15474	2	228	30019	4	51	30260	0	547
11946	8	427	12336	6	84,402	14033	2	17	15475	9	228	30021	7	99	30263	1	547
11947	5	427	12337	3	84,402	14034	9	17	15477	3	228	30024	8	50	30270	9	382
11948	2	90,428	12338	0	84,402	14035	6	17	15485	8	228	30045	3	543	30276	1	383
11949	9	90,428	12339	7	84,85,402,403	14036	3	16	15504	6	228	30046	0	542	30277	8	383
11950	5	432	12350	2	398	14037	0	16	15505	3	226,228	30047	7	542	30279	2	368
11951	2	90,428	12352	6	391	14038	7	18	15506	0	44,85,226,228,403	30048	4	542	30280	8	368
11952	9	90,428	12353	3	391	14039	4	18	15513	8	95,228	30049	1	542	30281	5	368
11954	3	91,429	12354	0	391	14040	0	18	15514	5	95,226,228	30050	7	21	30282	2	368
11955	0	23,91,429	12360	1	400	14050	9	18,403	15620	3	67	30052	1	21	30283	9	368
11960	4	91,429	12366	3	391,394	14940	3	24	15621	0	67,569	30057	6	542	30285	3	368
11965	9	90,428	12366	3	391,394	14941	0	24	15622	7	67,569	30058	3	543	30286	0	368
11966	6	90,362,428	12370	0	391	14953	3	27	15623	4	67	30059	0	542	30299	0	361
11969	7	41	12371	7	391	14954	0	27	15921	1	312	30061	3	542	30310	2	383
11970	3	101	12372	4	391	14956	4	27	15925	9	312	30062	0	542	30329	4	29,387
11971	0	103	12393	9	394,397	14965	6	102	15926	6	312	30063	7	542	30331	7	29,387
11972	7	103	12394	6	393	14966	3	59	16000	2	136,332,494	30065	1	433,546	30332	4	445
11973	4	103	12396	0	395	14970	0	26	16001	9	136,332,494	30066	8	433,546	30333	1	453
11974	1	103	12397	7	391,395	14980	9	21	16002	6	136,332,494	30067	5	433,546	30334	8	64,567
11975	8	101	12398	4	395	14981	6	21	16003	3	137,333,495	30068	2	433,546	30335	5	60
11977	2	341,426,441	12399	1	395	14987	8	23,102	16004	0	137,333,495	30069	9	433,546	30336	2	65,219
11978	9	423	12403	5	394,397	14990	8	20	16005	7	137,333,495	30070	5	433,546	30337	9	65,379
11979	6	426	12404	2	393	14995	3	23	16006	4	137,333,495	30071	2	433,546	30338	6	65,567
11980	2	106	12483	7	394	15215	1	229	16007	1	136,137,332,333,494,495	30063	7	542	30339	3	64
11981	9	106	12484	4	394	15216	8	229	16008	8	137,333,495	30065	1	433,546	30340	9	371
11986	4	106	12879	8	346,574	15217	5	229	16009	5	136,332,494	30066	8	433,546	30341	6	371
11998	7	91,352,429	12940	5	24	15320	2	228,385	16010	1	136,332,494	30067	5	433,546	30345	4	371
11999	4	91,352,429	12941	2	24	15322	6	228,385	16011	8	136,332,494	30068	2	433,546	30346	1	371
12000	6	139	12990	0	478	15324	0	228,385	16012	5	137,333,495	30069	9	433,546	30347	8	371
12008	2	565	13122	4	146	15326	4	385	16013	2	137,333,495	30070	5	433,546	30348	5	371
						15331	8	385				30071	2	433,546	30350	8	371

30351	5	371	33215	7	61	36037	2	476	40137	2	364	40293	5	26, 29, 362, 387	40510	3	331, 492
30355	3	370	33216	4	61	36038	9	451	40139	6	364	40294	2	26, 365	40511	0	299
30356	0	169, 282, 370	33217	1	61	36044	0	446	40140	2	364	40295	9	26, 365	40516	5	273, 464
30360	7	371	33220	1	61, 571	36045	7	446	40144	0	43, 364	40296	6	361	40517	2	273, 464
30361	4	371	33232	4	43	36046	4	446	40148	8	364	40297	3	361	40535	6	303
30370	6	371	33238	6	61	36048	8	448	40149	5	365	40299	7	361	40536	3	303
30371	3	371	33246	1	106, 278	36052	5	448	40150	1	365, 366	40310	9	296	40537	0	303
30380	5	372	33248	5	61	36053	2	448	40152	5	364	40311	6	296	40538	7	307
30385	0	372	33249	2	93	36054	9	448	40153	2	365	40312	3	296	40539	4	307
30390	4	372	33250	8	93	36055	6	443	40159	4	364	40313	0	296	40540	0	304
30395	9	372	33251	5	93	36056	3	449	40179	2	367	40320	8	296	40541	7	304
30396	6	372	33252	2	93	36057	0	448	40182	2	367	40330	7	300	40543	1	309
30410	9	378	33255	3	95, 99	36062	4	449	40185	3	264	40331	4	300	40544	8	309
30411	6	378	33256	0	95, 99	36063	1	449	40186	0	149, 261	40333	8	300	40545	5	309
30412	3	379	33260	7	93	36066	2	443	40187	7	149, 261	40410	6	295	40546	2	303
30413	0	379	33261	4	93	36068	6	445	40188	4	149, 261	40411	3	295	40547	9	303
30414	7	378	33262	1	93	36069	3	445	40189	1	383	40412	0	295	40548	6	303
30415	4	378	33269	0	93, 98	36074	7	450	40190	7	383	40414	4	301	40549	3	305
30416	1	378	33270	6	93, 98	36075	4	453	40191	4	364	40415	1	296	40550	9	305
30417	8	378	33271	3	93, 98	36077	8	446	40192	1	364	40416	8	308	40551	6	305
30418	5	378	33272	0	93	36087	7	448	40193	8	364	40417	5	308	40552	3	305
30420	8	377	33273	7	93	36090	7	452	40194	5	364	40418	2	308	40553	0	57, 107, 304
30421	5	377	33280	5	95	36095	2	127, 447	40195	2	364	40419	3	300	40554	7	57, 107, 304
30422	2	377	33281	2	95	36096	9	127, 447	40196	9	364	40424	3	300	40555	4	169, 283, 301, 303
30423	9	377	33282	9	94, 215, 293	36099	0	73, 452	40198	3	366	40435	9	294	40556	1	169, 282, 283, 301, 303
30424	6	377	33288	1	45	36100	3	127, 447	40200	3	314	40436	6	294	40557	8	307
30425	3	374	33292	8	154, 569	36101	0	127, 447	40201	0	314	40437	3	294	40558	5	307
30426	0	374	33293	5	154, 569	36102	7	478	40202	7	314	40438	0	294	40561	5	309
30427	7	374	33294	2	154, 155, 568, 569	36103	4	478	40203	4	314	40439	7	294	40562	2	309
30428	4	374	33295	9	154, 155, 568, 569	36104	1	452	40204	1	314	40440	3	296	40563	9	309
30429	1	374	33296	6	154, 569	36105	8	452	40205	8	314	40441	0	296	40570	7	302
30430	7	380	33297	3	154, 155, 569	36106	5	127, 444	40206	5	314	40442	7	294	40571	4	302
30431	4	380	33299	3	154, 155, 569	36107	2	127, 444	40207	2	315	40445	8	299	40572	1	302
30435	2	380	33300	0	54	36108	9	127, 444	40208	9	314	40446	5	299	40573	8	302
30436	9	380	33301	7	55	36109	6	127, 444	40212	6	369	40450	2	296	40574	5	302
30437	6	380	33302	4	54	36111	9	127, 444	40214	0	369	40453	3	301	40575	2	302
30438	3	380	33302	4	54	36112	6	127, 444	40216	4	369	40454	0	301	40576	9	302
30439	0	380	33303	1	55, 94	36115	7	443, 445	40220	1	363	40455	7	298	40577	6	302
30440	6	370	33304	8	54, 55, 94	36116	4	445	40222	5	363	40457	1	298	40578	3	308
30441	3	370	33305	5	73, 94	36120	1	444	40223	2	362	40458	8	298	40579	0	308
30442	0	370	33306	2	46, 92	36121	8	444	40224	9	363	40461	8	297, 298	40580	6	306
30443	7	370	33307	9	92	36122	5	452	40225	6	362	40462	5	297, 298	40581	3	306
30444	7	370	35065	6	406	36123	2	452	40226	3	363	40463	2	298	40582	0	306
30445	1	370	35343	5	406	36124	9	452	40227	0	362	40464	9	298	40583	7	306
30446	8	370	35711	2	316	36125	6	256, 450	40228	7	363	40470	0	297	40600	1	262
30450	5	370	35712	9	316	36126	3	450	40229	4	362	40472	4	297	40601	8	159, 166, 262
30451	2	370	35716	7	73, 124, 316	36127	0	256, 450	40230	0	363	40474	8	297	40602	5	262
30452	9	375	35720	4	315	36128	7	450	40240	9	363	40476	2	297	40603	2	159, 262
30453	6	375	35730	3	315	36129	4	451	40242	3	108, 363	40478	6	297	40604	9	265
30454	3	375	35734	1	315	36130	0	126, 447	40243	0	108, 362	40480	9	297	40605	6	263
30455	0	375	35912	3	316	36131	7	452	40244	7	363	40482	3	300	40606	3	263
30470	3	376	36003	7	443	36140	9	53, 71, 451	40245	4	362	40485	4	299	40607	0	263
30471	0	376	36004	4	443	36233	8	315	40246	1	363	40486	1	331, 491	40610	0	262
30472	7	376	36010	5	467	36323	6	315	40247	8	362	40487	8	331, 492	40611	7	262
30473	4	376	36011	2	467	38202	2	140	40249	2	362	40488	5	329, 490	40612	4	262
30500	7	52	36013	6	476	4			40260	7	363	40490	8	331, 491	40613	1	262
30501	4	52	36015	0	477	40007	8	353, 367	40262	1	363	40494	6	331, 491	40616	2	263
30502	1	52	36016	7	477	40009	2	353, 367	40263	8	363	40498	4	491	40617	9	263
30503	8	53	36017	4	477	40010	8	353, 367	40264	5	363	40499	1	491	40618	6	263
30504	5	53	36020	4	442	40011	5	353, 367	40270	6	363	40501	1	310	40620	9	262
33202	7	94	36021	1	442	40012	2	353, 367	40272	0	363	40503	5	310	40621	6	262
33206	5	59	36025	9	442	40013	9	353, 367	40274	4	363	40504	2	169, 282, 309	40622	3	262
33207	2	59	36026	6	442, 445	40110	5	142	40276	8	363	40505	9	309	40623	0	262
33208	9	60	36028	0	442, 445	40130	3	353, 367	40290	4	26, 109, 362	40506	6	331, 491	40624	7	262
33209	6	60, 571	36030	3	451	40131	0	353, 367	40291	1	26, 109, 362	40507	3	310	40625	4	159, 262, 288
33210	2	62	36032	7	449	40132	7	364	40292	8	26, 29, 362, 387	40508	0	330, 491	40626	1	262
33211	9	61	36033	4	476	40135	8	364				40509	7	330, 491			
33212	6	61	36034	1	449												
33214	0	61															

40627	8	262	40726	8	257, 270	50605	3	360	60525	1	324	71490	8	17, 28, 76, 127, 344, 346, 386, 447	75841	4	526
40628	5	262	40727	5	257, 270	50606	0	360	60526	8	325				75842	1	526
40629	2	262	40728	2	270	50607	7	60, 360	60527	5	324	71491	5	346	75843	8	526
40630	8	263	40729	9	163, 270, 287	50608	4	360	60528	2	323	71492	2	349	75844	5	526
40631	5	263	40730	5	260	50612	1	360	60530	5	322	71493	9	349	75850	6	523
40632	2	266	40731	2	260	50620	6	361	60531	2	322	71494	6	349	75851	3	523
40636	0	168, 266	40732	9	260	50621	3	361	60536	7	328	71495	3	345	75852	0	523
40637	7	266	40733	6	260	50622	0	361	60537	4	328	71496	0	344	75853	7	479, 523
40638	4	266	40734	3	260	50623	7	361	60540	4	322	71497	7	344	75854	4	479, 523
40640	7	263, 329, 489	40735	0	260	50624	4	361	60541	1	322	71510	3	347	75855	1	479, 523
40642	1	261	40736	7	260	50625	1	361	60542	8	321	71512	7	347	75860	5	522
40643	8	261	40737	4	260	50626	8	361	60543	5	328	71512	7	347	75861	2	522
40644	5	261	40738	1	260	50627	5	361	60544	2	327	71513	4	347	75862	9	522
40645	2	266	40740	4	261	50630	5	360	60545	9	327	71516	5	347	75863	6	522
40646	9	266	40741	1	261	50631	2	360	60546	6	327	71520	2	344	75864	3	522
40647	6	266	40742	8	261	50644	2	369	60551	0	325	71521	9	343	75865	0	522
40654	4	264	40752	7	570	50702	9	359	60552	7	326	71522	6	343	75866	7	522
40655	1	143, 243, 264, 292, 500, 573	40760	2	271	50707	4	359	60554	1	326	71523	3	343	75866	7	522
40656	8	143, 243, 264, 292, 500, 573	40761	9	271	50710	4	358	60554	1	326	71527	1	343	75867	4	522
40657	5	264	40762	6	271	50712	8	358	60580	0	318	71528	8	343	75868	1	522
40658	2	264	40763	3	271	50722	7	359	60581	7	318	71529	5	343	75869	8	522
40659	9	264	40764	0	271	50800	2	360	60582	4	318	71531	8	344	75900	8	517
40660	5	261	40765	7	271	50801	9	360	60583	1	319	73502	6	552	75902	2	517
40661	2	267	40766	4	271	50802	6	360	60584	8	319	73505	7	552	75903	9	517
40662	9	267	40767	1	271	50803	3	360	60585	5	319	73506	4	552	75904	6	517
40663	6	267	40768	8	271	50805	7	360	60586	2	319	73507	1	552, 553	75906	0	517
40664	3	267	40770	1	79	50806	4	360	61190	0	142	73507	1	552, 553	75907	7	517
40665	0	267	40771	8	79	50807	1	44, 360	61280	8	142	73508	8	552	75908	4	517
40666	7	267	40772	5	79	50808	8	360	61400	0	142	73509	5	552	75912	1	517
40667	4	267, 313	40773	2	79	50808	8	360	65060	2	317, 407	73510	1	552	77315	8	559
40668	1	267, 313	40774	9	79	50815	6	360	65061	9	407	73511	8	552	77338	7	541
40669	8	267	40775	6	79	50817	0	360	65062	6	407	73513	2	552	79000	1	46
40670	4	143, 159, 169, 264, 292, 500	40776	3	79	50823	1	360	66900	0	511	73515	6	553	79001	8	46
40676	6	91, 269, 429	40776	3	79	50905	4	358	66901	7	511	73750	1	554	79002	5	46
40677	3	282	40780	0	258	50908	5	358	66902	4	511	74201	7	537	79003	2	46
40680	3	269	40781	7	258	50910	8	358	66904	8	551	74402	8	539	79004	9	46, 573
40681	0	269	40782	4	258	50913	9	358	66905	5	498	74404	2	539	79005	6	46, 573
40685	8	164, 171, 264, 285	40783	1	259	50915	3	358	66906	2	498	74700	5	538	79006	3	49, 425
40686	5	171, 264, 283	40784	8	259	50918	4	358	66907	9	121, 499	74701	2	538	79007	0	49, 425
40690	2	265, 373	40785	5	259	6			66908	6	121, 499	74702	9	538	79008	7	46
40691	9	265, 373	40786	2	259	60002	7	324	66909	3	121, 499	74703	6	538	79009	4	46
40692	6	265, 373	40790	9	272	60012	6	325	66910	9	497	74705	0	538	79010	0	48
40693	3	265, 373	40791	6	272	60014	0	323	66911	6	497	74706	7	538	79011	7	48
40694	0	265, 373	40792	3	272	60015	7	325	66912	3	497	74707	4	538	79012	4	48
40695	7	265, 373	40793	0	272	60016	4	323	66913	0	497	74721	0	539	79013	1	48
40700	8	257	40794	7	272	60018	8	323	66914	7	497	74722	7	539	79014	8	47
40701	5	257	40795	4	272	60019	8	323	66915	4	497	74731	9	541	79015	5	47
40702	2	257	40799	5	354	60019	5	325	66916	1	497	74750	0	492	79016	2	47
40703	9	257	40800	2	354	60037	9	320	66917	8	497	75600	7	528	79017	9	47
40704	6	257	40802	9	354	60038	6	320				75800	1	525	79018	6	47
40705	3	257	40900	2	254	60040	9	321	7			75801	8	524	79019	3	47
40706	0	257	40901	9	255	60041	6	324	71001	6	528, 559	75803	2	528	79020	9	47
40707	7	257	40902	6	254	60042	3	321, 327	71002	3	528, 559	75804	9	528	79021	6	47
40708	4	257	40903	3	255	60044	7	326, 328	71003	0	528, 559	75805	6	479	79022	3	46
40709	1	257	40904	0	254	60045	4	326	71004	7	528, 559	75806	3	525	79023	0	46
40710	7	257, 263	40905	7	255	60046	1	326	71005	4	528, 559	75807	0	525	79024	7	47
40711	4	257, 263	40906	4	254	60270	0	142	71006	1	528, 559	75808	7	529	79025	4	47
40712	1	256	40907	1	255	60310	3	142	71400	7	505	75809	4	529	79026	1	47
40713	8	256	5			60503	9	320	71421	2	550, 575	75810	0	524	79027	8	47
40720	6	270	50002	0	62	60508	4	321	71430	4	493	75820	9	479, 529	79027	8	47
40721	3	270	50205	5	359	60509	1	322	71431	1	484, 551	75821	6	479, 529	79028	5	47
40722	0	257, 270	50210	9	359	60510	7	321	71433	5	505	75822	3	524	79029	2	47
40723	7	257, 270	50305	2	359	60511	4	321	71441	0	369, 427	75823	0	524	79030	8	49, 425
40724	4	270	50400	4	359	60512	1	322	71460	1	347	75824	7	524	79031	5	49, 425
40725	1	270	50600	8	360	60520	6	324	71461	8	347	75825	4	523	79032	2	49, 425
			50601	5	360	60521	3	323	71470	0	346	75830	8	523	79033	9	49, 425
			50602	2	360	60522	0	323	71471	7	346	75831	5	523	79034	6	49, 425
			50603	9	360	60523	7	324	71480	9	346	75832	2	523	79035	3	49, 425
						60524	4	325				75840	7	526	79036	0	49, 425
															79037	7	49, 425

79038	4	48	81700	5	415	82068	5	420	82301	3	422	83466	8	233	83740	9	207
79039	1	48	81701	2	415	82069	2	420	82306	8	422	83467	5	233	83742	3	207
79040	7	48	81702	9	415	82070	8	420	82307	5	274, 275, 278	83468	2	233, 235, 573	83744	7	207
79041	4	48	81704	3	415	82072	2	420	82308	2	274, 275, 278	83469	9	233, 235, 573	83748	5	108, 251, 424
79553	2	62	81706	7	415	82073	9	420	82309	9	274, 275, 278	83479	8	232	83749	2	108, 251, 424
8			81707	4	415	82074	6	420	82310	5	106, 159, 171, 275, 276, 278, 283, 288, 311	83480	4	158, 232, 289	83750	8	251, 424
80023	6	418	81791	3	417	82076	0	420	82312	9	106, 159, 275, 276, 278, 288	83481	1	56, 232	83751	5	251, 424
80024	3	418	81795	1	417	82077	7	420	82314	3	106, 159, 171, 275, 276, 278, 283, 288, 311	83482	8	232	83752	2	251, 424
80025	0	418	81796	8	423	82078	4	420	82316	7	64, 159, 168, 275, 277, 278, 283, 288, 289	83486	6	249	83753	9	108, 109, 251, 424
80026	7	418	81800	2	415	82081	4	420	82318	1	278	83487	3	249	83754	6	251, 424
80027	4	418	81801	9	415	82100	2	422	82319	8	278	83488	0	508	83755	3	251, 424
80028	1	418	81802	6	415	82101	9	419	82328	0	77, 102	83489	7	508	83756	0	251, 424
80029	8	418	81804	0	415	82104	0	419	82338	9	278	83490	3	232	83757	7	108, 109, 251, 424
81000	6	415	81806	4	415	82106	4	419	82345	7	276, 278	83491	0	56, 232	83758	4	251, 424
81095	2	415	81850	7	416	82108	8	419	82346	4	275, 276, 278	83492	7	232	83759	1	109, 251, 424
81100	3	415	81850	7	416	82108	8	419	82347	1	275, 276, 278	83498	9	235	83777	5	243, 271
81101	0	415	81891	0	417	82110	1	419	82350	1	163, 171, 277, 285, 287	83499	6	235	83780	5	243, 271
81102	7	415	81895	8	417	82112	5	419	82352	5	276	83500	9	42, 233	83781	2	243, 265, 271
81104	1	415	81901	6	416	82113	2	419	82354	9	277	83514	6	233	83782	9	243, 271
81106	5	415	81902	3	416	82114	9	419	82355	6	25, 423	83572	6	235	83783	6	243, 271
81108	9	415	81903	0	416	82116	3	419	82356	3	25, 423	83573	3	235	83785	0	239
81109	6	415	81904	7	416	82117	0	419	82357	0	25, 423	83574	0	235	83787	4	239
81116	4	405	81905	4	416	82118	7	419	82359	4	171, 277, 285	83575	7	235	83788	1	92, 239
81117	1	418	81906	1	416	82119	4	419	82360	0	275	83592	4	232	83789	8	239
81118	8	418	81907	8	416	82120	0	419	82361	7	275	83597	9	232	83790	4	239
81191	1	417	81908	5	416	82122	4	419	82362	4	275	83600	6	219, 235, 573	83798	0	243, 271
81195	9	417	81909	2	416	82123	1	419	82363	1	275	83601	3	214, 219, 235, 573	83799	7	239
81198	0	423	81910	8	416	82128	6	419	82370	9	275, 277	83605	1	243, 573	83801	7	250, 431
81199	7	423	81911	5	416	82129	3	419	82371	6	275, 277	83606	8	243, 573	83803	1	250, 431
81200	0	415	81996	2	418	82130	9	419	82394	5	278	83607	5	243, 573	83828	4	238, 247
81201	7	415	81997	9	418	82132	3	419	82395	2	278	83610	5	508	83830	7	238, 247
81202	4	415	81998	6	418	82134	7	419	82419	5	432, 550	83611	2	508	83832	1	56
81204	8	415	81999	3	418	82136	1	419	82420	1	432, 550	83612	9	508	83842	0	249
81206	2	415	82001	2	251, 421, 424	82137	8	419	82440	9	432, 554	83613	6	508	83843	7	249
81208	6	415	82003	6	421	82138	5	419	82441	6	432, 554	83616	7	508	83848	2	250, 313
81209	3	415	82004	3	421	82140	8	419	82828	5	196	83648	8	249	83849	9	250, 313
81292	5	417	82005	0	421	82142	2	419	82829	2	196	83649	5	249	83851	2	250, 313
81295	6	417	82006	7	421	82150	7	419	82831	5	197	83696	9	40, 242	83867	3	71
81296	3	423	82007	4	421	82151	4	419	83310	4	71	83697	6	40, 242	83868	0	71
81300	7	415	82008	1	421	82159	0	419	83311	1	71	83698	3	40, 242	83869	7	233, 241
81301	4	415	82009	8	421	82200	9	422	83401	9	232	83699	0	40, 242	83878	9	247
81302	1	415	82010	4	421	82210	8	394, 397	83402	6	232	83700	3	21, 40, 242, 243, 573	83879	6	247
81304	5	415	82011	1	421	82211	5	84, 402	83403	3	158, 232, 289	83701	0	21, 40, 242, 243, 573	83880	2	106, 242
81306	9	415	82012	8	421	82215	3	394, 397	83405	7	232	83702	7	21, 40, 242	83881	9	242, 243, 573
81308	3	415	82013	5	251, 421, 424	82241	2	64, 275	83406	4	232	83703	4	21, 40, 242	83884	0	155, 233, 569
81391	5	417	82014	2	421	82242	9	275	83407	1	232	83704	1	40, 242, 243, 573	83887	1	248
81395	3	417	82016	6	421	82249	4	77	83408	8	233, 235, 573	83705	8	40, 242, 243, 573	83888	8	248
81400	4	415	82017	3	421	82250	1	77	83409	5	233, 235, 573	83712	6	204	83889	5	248
81401	1	415	82018	0	421	82252	8	77	83410	1	233	83716	4	205	83890	1	153, 155, 240, 569
81402	8	415	82019	7	251, 421, 424	82253	5	77	83414	9	233	83718	8	206	83891	8	153, 155, 240, 569
81404	2	415	82020	3	421	82255	9	76	83415	6	233	83720	1	206	83892	5	153, 240
81406	6	415	82022	7	421	82256	6	76	83417	0	158, 232, 289	83721	8	205	83893	2	153, 240
81408	0	415	82023	4	421	82257	3	76	83418	7	232	83722	5	206	83897	0	250, 431
81492	9	417	82028	9	421	82265	8	76	83419	4	233	83723	2	205	83900	7	236
81495	0	417	82029	6	251, 421, 424	82266	5	76	83433	0	158, 232, 289	83724	9	206	83901	4	236
81502	5	415	82030	2	421	82267	2	76	83434	7	232	83725	6	205	83903	8	236
81504	9	415	82032	6	421	82270	2	422	83450	7	233	83726	3	206	83904	5	236
81506	3	415	82034	0	421	82271	9	422	83451	4	233	83727	0	205	83905	2	236
81591	9	417	82036	4	421	82272	6	422	83452	1	233	83728	7	206	83906	9	236
81595	7	417	82037	1	251, 421, 424	82273	3	422	83453	8	233	83730	0	206	83907	6	236
81602	2	415	82038	8	421	82274	0	405, 422	83454	5	233	83732	4	206	83908	3	236
81604	6	415	82040	1	421	82275	7	422	83455	2	233	83735	5	205	83909	0	236
81606	0	415	82042	5	421	82276	4	422				83739	3	205	83910	6	237
81608	4	415	82050	0	421	82277	1	422							83911	3	237
81611	4	416, 493	82051	7	421	82278	8	422									
81692	3	417	82059	3	421	82279	5	422									
81695	4	417	82064	7	420	82280	1	422									
			82065	4	420	82281	8	422									
			82066	1	420	82300	6	422									

83912	0	237, 247	84133	8	231	84381	3	225	84571	8	202, 203	84815	3	189	85024	8	180
83913	7	237, 247	84134	5	231	84400	1	197	84572	5	203	84816	0	189	85025	5	180
83914	4	237	84135	2	231	84401	8	197	84573	2	203	84819	1	189	85026	2	180
83915	1	237	84158	1	230, 248	84402	5	197	84574	9	203	84820	7	196	85027	9	180
83916	8	237, 573	84161	1	200	84403	2	197	84575	6	202	84821	4	196	85028	6	180
83917	5	237, 573	84170	3	200	84404	9	197	84576	3	202	84824	5	197	85029	3	181
83918	2	42, 237, 573	84171	0	200	84408	7	235	84577	0	203	84825	2	196	85030	9	181
83919	9	237, 573	84172	7	200	84409	4	235	84578	7	203	84826	9	196	85036	1	181
83921	2	237, 573	84174	1	223	84417	9	235	84579	4	203	84827	6	196	85037	8	181
83922	9	237, 573	84177	2	155, 221, 569	84418	6	235	84580	0	203	84828	3	196	85038	5	181
83923	6	237	84178	9	221	84422	3	235	84581	7	202, 203	84829	0	196	85040	8	241
83924	3	237	84179	6	221	84423	0	235	84582	4	203	84830	6	197	85041	5	241
83925	0	237	84180	2	217	84424	7	233	84583	1	213, 572	84831	3	197	85042	2	241
83926	7	237	84181	9	217	84425	4	233	84584	8	213, 572	84835	1	197	85043	9	241
83929	8	204	84182	6	217	84426	1	233	84586	2	213	84836	8	92, 197	85051	4	568, 569
83932	8	206	84185	7	30, 217	84427	8	233	84587	9	213	84837	5	197	85052	1	568, 569
83933	5	206	84186	4	30, 217	84430	8	235	84589	3	213	84860	3	71	85055	2	181
83935	9	206	84187	1	56, 217	84434	6	221	84590	9	213	84862	7	71	85056	9	181
83941	0	207	84188	8	30, 217	84444	5	245	84592	3	214	84863	4	71	85057	6	181
83946	5	207	84189	5	30, 217	84445	2	245	84593	0	214	84900	6	198	85060	6	177
83947	2	207	84200	7	239	84446	9	245	84605	0	212, 572	84901	3	198	85061	3	177
83949	6	207	84205	2	216	84448	3	245	84606	7	212, 572	84902	0	198	85062	0	177
83955	7	218	84206	9	216	84449	0	245	84607	4	212, 572	84903	7	198	85063	7	176
83956	4	218	84207	6	216	84450	6	245	84608	1	212, 572	84904	4	199	85064	4	176
83957	1	218	84209	0	216	84452	0	245	84609	8	212	84905	1	199	85065	1	176
83958	8	218	84215	1	243	84454	4	245	84610	4	212	84906	8	199	85066	8	176
83960	1	238	84216	8	243	84456	8	245	84611	1	212	84907	5	199	85067	5	42, 176
83961	8	238	84217	5	231, 246	84458	2	245	84612	8	212	84908	2	60, 199	85068	2	42, 176
83962	5	238	84220	5	243	84460	5	249	84613	5	212	84909	9	199	85069	9	177
83971	7	218	84221	2	242	84462	9	239	84614	2	212	84910	5	199	85070	5	177
83980	9	218	84230	4	238	84470	4	244, 271	84671	5	190	84911	2	199	85071	2	177
83981	6	219	84231	1	238	84471	1	244, 271	84672	2	190	84912	9	199	85072	9	177
83992	2	219	84244	1	219, 234, 573	84472	8	244, 271	84673	9	190	84920	4	208, 210	85073	6	176
83994	6	219	84245	8	219, 234, 573	84490	2	201	84674	6	190, 191	84921	1	210	85074	3	178
84018	8	246, 271	84251	9	145, 502	84491	9	201	84675	3	190, 191	84922	8	210	85075	0	178
84020	1	250	84253	3	145, 502	84492	6	201	84676	0	190, 191	84923	5	209, 210	85076	7	178
84021	8	250	84257	1	220	84494	0	201	84677	7	190, 191	84924	2	208, 210	85077	4	178
84035	5	250	84258	8	220	84509	1	186	84678	4	190, 191	84925	9	209, 210	85080	4	64, 183, 283
84040	9	241	84259	5	220	84510	7	186	84680	7	192	84926	6	208, 211	85081	1	64, 183, 283
84041	6	241	84295	3	243	84511	4	186	84681	4	192	84927	3	209, 210, 211	85082	8	183
84042	3	241	84300	4	251, 424	84512	1	186	84682	1	192	84928	0	208, 210, 211	85083	5	183
84043	0	241	84301	1	251, 424	84514	5	186	84683	8	192	84929	7	209, 210, 211	85092	7	178
84045	4	151, 503	84302	8	251, 424	84515	2	186	84684	5	193	84930	3	208, 212, 273, 572	85093	4	178
84046	1	25, 235	84303	5	251, 424	84517	6	186	84685	2	193	84931	0	209, 212, 572	85097	2	178
84047	8	25, 27, 235	84304	2	108, 109, 251, 424	84519	0	188	84686	9	193	84932	7	208, 212	85098	9	177
84048	5	25, 235	84305	9	108, 251, 424	84520	6	188	84687	6	193	84933	4	209, 212	85099	6	65, 219, 567
84100	0	222	84306	6	251, 424	84521	3	188	84688	3	193	84934	1	212	85100	9	184
84101	7	222	84307	3	251, 424	84522	0	188	84689	0	193	84935	8	209, 212	85101	6	184
84103	1	224	84308	0	251, 424	84523	7	187	84690	6	193	84936	5	208, 213, 572	85103	0	184
84104	8	224	84309	7	251, 424	84524	4	187	84729	3	224	84937	2	209, 213, 572	85104	7	184, 243, 573
84105	5	224	84310	3	108, 251, 424	84525	1	187	84730	9	224	84938	6	209	85105	4	184, 243, 573
84106	2	224	84311	0	108, 251, 424	84526	8	187	84731	6	222	84942	6	209	85107	8	184, 243, 573
84107	9	223	84329	5	195	84528	2	187	84732	3	222	84943	3	208, 210, 211, 569	85108	5	184
84108	6	223	84331	8	195	84529	9	187, 464	84733	0	222	84944	0	210, 211, 569	85109	2	92, 184
84109	3	223	84335	6	195	84530	5	187, 464	84750	7	244	84948	8	214	85111	5	184
84110	9	223	84337	0	195	84548	0	214	84775	0	246	84950	1	201	85112	2	568
84111	6	223	84348	6	205	84555	8	213, 572	84776	7	246	84951	8	201	85113	9	184
84112	3	223	84349	3	205	84556	5	213, 572	84777	4	246	84958	7	201	85116	0	184
84113	0	223	84351	6	205	84558	9	213, 572	84778	1	246	84959	4	201, 213	85120	7	184, 185
84115	4	223	84353	0	205	84559	6	213, 572	84779	8	246	84962	4	212, 572	85121	4	185
84116	1	223	84355	4	204	84561	9	213, 214, 573	84780	4	246	84963	1	212, 572	85124	5	185
84117	8	224	84365	3	225	84562	6	213, 214, 573	84781	1	246	84964	8	212, 572	85125	2	185
84118	5	224	84366	0	225	84564	0	213	84782	8	246	84965	5	213, 572	85128	3	185
84119	2	224	84377	6	225	84565	7	213	84783	5	246	84966	2	213, 572	85129	0	185
84125	3	230	84378	3	225	84567	1	202	84785	9	239	84967	9	213, 572	85132	0	185
84128	4	230, 248	84379	0	225	84568	8	202	84806	1	189	84968	6	213, 572	85133	7	185
84130	7	231	84380	6	225	84569	5	203	84807	8	189	85021	7	180	85150	4	231
84131	4	231				84570	1	203	84808	5	189				85151	1	231

85200	6	182	88228	7	268	88921	7	534	93170	1	483	93332	3	462
85201	3	182	88229	4	268	88922	4	534	93171	8	473	93333	0	462
85202	0	182	88256	0	552	88923	1	534	93173	2	474	93334	7	465
85203	7	182	88271	3	550	88928	6	534	93174	9	474	93335	4	465
85204	4	182	88285	0	423	88929	3	536	93175	6	474	93336	1	464
85205	1	182	88287	4	558	88930	9	536	93176	3	473	93337	8	464
85206	8	182	88288	1	558	88932	3	534	93179	4	467	93338	5	464
85207	5	182	88300	0	80, 408	88933	0	534	93180	0	470	93345	3	143, 461
85208	2	182	88301	7	80, 408	88935	4	535	93181	7	470	93346	0	460
85211	2	214	88302	4	81, 409	88937	8	535	93182	4	470	93347	7	472
85225	9	70, 500	88303	1	81, 83, 409, 411	88938	5	535	93189	3	484, 551	93348	4	472
85230	3	94, 215, 293	88304	8	81, 409	88939	2	535	93190	9	479	93349	1	472
85231	0	94, 215, 293	88305	5	81, 83, 409, 411	88940	8	535	93191	6	477	93350	7	466
85232	7	112	88306	2	82, 410	88941	5	535	93192	3	477	93351	4	468
85240	2	244, 271	88307	9	82, 410	88942	2	535	93200	5	476	93352	1	468
85241	9	244, 271	88308	6	82, 83, 410, 411	88946	0	536	93201	2	466	93353	8	468
85242	6	244, 271	88309	3	82, 410	88947	7	536	93203	6	466	93354	5	468
85243	3	244, 271	88310	9	83, 411	9			93204	3	463, 466	93355	2	468
85244	0	244, 271	88311	6	83, 411	88948	4	536	93211	1	467	93356	9	469
85250	1	240	88312	3	80, 83, 408, 411	88949	1	537, 554	93212	8	467	93357	6	469
85251	8	240	88313	0	81, 409	88950	7	545	93214	2	484, 551	93358	3	470
85252	5	240	88314	7	81, 409	88951	4	545	93220	3	476	93359	0	299, 480
85260	0	234, 573	88315	4	82, 83, 410, 411	90902	1	34	93225	8	548	93360	6	470
85261	7	234, 573	88316	1	82, 410	93034	6	471	93226	5	548	93361	3	470
85266	2	234, 573	88317	8	83, 411	93090	2	126, 453	93230	2	126	93362	0	470
85267	9	234, 573	88320	8	83, 411	93091	9	126, 453	93250	0	549	93364	4	462
85270	9	179	88598	1	555	93092	6	126, 453	93251	7	549	93365	1	462
85271	6	179	88608	7	521	93093	3	126, 453	93252	4	549	93366	8	467
85272	3	179	88609	4	555	93101	5	480	93253	1	549	93367	5	460
85273	0	179	88618	6	538	93102	2	481	93254	8	549	93368	2	471
85274	7	177	88627	8	555	93105	3	126, 453	93255	5	549	93369	9	471
85275	4	176	88628	5	555	93110	7	481	93256	2	549	93371	2	463
85276	1	179	88636	0	555	93111	4	481	93257	9	549	93372	9	463
85277	8	179	88637	7	521	93112	1	469	93258	6	549	93373	6	463
85278	5	179	88639	1	538	93114	5	481	93259	3	548	93374	3	463
85279	2	179	88640	7	520	93116	9	469	93260	9	548	93375	0	465
85290	7	200	88642	1	520	93120	6	469	93261	6	548	93377	4	482
85291	4	200	88643	8	525	93121	3	469	93270	8	549	93380	4	475
85300	3	174	88644	5	525	93122	0	482	93271	5	549	93381	1	475
85301	0	174	88645	2	525	93124	4	483	93272	2	549	93382	8	475
85302	7	174	88688	9	541	93125	1	482	93273	9	549	93383	5	475
85303	4	174	88717	6	539	93129	9	471	93274	6	549	93384	2	475
85304	1	174	88810	4	530	93134	3	471	93275	3	549	93385	9	475
85305	8	175	88811	1	530	93138	1	466	93280	7	550	93386	6	475
85306	5	175	88823	4	530	93139	8	466	93281	4	550	93390	3	475
85307	2	175	88826	5	531	93140	4	466	93300	2	472	93391	0	475
85308	9	175	88827	2	531	93141	1	480	93302	6	482	93392	7	475
85309	6	175	88829	6	532	93144	2	480	93303	3	474	93393	4	475
85310	2	175	88834	0	532	93145	9	480	93304	0	474	93394	1	475
85311	9	175	88836	4	532	93146	6	480	93306	4	473	93395	8	475
85312	6	175	88839	5	532	93147	3	480	93307	1	473	93398	9	465
85320	1	194	88840	1	533	93148	0	480	93310	1	461	93399	6	465
85321	8	194	88843	2	473, 533	93152	7	471	93311	8	461	93400	9	465
85322	5	194	88846	3	473, 531	93153	4	471	93312	5	472	98120	1	42
85323	2	194	88850	0	531	93154	1	549	93313	2	472			
85323	2	194	88853	1	533	93155	8	548	93318	7	473, 539			
85324	9	194	88855	5	558	93156	5	548	93321	7	91, 429			
88080	1	553	88900	2	558	93157	2	548	93322	4	461			
88081	8	553	88901	9	558	93160	2	481	93323	1	461			
88090	0	554	88902	6	558	93161	9	481	93324	8	468			
88099	3	537	88903	3	559	93163	3	549	93325	5	466			
88220	1	268	88911	8	558	93164	0	468	93326	2	467			
88221	8	268	88912	5	558	93165	7	468	93327	9	464			
88222	5	268	88920	0	534	93166	4	474	93328	6	464			
88223	2	268				93167	1	474	93329	3	464			
88224	9	268				93168	8	474	93330	9	443, 460			
88225	6	268				93169	5	474	93331	6	462			
88226	3	268												
88227	0	268												



buffet | tabletop | bar



DE Impressum

Herausgeber: Assheuer + Pott GmbH & Co. KG, Talweg 11, 59846 Sundern, Tel. +49 2933 97350, info@aps-germany.de, www.aps-germany.de
Gestaltung: Assheuer + Pott GmbH & Co. KG - Druck: Westdeutsche Verlags- und Druckerei GmbH, Kurhessenstraße 4-6, 64546 Mörfelden-Walldorf
Wir behalten uns das Recht vor, die angegebenen Spezifikationen jederzeit zu ändern. Irrtum, Druckfehler und technische Änderungen vorbehalten. Artikelbeschreibungen sowie Abbildungen und Fotodarstellungen sind ohne Gewähr. Alle Angebote ohne Dekoration. Alle Preise verstehen sich unverbindlich (UVP) in Euro zuzüglich der gesetzlichen Mehrwertsteuer.
© 2024 - Die Vervielfältigung dieses Kataloges - auch wenn partial - muss ausschließlich von der Assheuer + Pott GmbH & Co. KG genehmigt werden.
Bildnachweis: Niklas Thiemann Fotodesign · Studio CASA · Stoll GmbH – Studio für Fotografie · track by track GmbH · iStock · Envato Elements Pty Ltd.

GB Imprint

Editor: Assheuer + Pott GmbH & Co. KG, Talweg 11, 59846 Sundern, Germany, Tel. +49 2933 97350, info@aps-germany.de, www.aps-germany.de
Design: Assheuer + Pott GmbH & Co. KG - Print: Westdeutsche Verlags- und Druckerei GmbH, Kurhessenstraße 4-6, 64546 Mörfelden-Walldorf, Germany
We reserve the right to alter at any time the specifications stated without notice. Errors, printing error and technical changes reserved. Item description as well as images and illustrations are without guaranty. All offers are without decoration. All prices are without commitment (RRP) in Euro and exclude the legal VAT prescribed by law.
© 2024 - This catalogue may not be reproduced in whole or in part unless specific prior written authorization of Assheuer + Pott GmbH & Co. KG.
Picture credits: Niklas Thiemann Fotodesign · Studio CASA · Stoll GmbH – Studio für Fotografie · track by track GmbH · iStock · Envato Elements Pty Ltd.

ES Impressum

Editor: Assheuer + Pott GmbH & Co. KG, Talweg 11, 59846 Sundern, Alemania, Tel. +49 2933 97350, info@aps-germany.de, www.aps-germany.de
Diseño gráfico: Assheuer + Pott GmbH & Co. KG - Impresión: Westdeutsche Verlags- und Druckerei GmbH, Kurhessenstraße 4-6, 64546 Mörfelden-Walldorf, Alemania
Nos reservamos el derecho de efectuar modificaciones en cualquier momento, sin aviso previo. Salvo errores de imprenta o impresión o cambios técnicos. La descripción de los artículos, sus imágenes e ilustraciones son sin garantía. Los artículos se ofrecen sin decoración. Todos los precios indicados son precios sugeridos (PVR) en euros y a dichos precios se deberá añadir el impuesto sobre el valor añadido legal vigente.
© 2024 - Todas las reproducciones, aunque parciales, de este catálogo tienen que ser autorizadas por escrito por Assheuer + Pott GmbH & Co. KG.
Derechos de la imagen: Niklas Thiemann Fotodesign · Studio CASA · Stoll GmbH – Studio für Fotografie · track by track GmbH · iStock · Envato Elements Pty Ltd.

FR Impressum

Éditeur: Assheuer + Pott GmbH & Co. KG, Talweg 11, 59846 Sundern, Allemagne, Tel. +49 2933 97350, info@aps-germany.de, www.aps-germany.de
Design: Assheuer + Pott GmbH & Co. KG - Impression: Westdeutsche Verlags- und Druckerei GmbH, Kurhessenstraße 4-6, 64546 Mörfelden-Walldorf, Allemagne
Nous nous réservons le droit de modifier à tout moment les spécifications. Toutes erreurs, fautes d'impression et modifications techniques sont réservées. Les descriptions d'articles, les illustrations et les photos sont sans garantie. Toutes les articles s'entendent hors décoration. Tous les prix sont donnés sans engagement (PVC) et s'entendent en Euro et T.V.A. légale en vigueur non incluse.
© 2024 - Toute reproduction même partielle de ce catalogue est interdite sauf autorisation expresse de Assheuer + Pott GmbH & Co. KG.
Crédit photo: Niklas Thiemann Fotodesign · Studio CASA · Stoll GmbH – Studio für Fotografie · track by track GmbH · iStock · Envato Elements Pty Ltd.



buffet | tabletop | bar

Assheuer + Pott GmbH & Co. KG
Talweg 11, 59846 Sundern / Germany

aps-germany.de

CATALOGUE NO 50



no. 3778

